

VitroA

PRO
NATURE



PRO

NATURE

PRO

VitrA, mimarlara ve iç mimarlara ilham verecek, profesyonellerin hayallerini tasarımlarına yardımcı olacak, sayısız ürün, renk, desen, malzeme, yüzey özelliği ve çözüm barındıran VitrA PRO karo seramik koleksiyonunu daha da zenginleştirdi.

VitrA PRO karo seramik koleksiyonunda; doğadan ilham alan malzeme seçenekleri ile PRO Nature, renk çeşitliliği, farklı yüzeyler ve dayanıklılık sunan PRO Technic ve bu ikisinden seçilmiş ürünlerle, kullanım yerine özel havuz ve dış cephe çözümlerini bir araya getiren PRO Solutions bulunuyor.

VitrA further enriched its VitrA PRO ceramic tile collection featuring numerous products, colors, patterns, materials, surface textures and solutions, which will inspire architects and interior designers and help the professionals to design their dreams.

Included in VitrA PRO ceramic tile collection are PRO Nature with material alternatives inspired by nature, PRO Technic with color diversity, different surfaces and durability, in addition to PRO Solutions with site-specific solutions for pools and facades with products collated from these two lines.

PRO NATURE

Doğal malzeme dokulu karolar
Natural material textured tiles

Beton / Concrete
Taş / Stone
Ahşap / Wood
Mermer / Marble
Seramik / Ceramic

PRO TECHNIC

Renkler, yüzeyler, fullbody porselenler
ve teknik karolar

Colors, surfaces, fullbody
porcelains and technic tiles

Color
Function
Matrix

PRO SOLUTIONS

PRO Nature ve PRO Technic ürünlerinden oluşturulmuş
entegre karo çözümleri.

Integrated tiles solutions collated from PRO Nature and
PRO Technic products.

Pool
Facade

PRO

NATURE

BETON SADELİĞİ

26

PURE CONCRETE

★ URBANCRETE	28
★ METALCRETE	38
★ ULTRA 2.0	44
ASH&BURN	50
NEWCON	56
CLAY-CEMENT	68
BRICX	80
ICE & SMOKE	88
ICE & SMOKE PARLAK / GLOSSY	94
ICE & SMOKE - S	100
CEMENT-TECH	108
CEMENT-TECH - S	114
PICCADILLY	120
UPTOWN	126
METRO	132
VADO	140
ESSENCE	148
MICROTEC	154
NITRIUM	160
TERRE	166
TRUVA	172
CLAYART	178
LUGANO	184
MILERA	190
HANDCRAFTED	196
BLOOM	202
COSY	212
BLACK SWAN	218

TAŞ ZAMANI

224

STONE CODE

★ CARDOSTONE	226
★ CEPPOSTONE	232
★ STONELEVEL	238
URBAN BLUE	244
SLATEMIX	252
CITYRUG	258
TECH-SLATE	264
BRITISH STONE	270
LOMBARDY	280
MERIDIEN	286
PIETRA PIENZA	292
RAINFOREST	292
URBAN QUARZITE	304
QUARZITE	310
ARARAT	316
STONEWAY	322
STIX	328
LIMESTAR	334
TEXTONE	340
QUARZ	346
PANGA	354
PIETRA PIENZA - S	360

İÇİNDEKİLER 1

INDEX 1

AHŞAP TUTKUSU

368

WOOD OBSESSION

★ URBANWOOD	370
ASPENWOOD	376
WOODMIX	384
PERA	390
SAMBA	396
WOODPLUS	402
PROVENCE	408

MERMER RÜYASI

414

MARBLE DREAM

MARMORI	416
CALACATTA	424
STATUA	430
METAMARMO	436
VERSUS XL	442
İNSİDE XL	448
BERN	454
B&W STAR XL	460
B&W STAR L	466
OPALINE	472
TUNDRA SKY	478
ATTRACTION	484
CELEBRATION	490
VERSUS M	496
INSIDE M	502
ECCENTRIC M	508
ETHEREAL M	514
ETHEREAL XS	520
BLAST	526
DECOCREAM	532
VERSUS S	538
INSIDE S	544
CELEBRATION S	550

SERAMİK KÜLTÜRÜ

552

CERAMIC CULTURE

★ SCALE	558
HOMEMADE X	562
PEARLART	568
STUDIO - MIX	574
STUDIO - TAB	580
STUDIO - TEX	586
STUDIO - PLATE	592
FUTURA - XL	598
MILLENIUM	602
CRAFTMIX	608
HOMEMADE	614
FUTURA - M	620
ELEGANT	624
DÜZ RENKLER / PLAIN COLORS	630
METRO TILES	636
COLOR LINE	644
DAY-TO-DAY	650

Teknik Bilgiler

656

Technical Information

PRO

NATURE

- ARARAT
- ASH&BURN
- ASPENWOOD
- ATTRACTION
- BERN
- BLACK & WHITE STAR - XL
- BLACK & WHITE STAR - L
- BLACK SWAN
- BLAST
- BLOOM
- BRICX
- BRITISH STONE
- CALACATTA
- ★ CARDOSTONE
- CELEBRATION
- CELEBRATION - S
- CEMENT-TECH
- CEMENT-TECH - S
- ★ CEPPOSTONE
- CITYRUG
- CLAY-CEMENT
- CLAYART
- COLOR LINE
- COSY
- CRAFTMIX
- DAY-TO-DAY
- DECOCREAM
- DÜZ RENKLER / PLAIN COLORS
- ECCENTRIC - M
- ELEGANT
- ESSENCE
- ETHEREAL M
- ETHEREAL - XS
- FUTURA - M
- FUTURA - XL
- HANDCRAFTED
- HOMEMADE
- HOMEMADE X
- ICE & SMOKE
- ICE & SMOKE - S
- ICE & SMOKE PARLAK / GLOSSY
- INSIDE - M
- INSIDE - S
- INSIDE - XL
- LIMESTAR
- LOMBARDY
- LUGANO
- MARMORI
- MERIDIEN
- ★ METALCRETE
- METAMARMO
- METRO
- METRO TILES

İÇİNDEKİLER 2

INDEX 2

- MICROTEC
- MILERA
- MILLENIUM
- NEWCON
- NITRIUM
- OPALINE
- PANGA
- PEARLART
- PERA
- PICCADILLY
- PIETRA PIENZA
- PIETRA PIENZA - S
- PROVENCE
- QUARZ
- QUARZITE
- RAINFOREST
- SAMBA
- ★ SCALE
- SLATEMIX
- STATUA
- STIX
- ★ STONELEVEL
- STONEWAY
- STUDIO - MIX
- STUDIO - PLATE
- STUDIO - TAB
- STUDIO - TEX
- TECH-SLATE
- TERRE
- TEXTONE
- TRUVA
- TUNDRA SKY
- UPTOWN
- URBAN BLUE
- URBAN QUARZITE
- ★ URBANCRETE
- ★ URBANWOOD
- ★ ULTRA 2.0
- VADO
- VERSUS - M
- VERSUS - S
- VERSUS - XL
- WOODMIX
- WOODPLUS
- MARMORİ

	DUVAR WALL	COLORBODY PORSELEN COLORBODY PORCELAIN
BETON SADELİĞİ PURE CONCRETE	CLAYART LUGANO MILERA METRO HANDCRAFTED BLOOM COSY ICE&SMOKE S CEMENT-TECH S	URBANCRETE METALCRETE ULTRA 2.0 ASH & BURN NEWCON CLAY - CEMENT ICE & SMOKE MAT CEMENT - TECH PICCADDILLY UPTOWN TERRANOVA ULTRA 2.0 METRO LUGANO MILERA
TAŞ ZAMANI STONE CODE	BRITISH STONE STIX LIMESTAR TEXTONE QUARZ PANGA PIETRA PIENZA S	CARDOSTONE CEPPOSTONE STONELEVEL URBAN BLUE TECH - SLATE BRITISH STONE LOMBARDY PIETRA PIENZA RAINFOREST URBAN QUARZITE QUARZITE ARARAT
AHŞAP TUTKUSU WOOD OBSESSION	PROVENCE	WOODMIX
MERMER RÜYASI MARBLE DREAM	STATUA METAMARMO VERSUS XL INSİDE XL BERN B&W STAR XL B&W STAR L OPALİNE TUNDRA SKY ATTRACTION CELEBRATION CITYRUG VERSUS M INSIDE M ECCENTRIC M ETHEREAL M ETHEREAL XS BLAST DECOCREAM VERSUS S INSIDE S CELEBRATION S	CALACATTA VERSUS XL MARFIM
SERAMİK KÜLTÜRÜ CERAMIC CULTURE	HOMEMADE X PEARLART STUDIO - MIX STUDIO - TAB STUDIO - TEX STUDIO - PLATE FUTURA - XL MILLENNIUM CRAFTMIX HOMEMADE FUTURA - M ELEGANT DÜZ RENKLER / PLAIN COLORS	SCALE METRO TILES COLOR LINE DAY-TO-DAY

SIRLI PORSELEN

GLAZED PORCELAIN

VADO
ICE & SMOKE PARLAK /
GLOSSY
NITRIUM
TERRE
BLOOM
ICE & SMOKE S
CEMENT - TECH S
STUDIO MIX
STUDIO PLATE

SERAMİK YER KAROSU

CERAMIC FLOOR TILES

TERRE
TRUVA
BLACK SWAN

DOUBLE CHARGE PORSELEN

DOUBLE CHARGE PORCELAIN

ESSENCE
MICROTEC

STONEWAY
PANGA
QUARZ
PIETRA PIENZA S
CITYRUG
MERIDIEN

PANGA

URBANWOOD
ASPENWOOD
PERA
SAMBA
WOODPLUS

MARMORI
STATUA
METAMARMO
VERSUS XL
INSIDE XL
OPALINE
TUNDRA SKY
CELEBRATION
ATTRACTION
VERSUS M
ETHEREAL XS
BLAST
VERSUS S
INSIDE S
CELEBRATION S

BERN
OPALINE
TUNDRA SKY
ATTRACTION
CELEBRATION
VERSUS M
INSIDE M
ECCENTRIC M
ETHEREAL M
ETHEREAL XS

ELEGANT

DUVAR KAROLARI

WALL TILES

33x100	40x80	25x70	30x60	20x50	25x40
CLAYART	B&W STAR XL	ATTRACTION	BLAST	BLOOM	CELEBRATION S
DÜZ RENKLER	BERN	B&W STAR L	BLOOM	DÜZ RENKLER	CEMENT-TECH S
PLAIN COLORS	LUGANO	CELEBRATION	CRAFTMIX	PLAIN COLORS	COSY
FUTURA - XL	MILERA	DÜZ RENKLER	DECOCREAM	VOYAGE	DÜZ RENKLER
INSIDE - XL		PLAIN COLORS	DÜZ RENKLER		PLAIN COLORS
METAMARMO		OPALINE	PLAIN COLORS		ELEGANT
PEARLART		TUNDRA SKY	ECCENTRIC - M		ICE & SMOKE S
PROVENCE			ETHEREAL - M		INSIDE S
STATUA			FUTURA - M		PANGA
STUDIO - MIX			HANDCRAFTED		PIETRA PIENZA S
STUDIO - PLATE			INSIDE - M		QUARZ
STUDIO - TAB			LIMESTAR		TEXTONE
STUDIO - TEX			MILLENIUM		VERSUS S
VERSUS - XL			STIX		
			VERSUS - M		

PORSELEN KAROLAR

PORCELAIN TILES

60x120	30x120	20x120	45x90	22.5x90	15x90	M80x80
BRITISH STONE	NEWCON	ASPENWOOD	BRITISH STONE	FANGO MIX	PICCADILLY	URBANCRETE
CALACATTA	WOODMIX	BRITISH STONE	METRO	UPTOWN	TECH - SLATE	CARDOSTONE
CARDOSTONE		CALACATTA	PICCADILLY	WOODPLUS	UPTOWN	CEPPOSTONE
CEPPOSTONE		PERA	PIETRA PIENZA		WOODPLUS	METALCRETE
LOMBARDY		SAMBA	TECH - SLATE			STONELEVEL
MARFIM		WOODMIX	UPTOWN			ULTRA 2.0
MARMORI		URBANWOOD				URBAN BLUE
NEWCON						NEWCON
NITRIUM						ASH AND BURN
ULTRA 2.0						ICE AND SMOKE
URBANCRETE						CEMENT-TECH
URBAN QUARZITE						CALACATTA
WOODMIX						

SERAMİK YER KAROLARI

CERAMIC FLOOR TILES

60x60	33x33	2.5x2.5	5x5	2.5x5	5x10	10x10
ATTRACTION	BLACK SWAN	COLOR LINE	COLOR LINE	METRO TILES	METRO TILES	METRO TILES
BERN	BLOOM					
CELEBRATION	ETHEREAL XS					
ECCENTRIC M	PANGA					
ETHEREAL M	TRUVA					
INSIDE M	VADO					
OPALINE						
TUNDRA SKY						
VERSUS M						

20x30DÜZ RENKLER
PLAIN COLORS**20x25**DÜZ RENKLER
PLAIN COLORS
ETHEREAL XS**10x30**HOMEMADE
HOMEMADE-X**40x80**ASH & BURN
CALACATTA
CARDOSTONE
CEPPOSTONE
CEMENT - TECH
ICE & SMOKE
(MAT / MATT)
METALCRETE
STONELEVEL
URBANCRETE
URBAN BLUE**60x60**ARARAT
ASH & BURN
ATTRACTION
BRITISH STONE
CALACATTA
CARDOSTONE
CELEBRATION
CEMENT - TECH
CEPPOSTONE
CLAY - CEMENT
ESSENCE
ETHEREAL M
ICE & SMOKE
(MAT / MATT)
ICE & SMOKE
(PARLAK / GLOSSY)
INSIDE XL
LOMBARDY
LUGANO
MARMORİ
MERIDIEN
METAMARMO
METRO
MICROTEC
MILERA
NEWCONNITRIUM
OPALINE
PICCADILLY
PIETRA PIENZA
RAINFOREST
STATUA
STONELEVEL
STUDIO-MIX
STUDIO-PLATE
TECH - SLATE
TUNDRA SKY
ULTRA 2.0
UPTOWN
URBAN QUARZITE
URBANCRETE
VADO
VERSUS XL**30x60**ARARAT
ASH AND BURN
BRITISH STONE
CLAY-CEMENT
ESSENCE
ICE AND SMOKE
LOMBARDY
MARMORI
MERIDIEN
METRO
MICROTEC
NEWCON
PICCADILLY
PIETRA PIENZA
QUARZITE
RAINFOREST
STONELEVEL
TECH-SLATE
ULTRA 2.0
UPTOWN
URBANCRETE
VADO**45x45**LOMBARDY
BLAST
BLOOM
CELEBRATION S
CEMENT - TECH S
ELEGANT
ETHEREAL M
ICE & SMOKE S
INSIDE S
METRO
NEWCON
PIETRA PIENZA S
QUARZ
STONEWAY
TEXTONE
TERRE
TEXTONE
ULTRA 2.0
VADO
VERSUS S**30x30**ESSENCE
METRO
NEWCON
VADO**21x24 HEXAGON**ASH&BURN
CARDOSTONE
CITYRUG
ICE & SMOKE
URBANCRETE**7,5x30**ASH & BURN
BRICX
ICE & SMOKE
SLATEMIX**15x15**ASH & BURN
ICE & SMOKE
SLATEMIX**5x5**LOMBARDY
MERIDIEN
NEWCON
VADO**100x300**

SCALE

100x100

SCALE

10x20

METRO TILES

10x30

METRO TILES

20x20

METRO TILES

30x30

DAY-TO-DAY

PRO

NATURE

DOĞA İLE HAYALLERİNİ TASARLA

Tasarladığın yapının nefes almasına izin ver, doğanın içine sızdığı, damarlarında dolaştığı, duvarlarında soluk aldığı ve zeminlerinde gezindiği bir yapıda, insana doğanın bir parçası olarak hissedebileceği yaşam alanları yarat. VitrA, PRO Nature karo seramiklerinde dokuları doğadan aldı, farklı ihtiyaç ve beklentiler için yenilikçi çözümler geliştirdi. Aklın ve tecrübenin ışığında çevre dostu teknolojileri, özgün ve yaratıcı tasarımlarla harmanladı. Mermer, taş, ahşap, metal, beton ve seramik gibi temel yapı malzemelerini, farklı ebat, renk ve desenlerle zenginleştirerek trendlerle paralel seriler hazırladı. Yaşayan mekânlar yaratmanın ipuçlarını da, binlerce insanın gün boyu kullanacağı mekânların dayanıklı çözümünü de PRO Nature koleksiyonunda topladı.

DESIGN YOUR DREAMS WITH NATURE

Let the structure you design breath. Create living spaces where people can feel like a part of nature, a structure where the nature circulates in its veins, breathes through its walls and wander about on its floors. VitrA derived the textures in PRO Nature tiles from the nature and developed innovative solutions for different needs and expectations. It blended the eco-friendly technologies with unique and creative designs, in the light of mind and experience. It prepared series in line with trends, enriching the basic building materials such as marble, stone, wood, metal, concrete and ceramic with different sizes, colors and patterns. In PRO Nature collection, VitrA gathered the tips of creating living spaces as well as durable solutions to buildings where thousands of people can enjoy all day long.

BETON SADELİĞİ
PURE CONCRETE

TAŞ ZAMANI
STONE CODE

AHŞAP TUTKUSU
WOOD OBSESSION

MERMER RÜYASI
MARBLE DREAM

SERAMİK KÜLTÜRÜ
CERAMIC CULTURE



PRO

NATURE

SICAK MEKÂNLAR YARATIR

VitrA PRO Nature porselen karolar kendine özgü doğal dokusuyla; konut, restoran, kafe, otel ve benzeri tüm mekânlarda size ancak doğal malzemenin sağlayabileceği sıcaklıkta atmosfere sahip, canlı ve samimi tasarımlar yaratma özgürlüğü sunar.

IT CREATES WARM SPACES

VitrA PRO Nature porcelain tiles offer you the freedom of creating vivid and intimate designs with an atmosphere as warm as the natural material can only offer you, in all spaces such as residence, restaurant, café, hotel, etc., with their unique natural textures.





PRO

NATURE

DAYANIKLIDIR, ÇİZİLMEZ

VitrA PRO Nature porselen karolarının en önemli özelliklerinden biri üstün sağlamlık ve dayanıklılık performansıdır. Porselen karolar doğal malzemelerin aksine sert yüzeylerle çizilmez, darbeye ve aşırı yüke dayanıklıdır; bu nedenle alışveriş merkezi, kafe, restoran ve ofis gibi insan trafiğinin, ayrıca sandalye ve masa gibi yüzey çizen eşyaların yoğun olduğu mekânlarda güvenle tercih edilebilir.

DURABLE, SCRATCH-PROOF

One of the most remarkable features of VitrA PRO Nature porcelain tiles is paramount strength and durability performance. Porcelain tiles do not get scratched by hard surfaces, unlike the natural materials and resistant against shocks and overloads. Therefore, it can be safely preferred in high-traffic areas such as shopping centres, cafes, restaurants and offices as well as in spaces where surface-scratching items such as chairs and tables are heavily used.



PRO

NATURE

HİJYENİKTİR, KOLAY TEMİZLENİR

VitrA PRO Nature porselen karolarda temizlik son derece kolaydır, pek çok doğal malzemenin aksine temizlik kimyasallarına karşı dayanıklıdır. Bu nedenle konutlar, eğitim kurumları, hastaneler ve sık temizlik gerektiren yoğun trafikli mekânlar için hijyen özelliği ile güvenle kullanılabilir.

HYGIENIC, EASILY CLEANED

VitrA PRO Nature porcelain tile are extremely easy to clean and resistant against cleaning chemicals, in comparison with many natural materials. Therefore, it can safely be used in educational establishments, hospitals and in high-traffic areas which require frequent cleaning, thanks to its hygienic feature.



PRO

NATURE

UZUN ÖMÜRLÜDÜR, RENGİ SOLMAZ

VitrA PRO Nature porselen karolar tam bir güneş dostudur, hem yer hem de duvar kullanımında ahşap gibi doğal malzemelerde olabileceği gibi güneşten etkilenmez, her koşulda ilk günkü göz alıcı halini korur. Bu nedenle ev, ofis, mağaza gibi iç mekânlar ile balkon ve teras gibi dış alanlarda sorunsuzca döşenir ve uzun yıllar yeni görünümünü kaybetmez.

LONG-LASTING, COLOR-FAST

VitrA PRO Nature porcelain tiles are quite sun friendly, not affected by the sun as might be in the natural materials such as wood, both in floor and wall applications and maintains their brilliant appearance just like the first day, under all conditions. Hence, they are used hassle-free indoor such as homes, offices and shops as well as outdoor such as balconies and terraces and do not lose their new look for many years.



PRO

NATURE

DIŐ MEKÂNLARDA GÜVENLE KULLANILIR

VitrA PRO Nature porselen karo sađlam ve dayanıklı olma özelliđiyle dıŐ mekânlarda uzun yıllar problemsiz kullanılabilen bir üründür. Sıcak ve sođuk ısı deđişimlerinden etkilenmez; yađmur, kar ve dona dayanıklıdır. Bahçe ve teras gibi dıŐ mekânlara için idealdir.

SAFELY USED OUTDOOR

VitrA PRO Nature porcelain tile is a product which can be used outdoor hassle-free for many years, as it is strong and durable. It is not affected by changes in hot and cold temperatures, resistant against rain, snow and frost. Ideal for outdoor spaces such as courts and terraces.



BUNNE

CONCRETE

BETON SADELİĞİ

Beton, yapıların ruhu, mimarının en saf hali. Sadeliği, mimari derinliği ve dayanıklılığı harmanlayan beton, tasarımın en rafine halini yaşam alanlarınıza taşıyor.

Concrete is the spirit of structures, the purest state of the architecture. Combining the simplicity, architectural profoundness and endurance, the concrete takes the most refined state of design to your living spaces.



URBANCRETE





URBANCRETE





PRO

NATURE

URBANCRETE

Brüt betonun güçlü ve zamansız karakterini çağdaş mimariye katan colorbody porselen koleksiyonu. Urbancrete, sofistike bir karma sunan ColorCode yaklaşımının sıcak ve soğuk renklerini, etnik ve geometrik altıgen dekorlarla tamamlıyor. Urbancrete, dayanıklı colobody bünyesi, güçlü kaydırmazlık özelliği ve temizlenme kolaylığı ile yüksek trafikli genel kullanım alanlarında uzun yıllar kullanım sağlıyor.

A colorbody porcelain collection that infuses a modern, architectural look into the timeless and robust character of exposed concrete. Urbancrete completes the sophisticated mix of warm and cold colors of the ColorCode approach with ethnic and geometric hexagonal decorative tiles. Highly durable, with a powerful anti-slip surface that is easy to clean, the Urbancrete porcelain collection can be used in high traffic areas for many years.

Porselen Karolar / Porcelain Tiles

Bünye / Body Type

Colorbody Porselen / Colorbody Porcelain

Fon Ebatları / Basic Tile Sizes

60x120 cm (R 597x1197 mm)

80x80 cm (R 797x797 mm)

40x80 cm (R 397x797 mm)

60x60 cm (R 597x597 mm)

30x60 cm (R 297x597 mm)

Sırlı porselen / Glazed Porcelain

Fon Ebatları / Basic Tile Sizes

21x24 cm Altıgen/Hexagon (210x241mm)

Yüzey Alternatifleri / Surface Alternatives

R10A

R11C

R9 LPR

Fon Renkleri / Basic Tile Colors

Beyaz / White

Gri / Grey

Koyu Gri / Dark Grey

Vizon / Mink

Koyu Grej / Dark Greige

Kullanım Alanları / Usage Areas

Konut / Residential

Ticari Alan / Commercial

Döşeme Alanları / Tiling Areas

Yer / Floor

Duvar / Wall

Dona Dayanım / Frost Resistance

Var / Available

Desen Farklılaşması / Shade Variation Classification

V2

Baskı Teknolojisi / Printing Technology

ReaLook

Ürün Standardı / Product Standard

EN14411 Group Bla

Dip Notlar / Footnotes

F H R



Porselen
Porcelain



Yer Karosu
Floor Tile



Duvar Karosu
Wall Tile



Dış Cephe
Facade



Konut
Residential



Ticari Alan
Commercial



Havuz çevresi
Pool Surrounding



Dona Dayanım
Frost Resistance



Desen Farklılaşması
Shade Variation



Mat
Matt



R9 Lappato



Soft R10



Rektifiyeli
Rectified



Modülerlik
Modularity



Küçük Ebat
Mini Size



Yeni
Novelty

URBANCRETE

Porselen Karolar / Porcelain Tiles



Beyaz / White

60x120	R10A	K947465R0001VTE0
80x80	R10A	K947182R0001VTE0
40x80	R10A	K947190R0001VTE0
60x60	R10A	K947085R0001VTE0
30x60	R10A	K947237R0001VTE0
60x60	R11C	K947196R0001VTE0
30x60	R11C	K947242R0001VTE0
80x80	R9 LPR	K947182LPR01VTE0
40x80	R9 LPR	K947190LPR01VTE0
60x60	R9 LPR	K947085LPR01VTE0
30x60	R9 LPR	K947237LPR01VTE0



Gri / Grey

60x120	R10A	K947468R0001VTE0
80x80	R10A	K947083R0001VTE0
40x80	R10A	K947188R0001VTE0
60x60	R10A	K947186R0001VTE0
30x60	R10A	K947235R0001VTE0
60x60	R11C	K947194R0001VTE0
30x60	R11C	K947240R0001VTE0
80x80	R9 LPR	K947083LPR01VTE0
40x80	R9 LPR	K947188LPR01VTE0
60x60	R9 LPR	K947186LPR01VTE0
30x60	R9 LPR	K947235LPR01VTE0



Koyu Gri / Dark Grey

60x120	R10A	K947466R0001VTE0
80x80	R10A	K947183R0001VTE0
40x80	R10A	K947191R0001VTE0
60x60	R10A	K947086R0001VTE0
30x60	R10A	K947238R0001VTE0
60x60	R11C	K947197R0001VTE0
30x60	R11C	K947243R0001VTE0
80x80	R9 LPR	K947183LPR01VTE0
40x80	R9 LPR	K947191LPR01VTE0
60x60	R9 LPR	K947086LPR01VTE0
30x60	R9 LPR	K947238LPR01VTE0



Vizon / Mink

60x120	R10A	K947469R0001VTE0
80x80	R10A	K947084R0001VTE0
40x80	R10A	K947189R0001VTE0
60x60	R10A	K947187R0001VTE0
30x60	R10A	K947236R0001VTE0
60x60	R11C	K947195R0001VTE0
30x60	R11C	K947241R0001VTE0
80x80	R9 LPR	K947084LPR01VTE0
40x80	R9 LPR	K947189LPR01VTE0
60x60	R9 LPR	K947187LPR01VTE0
30x60	R9 LPR	K947236LPR01VTE0



Koyu Grej / Dark Greige

60x120	R10A	K947467R0001VTE0
80x80	R10A	K947185R0001VTE0
40x80	R10A	K947193R0001VTE0
60x60	R10A	K947089R0001VTE0
30x60	R10A	K947239R0001VTE0
60x60	R11C	K947199R0001VTE0
30x60	R11C	K947244R0001VTE0
80x80	R9 LPR	K947185LPR01VTE0
40x80	R9 LPR	K947193LPR01VTE0
60x60	R9 LPR	K947089LPR01VTE0
30x60	R9 LPR	K947239LPR01VTE0

URBANCRETE



Beyaz / White	30x60	R10B	K947246R0001VTEO
Gri / Grey	30x60	R10B	K947249R0001VTEO
Koyu Gri / Dark Grey	30x60	R10B	K947252R0001VTEO
Vizon / Mink	30x60	R10B	K947255R0001VTEO
Koyu Grej / Dark Greige	30x60	R10B	K947258R0001VTEO

Tuğla Bordür - Brick Border
Koyu Gri / Dark Grey

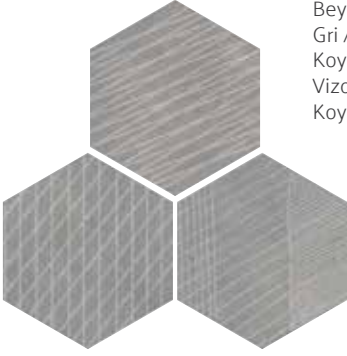

Beyaz / White	21x24	Mat/Matt	K94748900001VTEO
Gri / Grey	21x24	Mat/Matt	K94749000001VTEO
Koyu Gri / Dark Grey	21x24	Mat/Matt	K94749200001VTEO
Vizon / Mink	21x24	Mat/Matt	K94749300001VTEO
Koyu Grej / Dark Greige	21x24	Mat/Matt	K94749100001VTEO

Geometrik Altigen Dekor
Geometric Hexagon Decor
Koyu Gri / Dark Grey



21x24	Mat/Matt	K94711400001VTEO
-------	----------	------------------

Soğuk Altigen Dekor
Cold Hexagon Decor



Yeni
Novelty



21x24 Mat/Matt
K94744100001VTEO

Sıcak Altıgen Dekor
Warm Hexagon Decor



Beyaz / White	5x5	R10B	K947376R0001VTEO
Gri / Grey	5x5	R10B	K947378R0001VTEO
Koyu Gri / Dark Grey	5x5	R10B	K947380R0001VTEO
Vizon / Mink	5x5	R10B	K947382R0001VTEO
Koyu Grej / Dark Greige	5x5	R10B	K947384R0001VTEO

Kesme Bordür / Cut Border
Koyu Gri / Dark Grey



Süpürgelik / Plinth
Koyu Gri / Dark Grey

Beyaz / White	10x80	R10A	K947387R0001VTEO
Gri / Grey	10x80	R10A	K947385R0001VTEO
Koyu Gri / Dark Grey	10x80	R10A	K947388R0001VTEO
Vizon / Mink	10x80	R10A	K947386R0001VTEO
Koyu Grej / Dark Greige	10x80	R10A	K947389R0001VTEO

Beyaz / White	8,5x60	R10A	K947392R0001VTEO
Gri / Grey	8,5x60	R10A	K947390R0001VTEO
Koyu Gri / Dark Grey	8,5x60	R10A	K947393R0001VTEO
Vizon / Mink	8,5x60	R10A	K947391R0001VTEO
Koyu Grej / Dark Greige	8,5x60	R10A	K947394R0001VTEO



METALCRETE



PRO

NATURE

METALCRETE

Metali betonla yeniden yorumlayan porselen koleksiyonu. Metalcrete koleksiyonunda endüstriyel tasarımın temel malzemesi metal levhalar, büyük boyutu ve ışıltısıyla porselenin sakinliğine göz alıcı bir dokunuş katıyor. Koleksiyon siyah ve bronz renklerini modüler ebatlarla sunarak döşeme çeşitliliği sağlıyor.

A porcelain collection that reinterprets the fusion of metal and concrete. In the Metalcrete collection, the large size and shine of metal sheets – so basic to industrial design – add an attractive touch to the cool calm of porcelain. The collection offers iron and bronze colors in modular sizes to create a rich variety of tiling options and patterns.

Porselen Karolar / Porcelain Tiles

Bünye / Body Type

Colorbody Porselen / Colorbody Porcelain

Fon Ebatları / Basic Tile Sizes

80x80 cm (R 797x797 mm)

40x80 cm (R 397x797 mm)

Yüzey Alternatifleri / Surface Alternatives

LPR

Fon Renkleri / Basic Tile Colors

Bakır / Copper

Demir / Iron

Kullanım Alanları / Usage Areas

Konut / Residential

Ticari Alan / Commercial

Döşeme Alanları / Tiling Areas

Yer / Floor

Duvar / Wall

Dona Dayanım / Frost Resistance

Var / Available

Desen Farklılaşması / Shade Variation Classification

V2

Baskı Teknolojisi / Printing Technology

ReaLook

Ürün Standardı / Product Standard

EN14411 Group B1a

Dip Notlar / Footnotes

F H R



Porselen
Porcelain



Yer Karosu
Floor Tile



Duvar Karosu
Wall Tile



Modülerlik
Modularity



Konut
Residential



Ticari Alan
Commercial



Rektifiyeli
Rectified



Dona Dayanım
Frost Resistance



Desen Farklılaşması
Shade Variation



Yeni
Novelty



Lappato

METALCRETE

Porselen Karolar / Porcelain Tiles



80x80	LPR	K947533LPR01VTE0
40x80	LPR	K947537LPR01VTE0

Bakır / Copper



Yeni
Novelty



80x80	LPR	K947534LPR01VTE0
40x80	LPR	K947538LPR01VTE0

Demir / Iron



ULTRA 2.0

Yer Karoları / Floor Tiles : K908015R 30x60 Ultra Gümüş Gri / Silver Grey

Duvar Karoları / Wall Tiles : K908015R 30x60 Ultra Gümüş Gri / Silver Grey
K908026R 30x60 Ultra Antrasit / Anthracite



PRO

NATURE

ULTRA 2.0

Son yılların en çok tercih edilen çimento görünümlü taş dokusunu, parlak yansımalarla devam ettiren seramik serisi. Ultra 2.0, mekânlara ayrıcalıklı bir hava katıyor ve ışılı yüzey alternatifiyle modern şehir evlerine yepyeni bir soluk getiriyor.

A ceramic series adding bright reflections to the cement looking stone texture which is highly popular recently. Ultra 2.0 helps to create privileged spaces and blows a new life into modern urban residences with its glossy surface alternative.

Porselen Karolar / Porcelain Tiles

Bünye / Body Type

Colorbody Porselen / Colorbody Porcelain

Yüzey Alternatifleri / Surface Alternatives

R10A

R9 LPR

R9 Flat Mat / Matt

Fon Ebatları / Basic Tile Sizes

60x120 cm (R 592x1192 mm)

80x80 cm (R 797x797 mm)

60x60 cm (R 592x592 mm)

45x45 cm (R 442x442 mm)

30x60 cm (R 292x592 mm)

Fon Renkleri / Basic Tile Colors

Beyaz / White

Krem / Cream

Bej / Beige

Vizon / Mink

Moka / Mocha

Gümüş Gri / Silver Grey

Antrasit / Anthracite

Siyah / Black

Kullanım Alanları / Usage Areas

Konut / Residential

Ticari Alan / Commercial

Döşeme Alanları / Tiling Areas

Yer / Floor

Duvar / Wall

Dona Dayanım / Frost Resistance

Var / Available

Desen Farklılaşması /

Shade Variation Classification

V3

Baskı Teknolojisi / Printing Technology

RealLook

Ürün Standardı / Product Standard

EN14411 Group Bla

Dip Notlar / Footnotes

K R



Porselen
Porcelain



Yer Karosu
Floor Tile



Duvar Karosu
Wall Tile



Dış Cephe
Facade



Konut
Residential



Ticari Alan
Commercial



Dona Dayanım
Frost Resistance



Desen Farklılaşması
Shade Variation



Mat
Matt



Lappato



Rektifiyeli
Rectified



Ödüllü
Award Winning



ULTRA 2.0

Porselen Karolar / Porcelain Tiles



Beyaz / White

60x120	R10 A	K947638R0001VTE0
80x80	R10 A	K947694R0001VTE0
60x60	R10 A	K947654R0001VTE0
30x60	R10 A	K947614R0001VTE0
60x120	R9 FM	K947639R0001VTE0
80x80	R9 FM	K947695R0001VTE0
60x60	R9 FM	K947655R0001VTE0
30x60	R9 FM	K947615R0001VTE0
45x45	R9 FM	K94762800001VTE0
60x120	R9 LPR	K947638LPR01VTE0
80x80	R9 LPR	K947694LPR01VTE0
60x60	R9 LPR	K947654LPR01VTE0
30x60	R9 LPR	K947614LPR01VTE0



Krem / Cream

60x120	R10 A	K947642R0001VTE0
80x80	R10 A	K947698R0001VTE0
60x60	R10 A	K947658R0001VTE0
30x60	R10 A	K947618R0001VTE0
60x120	R9 FM	K947643R0001VTE0
80x80	R9 FM	K947699R0001VTE0
60x60	R9 FM	K947659R0001VTE0
30x60	R9 FM	K947619R0001VTE0
45x45	R9 FM	K94763000001VTE0
60x120	R9 LPR	K947642LPR01VTE0
80x80	R9 LPR	K947698LPR01VTE0
60x60	R9 LPR	K947658LPR01VTE0
30x60	R9 LPR	K947618LPR01VTE0



Bej / Beige

60x120	R10 A	K947636R0001VTE0
80x80	R10 A	K947692R0001VTE0
60x60	R10 A	K947652R0001VTE0
30x60	R10 A	K947612R0001VTE0
60x120	R9 FM	K947637R0001VTE0
80x80	R9 FM	K947693R0001VTE0
60x60	R9 FM	K947653R0001VTE0
30x60	R9 FM	K947613R0001VTE0
45x45	R9 FM	K94762700001VTE0
60x120	R9 LPR	K947636LPR01VTE0
80x80	R9 LPR	K947692LPR01VTE0
60x60	R9 LPR	K947652LPR01VTE0
30x60	R9 LPR	K947612LPR01VTE0



Vizon / Mink

60x120	R10 A	K947648R0001VTE0
80x80	R10 A	K947704R0001VTE0
60x60	R10 A	K947664R0001VTE0
30x60	R10 A	K947624R0001VTE0
60x120	R9 FM	K947649R0001VTE0
80x80	R9 FM	K947705R0001VTE0
60x60	R9 FM	K947665R0001VTE0
30x60	R9 FM	K947625R0001VTE0
45x45	R9 FM	K94763300001VTE0
60x120	R9 LPR	K947648LPR01VTE0
80x80	R9 LPR	K947704LPR01VTE0
60x60	R9 LPR	K947664LPR01VTE0
30x60	R9 LPR	K947624LPR01VTE0



Moka / Mocha

60x120	R10 A	K947644R0001VTE0
80x80	R10 A	K947700R0001VTE0
60x60	R10 A	K947660R0001VTE0
30x60	R10 A	K947620R0001VTE0
60x120	R9 FM	K947645R0001VTE0
80x80	R9 FM	K947701R0001VTE0
60x60	R9 FM	K947661R0001VTE0
30x60	R9 FM	K947621R0001VTE0
45x45	R9 FM	K94763100001VTE0
60x120	R9 LPR	K947644LPR01VTE0
80x80	R9 LPR	K947700LPR01VTE0
60x60	R9 LPR	K947660LPR01VTE0
30x60	R9 LPR	K947620LPR01VTE0



Gümüş Gri / Silver Grey

60x120	R10 A	K947640R0001VTE0
80x80	R10 A	K947696R0001VTE0
60x60	R10 A	K947656R0001VTE0
30x60	R10 A	K947616R0001VTE0
60x120	R9 FM	K947641R0001VTE0
80x80	R9 FM	K947697R0001VTE0
60x60	R9 FM	K947657R0001VTE0
30x60	R9 FM	K947617R0001VTE0
45x45	R9 FM	K94762900001VTE0
60x120	R9 LPR	K947640LPR01VTE0
80x80	R9 LPR	K947696LPR01VTE0
60x60	R9 LPR	K947656LPR01VTE0
30x60	R9 LPR	K947616LPR01VTE0



Antrasit / Anthracite

60x120	R10 A	K947634R0001VTE0
80x80	R10 A	K947690R0001VTE0
60x60	R10 A	K947650R0001VTE0
30x60	R10 A	K947610R0001VTE0
60x120	R9 FM	K947635R0001VTE0
80x80	R9 FM	K947691R0001VTE0
60x60	R9 FM	K947651R0001VTE0
30x60	R9 FM	K947611R0001VTE0
45x45	R9 FM	K94762600001VTE0
60x120	R9 LPR	K947634LPR01VTE0
80x80	R9 LPR	K947690LPR01VTE0
60x60	R9 LPR	K947650LPR01VTE0
30x60	R9 LPR	K947610LPR01VTE0



Siyah / Black

60x120	R10 A	K947646R0001VTE0
80x80	R10 A	K947702R0001VTE0
60x60	R10 A	K947662R0001VTE0
30x60	R10 A	K947622R0001VTE0
60x120	R9 FM	K947647R0001VTE0
80x80	R9 FM	K947703R0001VTE0
60x60	R9 FM	K947663R0001VTE0
30x60	R9 FM	K947623R0001VTE0
45x45	R9 FM	K94763200001VTE0
60x120	R9 LPR	K947646LPR01VTE0
80x80	R9 LPR	K947702LPR01VTE0
60x60	R9 LPR	K947662LPR01VTE0
30x60	R9 LPR	K947622LPR01VTE0

Ultra serisinin 8,5x45 ve 8,5x60 süpürgelik ebatları bulunmaktadır.
Ultra serie has 8,5x45 and 8,5x60 format plinths.



ASH&BURN

Duvar Porselen Karoları / Wall Porcelain Tiles :

K94607200001VTE0 7,5x30 Ash&Burn Kemik / Ash
K945690R0001VTE0 80x80 Ash&Burn Acı Kahve / Burn
K946241R0001VTE0 20x120 Aspenwood Koyu Grej / Greige

Yer Porselen Karoları / Floor Porcelain Tiles :

K945690R0001VTE0 80x80 Ash&Burn Acı Kahve / Burn
K94607300001VTE0 21x24 Ash&Burn Altigen / Hexagon Kemik / Ash
K94607600001VTE0 21x24 Ash&Burn Altigen / Hexagon Acı Kahve / Burn



PRO

NATURE

ASH&BURN

Sofistike renk tonları ve etkileyici dokusu ile endüstriyel beton görünümüne sınırsız bir yeni yorum kazandıran seramik serisi. Betonun zamansız sadeliğini doğanın sıcak tonlarıyla ısıtan koleksiyonda; altıgen karo seçenekleri, duvarda da kullanılabilen tuğla ebat ve küçük kare dekorlar yer alıyor.

A ceramic series which offers a warm new interpretation of industrial concrete look with sophisticated color tones and attractive textures. The collection warms the timeless simplicity of concrete with natural warm color shades, hexagonal tile options, brick sizes that can be used on the walls and small square decors.

Porselen Karolar / Porcelain Tiles

Bünye / Body Type

Colorbody Porselen / Colorbody Porcelain

Fon Ebatları / Basic Tile Sizes

80x80 cm (R 797x797 mm)

40x80 cm (R 397x797 mm)

60x60 cm (R 597x597 mm)

30x60 cm (R 297x597 mm)

10x80 cm (R 97x797 mm)

Sırlı porselen / Glazed Porcelain

Fon Ebatları / Basic Tile Sizes

7.5x30 cm (72x297mm)

15x15 cm (147x147mm)

21x24 cm Altıgen/Hexagon (210x241mm)

Yüzey Alternatifleri / Surface Alternatives

R9

Fon Renkleri / Basic Tile Colors

Kemik / Ash

Acı Kahve / Burn

Kullanım Alanları / Usage Areas

Konut / Residential

Ticari Alan / Commercial

Döşeme Alanları / Tiling Areas

Yer / Floor

Duvar / Wall

Dona Dayanım / Frost Resistance

Var / Available

Desen Farklılaşması / Shade Variation Classification

V4

Baskı Teknolojisi / Printing Technology

ReaLook

Ürün Standardı / Product Standard

EN14411 Group B1a

Dip Notlar / Footnotes

F H R



Porselen
Porcelain



Yer Karosu
Floor Tile



Duvar Karosu
Wall Tile



Dış Cephe
Facade



Dış Mekanlar
Outdoors



Konut
Residential



Ticari Alan
Commercial



Dona Dayanım
Frost Resistance



Desen Farklılaşması
Shade Variation



Mat
Matt



Rektifiyeli
Rectified



Rektifiyesiz
Non-Rectified



Küçük Ebat
Mini Size



Modülerlik
Modularity



Ödüllü
Award Winning



ASH&BURN

Porselen Karolar / Porcelain Tiles



80x80 R9 K945689R0001VTE0
40x80 R9 K945680R0001VTE0
10x80 R9 K946053R0001VTE0
60x60 R9 K945684R0001VTE0
30x60 R9 K945678R0001VTE0

Kemik / Ash



7.5x30 Mat/Matt K94607200001VTE0

Kemik / Ash

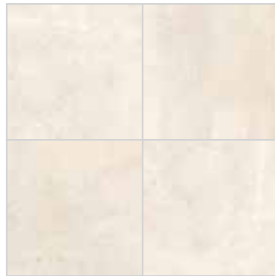

15x15 Mat/Matt
K94607400001VTE0

Kemik / Ash



15x15 Mat/Matt K94607800001VTE0

Dekor / Decor
Kemik / Ash



21x24 Mat/Matt
K94607300001VTE0

Altigen / Hexagon
Kemik / Ash



5x5 R10B K9463628R001VTE0

Kesme Mozaik Dekor / Cut Mosaic Decor
Kemik / Ash



8.5x60 R9 K945687R0001VTE0
10x80 R9 K945676R0001VTE0

Süpürgelik / Plinth
Kemik / Ash



80x80 R9 K945690R0001VTEO
40x80 R9 K945679R0001VTEO
10x80 R9 K946054R0001VTEO
60x60 R9 K945683R0001VTEO
30x60 R9 K945677R0001VTEO

Acı Kahve / Burn



7.5x30 Mat/Matt K94607500001VTEO

Acı Kahve / Burn

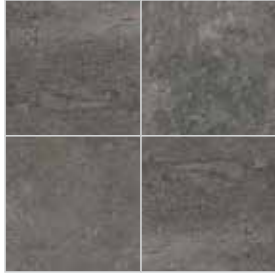

15x15 Mat/Matt
K94607700001VTEO

Acı Kahve / Burn

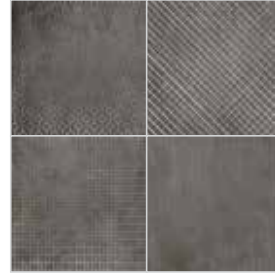

15x15 Mat/Matt K94607900001VTEO

Dekor / Decor
Acı Kahve / Burn



21x24 Mat/Matt
K94607600001VTEO

Altıgen / Hexagon
Acı Kahve / Burn



5x5 R10B K9463638R001VTEO

Kesme Mozaik Dekor / Cut Mosaic Decor
Acı Kahve / Burn



8.5x60 R9 K945688R0001VTEO
10x80 R9 K945675R0001VTEO

Süpürgelik / Plinth
Acı Kahve / Burn



Duvar Porselen Karoları / Wall Porcelain Tiles :

K945786R0001VTE0 60x60 Newcon Beyaz / White
K945754R0001VTE0 30x60 Newcon Beyaz / White

Yer Porselen Karoları / Floor Porcelain Tiles :

K945781R0001VTE0 60x60 Newcon Krem / Cream

NEWCON





Duvar Porselen Karoları / Wall Porcelain Tiles : K945772LPR01VTE0 60x120 Newcon Koyu Gri / Dark Grey

Yer Porselen Karoları / Floor Porcelain Tiles : K945785R0001VTE0 60x60 Newcon Gümüş Gri / Silver Grey

NEWCON





PRO

NATURE

NEWCON

Sakin yüzey dokusu ve doğal renk tonlarıyla şık ve fonksiyonel mekânlar yaratabilen beton görünümlü seramik serisi. Koleksiyon, birbiriyle uyumlu renk alternatifleri, modüler ebatları ve dış cephe için de kullanılabilir 60x120 porcelenleri ile konutlar ve ticari yapılar için bütünsel çözümler sunuyor.

A concrete textured ceramic series which creates stylish and functional spaces with its cool surface texture and natural color tones. The collection offers integrated solutions for residential and commercial buildings with compatible color alternatives, modular dimensions and 60x120 porcelain sizes for exterior cladding applications.

Porselen Karolar / Porcelain Tiles

Bünye / Body Type

Colorbody Porselen / Colorbody Porcelain

Yüzey Alternatifleri / Surface Alternatives

R10A

R9 LPR

R11B

Mat / Matt

Fon Ebatları / Basic Tile Sizes

60x120 cm (R 597x1197 mm)

80x80 cm (R 797x797 mm)

60x60 cm (R 597x597 mm)

30x60 cm (R 297x597 mm)

45x45 cm (447x447 mm)

30x30 cm (297x297 mm)

Dekor Ebatları / Decor Sizes

5x5 cm Kesme Dekor / Cut Decor

5x5 cm Mozaik Dekor / Mosaic Decor

30x60 Kesme Bordür / Cut Border

Fon Renkleri / Basic Tile Colors

Krem / Cream

Beyaz / White

Taupe / Taupe

Silver Gri / Silver Grey

Koyu Gri / Dark Grey

Antrasit / Anthracite

Kullanım Alanları / Usage Areas

Konut / Residential

Ticari Alan / Commercial

Döşeme Alanları / Tiling Areas

Yer / Floor

Duvar / Wall

Dona Dayanım / Frost Resistance

Var / Available

Desen Farklılaşması /

Shade Variation Classification

V3

Baskı Teknolojisi / Printing Technology

ReaLook

Ürün Standardı / Product Standard

EN14411 Group B1a

Dip Notlar / Footnotes

F H R S



Porselen
Porcelain



Yer Karosu
Floor Tile



Duvar Karosu
Wall Tile



Dış Cephe
Facade



Dış Mekanlar
Outdoors



Havuz Çevresi
Pool Surrounding



Konut
Residential



Ticari Alan
Commercial



Dona Dayanım
Frost Resistance



Desen Farklılaşması
Shade Variation



Mat
Matt



Lappato



R9 Lappato



Soft R10



Rektifiyeli
Rectified



Modülerlik
Modularity

NEWCON

Porselen Karolar / Porcelain Tiles



60x120	R10A	K945773R0001VTE0
80x80	R10A	K946177R0001VTE0
60x60	R10A	K945786R0001VTE0
30x60	R10A	K945754R0001VTE0
30x30	R10A	K94645600001VTE0
45x45	Mat/Matt	K94576500001VTE0
60x120	R9 LPR	K945773LPR01VTE0
80x80	R9 LPR	K946177LPR01VTE0
60x60	R9 LPR	K945786LPR01VTE0
30x60	R9 LPR	K945754LPR01VTE0
60x60	R11B	K945790R0001VTE0
30x60	R11B	K946171R0001VTE0

Beyaz / White



5x5 R10B K94633080001VTE0

Mozaik / Mosaic
Beyaz / White



5x5 R10B K9457718R001VTE0

5x5 R9 LPR K9457718LPR1VTE0

Kesme Mozaik Dekor / Cut Mosaic Decor
Beyaz / White



30x60 R10B K9464628R001VTE0

Kombibordür / Combiborder
Beyaz / White



30x120 R10A K946505R0001VTE0
30x60 R10A K946189R0001VTE0

Basamak / Step
Beyaz / White



10x80 R10A K946183R0001VTE0
8.5x60 R10A K945750R0001VTE0

Süpürgelik / Plinth
Beyaz / White

8.5x45 Mat K94579500001VTE0



60x120	R10A	K945775R0001VTE0
80x80	R10A	K946173R0001VTE0
60x60	R10A	K945781R0001VTE0
30x60	R10A	K945746R0001VTE0
30x30	R10A	K94645700001VTE0
45x45	Mat/Matt	K94576600001VTE0
60x120	R9 LPR	K945775LPR01VTE0
80x80	R9 LPR	K946173LPR01VTE0
60x60	R9 LPR	K945781LPR01VTE0
30x60	R9 LPR	K945746LPR01VTE0
60x60	R11B	K945782R0001VTE0
30x60	R11B	K946167R0001VTE0

Krem / Cream



5x5 R10B K94633380001VTE0

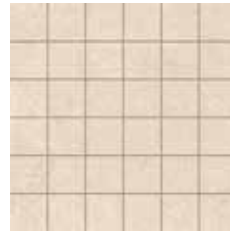

5x5 R10B K9457678R001VTE0
5x5 R9 LPR K9457678LPR1VTE0

Mozaik / Mosaic
Krem / Cream

Kesme Mozaik Dekor / Cut Mosaic Dekor
Krem / Cream



30x60 R10B K9464638R001VTE0

Kombibordür / Combi border
Krem / Cream



30x120 R10A K946501R0001VTE0
30x60 R10A K946185R0001VTE0

Basamak / Step
Krem / Cream



10x80 R10A K946179R0001VTE0
8.5x60 R10A K945749R0001VTE0

Süprügelik / Plinth
Krem / Cream

8.5x45 Mat K94579600001VTE0

NEWCON



60x120	R10A	K945778R0001VTE0
80x80	R10A	K946175R0001VTE0
60x60	R10A	K945785R0001VTE0
30x60	R10A	K945752R0001VTE0
30x30	R10A	K94645400001VTE0
45x45	Mat/Matt	K94576300001VTE0
60x120	R9 LPR	K945778LPR01VTE0
80x80	R9 LPR	K946175LPR01VTE0
60x60	R9 LPR	K945785LPR01VTE0
30x60	R9 LPR	K945752LPR01VTE0
60x60	R11B	K945789R0001VTE0
30x60	R11B	K946169R0001VTE0

Silver Gri / Silver Grey

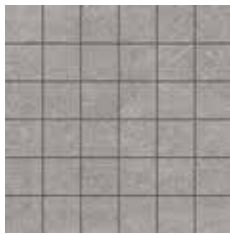

5x5 R10B K94633180001VTE0

Mozaik / Mosaic
Silver Gri / Silver Grey

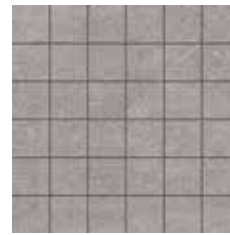

5x5 R10B K9457698R001VTE0
5x5 R9 LPR K9457698LPR1VTE0

Kesme Mozaik Dekor / Cut Mosaic Decor
Silver Gri / Silver Grey



30x60 R10B K9464608R001VTE0

Kombibordür / Combi border
Silver Gri / Silver Grey



30x120 R10A K946503R0001VTE0
30x60 R10A K946187R0001VTE0

Basamak / Step
Silver Gri / Silver Grey



10x80 R10A K946181R0001VTE0
8.5x60 R10A K945743R0001VTE0

Süpürgelik / Plinth
Silver Gri / Silver Grey

8.5x45 Mat K94579300001VTE0



60x120	R10A	K945774R0001VTE0
80x80	R10A	K946176R0001VTE0
60x60	R10A	K945784R0001VTE0
30x60	R10A	K945753R0001VTE0
30x30	R10A	K94645300001VTE0
45x45	Mat/Matt	K94576200001VTE0
60x120	R9 LPR	K945774LPR01VTE0
80x80	R9 LPR	K946176LPR01VTE0
60x60	R9 LPR	K945784LPR01VTE0
30x60	R9 LPR	K945753LPR01VTE0
60x60	R11B	K945788R0001VTE0
30x60	R11B	K946170R0001VTE0

Taupe / Taupe



5x5 R10B K94633280001VTE0

Mozaik / Mosaic
Taupe / Taupe



5x5 R10B K9457708R001VTE0
5x5 R9 LPR K9457708LPR1VTE0

Kesme Mozaik Dekor / Cut Mosaic Dekor
Taupe / Taupe

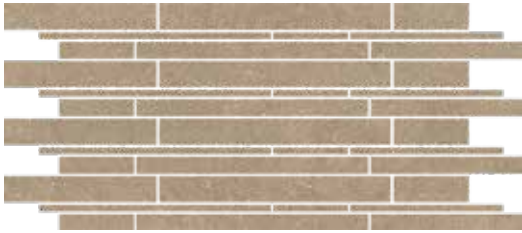

30x60 R10B K9464598R001VTE0

Kombibordür / Combiborder
Taupe / Taupe



30x120 R10A K946504R0001VTE0
30x60 R10A K946188R0001VTE0

Basamak / Step
Taupe / Taupe



10x80 R10A K946182R0001VTE0
8.5x60 R10A K945744R0001VTE0

Süpürgelik / Plinth
Taupe / Taupe

8.5x45 Mat K94579200001VTE0

NEWCON



60x120	R10A	K945772R0001VTE0
80x80	R10A	K946174R0001VTE0
60x60	R10A	K945783R0001VTE0
30x60	R10A	K945751R0001VTE0
30x30	R10A	K94645200001VTE0
45x45	Mat/Matt	K94576100001VTE0
60x120	R9 LPR	K945772LPR01VTE0
80x80	R9 LPR	K946174LPR01VTE0
60x60	R9 LPR	K945783LPR01VTE0
30x60	R9 LPR	K945751LPR01VTE0
60x60	R11B	K945787R0001VTE0
30x60	R11B	K946168R0001VTE0

Koyu Gri / Dark Grey

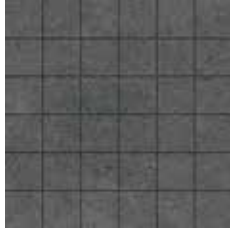

5x5 R10B K94632980001VTE0

Mozaik / Mosaic
Koyu Gri / Dark Grey

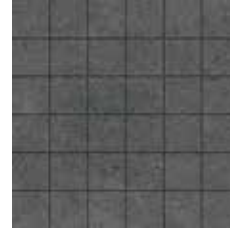

5x5 R10B K9457688R001VTE0
5x5 R9 LPR K9457688LPR1VTE0

Kesme Mozaik Dekor / Cut Mosaic Decor
Koyu Gri / Dark Grey

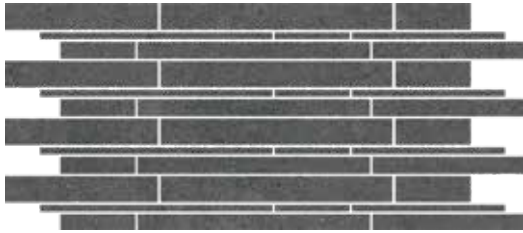

30x60 R10B K9464588R001VTE0

Kombibordür / Combiborder
Koyu Gri / Dark Grey

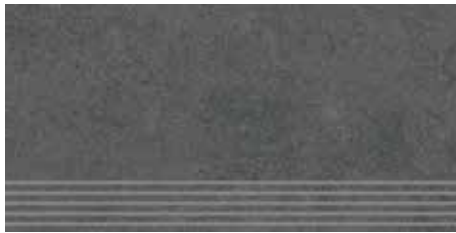

30x120 R10A K946502R0001VTE0
30x60 R10A K946186R0001VTE0

Basamak / Step
Koyu Gri / Dark Grey



10x80 R10A K946180R0001VTE0
8.5x60 R10A K945742R0001VTE0

Süpürgelik / Plinth
Koyu Gri / Dark Grey

8.5x45 Mat K94579100001VTE0



60x120	R10A	K945776R0001VTE0
80x80	R10A	K946172R0001VTE0
60x60	R10A	K945779R0001VTE0
30x60	R10A	K945745R0001VTE0
30x30	R10A	K94645500001VTE0
45x45	Mat/Matt	K94576400001VTE0
60x120	R9 LPR	K945776LPR01VTE0
80x80	R9 LPR	K946172LPR01VTE0
60x60	R9 LPR	K945779LPR01VTE0
30x60	R9 LPR	K945745LPR01VTE0
60x60	R11B	K945780R0001VTE0
30x60	R11B	K946166R0001VTE0

Antrasit / Anthracite



5x5 R10B K94633480001VTE0

Mozaik / Mosaic
Antrasit / Anthracite

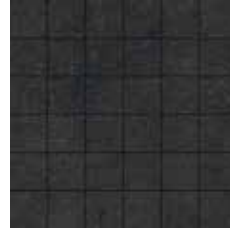

5x5 R10B K9457668R001VTE0
5x5 R9 LPR K9457668LPR1VTE0

Kesme Mozaik Dekor / Cut Mosaic Dekor
Antrasit / Anthracite

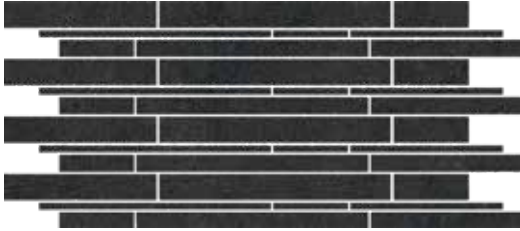

30x60 R10B K9464618R001VTE0

Kombibordür / Combiborder
Antrasit / Anthracite



30x120 R10A K946500R0001VTE0
30x60 R10A K946184R0001VTE0

Basamak / Step
Antrasit / Anthracite



10x80 R10A K946178R0001VTE0
8,5x60 R10A K945741R0001VTE0

Süprügelik / Plinth
Antrasit / Anthracite

8,5x45 Mat K94579400001VTE0



Duvar Porselen Karoları / Wall Porcelain Tiles : K946227R0001VTE0 60x60 Clay-Cement A. Gri / L. Cement
K946226R0001VTE0 30x60 Clay-Cement A. Gri / L. Cement Tuğla Kesme Dek. / Brick Cut Dec.
K945719R0001VTE0 60x60 Clay-Cement Gri / Cement

Yer Porselen Karoları / Floor Porcelain Tiles : K945719R0001VTE0 60x60 Clay-Cement Gri / Cement

CLAY-CEMENT





Duvar Porselen Karoları / Wall Porcelain Tiles :

K945708R0001VTE0 30x60 Clay-Cement Toprak / Dark Clay
K945720R0001VTE0 R9 60x60 60x60 Clay-Cement Toprak / Dark Clay
K945718R0001VTE0 60x60 Clay-Cement Taupe / Clay

Yer Porselen Karoları / Floor Porcelain Tiles :

K945718R0001VTE0 60x60 Clay-Cement Taupe / Clay

CLAY-CEMENT





PRO

NATURE

CLAY-CEMENT

Endüstriyel tasarım trendlerinin yeni gözdesi hibrit beton görünümlü seramik serisi. Betonun zamansız güzelliğini, kilin doğal sıcaklığıyla birleştiren koleksiyonda, modern renk tonları, modüler ebatlar ve rölyefli yüzey seçenekleri bulunuyor.

Ceramic series with hybrid concrete appearance is the new favorite of industrial design trends. The collection combines the timeless beauty of concrete with the natural warmth of clay, with modern color tones, modular dimensions and relief surface options.

Porselen Karolar / Porcelain Tiles

Bünye / Body Type

Colorbody Porselen / Colorbody Porcelain

Yüzey Alternatifleri / Surface Alternatives

R9

Fon Ebatları / Basic Tile Sizes

30x60 cm (R 297x597 mm)

60x60 cm (R 597x597 mm)

Dekor Ebatları / Decor Sizes

5x5 cm Kesme Dekor / Cut Decor

30x60 cm Tuğla Kesme Dekor/ Brick Cut Decor

30x60 cm Çubuk Kesme Dekor/ Stick Cut Decor

Fon Renkleri / Basic Tile Colors

Açık Gri / Light Cement

Gri / Cement

Fildişi / Light Clay

Taupe / Clay

Toprak / Dark Clay

Kullanım Alanları / Usage Areas

Konut / Residential

Ticari Alan / Commercial

Döşeme Alanları / Tiling Areas

Duvar / Wall

Yer / Floor

Dona Dayanım / Frost Resistance

Var / Available

Desen Farklılaşması / Shade Variation Classification

V4

Baskı Teknolojisi / Printing Technology

ReaLook

Ürün Standardı / Product Standard

EN14411 Group Bla

Dip Notlar / Footnotes

F H R



Porselen
Porcelain



Yer Karosu
Floor Tile



Duvar Karosu
Wall Tile



Dış Cephe
Facade



Dış Mekanlar
Outdoors



Konut
Residential



Ticari Alan
Commercial



Dona Dayanım
Frost Resistance



Desen Farklılaşması
Shade Variation



Mat
Matt



Rektifiyeli
Rectified



Modülerlik
Modularity

CLAY-CEMENT

Porselen Karolar / Porcelain Tiles



30x60 R9 K946226R0001VTE0
60x60 R9 K946227R0001VTE0

Açık Gri / Light Cement



30x60 R9 K9463768R001VTE0

Tuğla Kesme Dekor / Brick Cut Decor
Açık Gri / Light Cement



30x60 R9 K9463718R001VTE0

Çubuk Dekor / Stick Decor
Açık Gri / Light Cement



5x5 R10B K9463488R001VTE0

Kesme Dekor / Cut Decor
Açık Gri / Light Cement



8,5x60 R9 K946228R0001VTE0

Süpürgelik / Plinth
Açık Gri / Light Cement



30x60 R9 K945705R0001VTE0
60x60 R9 K945719R0001VTE0

Gri / Cement

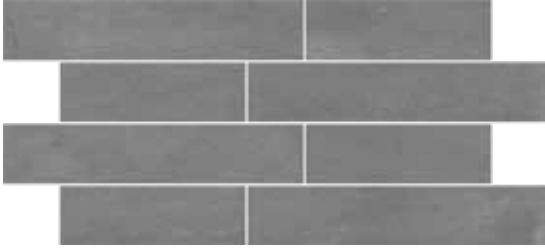

30x60 R9 K9463778R001VTE0

Tuğla Kesme Dekor / Brick Cut Decor
Gri / Cement

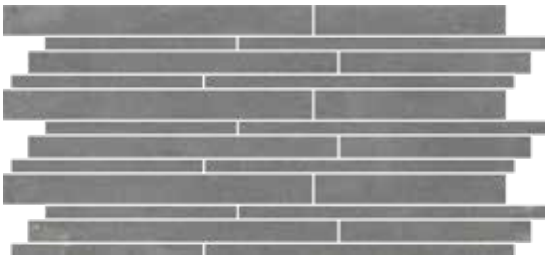

30x60 R9 K9463728R001VTE0

Çubuk Dekor / Stick Decor
Gri / Cement

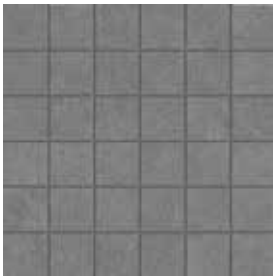

5x5 R10B K9463498R001VTE0

Kesme Dekor / Cut Decor
Gri / Cement



8.5x60 R9 K945727R0001VTE0

Süpürgelik / Plinth
Gri / Cement

CLAY-CEMENT

Porselen Karolar / Porcelain Tiles



30x60 R9 K945706R0001VTE0
60x60 R9 K945717R0001VTE0

Fildişi / Light Clay

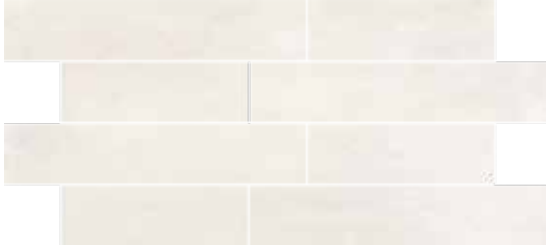

30x60 R9 K9463788R001VTE0

Tuğla Kesme Dekor / Brick Cut Decor
Fildişi / Light Clay



30x60 R9 K9463738R001VTE0

Çubuk Dekor / Stick Decor
Fildişi / Light Clay



5x5 R10B K9463508R001VTE0

Kesme Dekor / Cut Decor
Fildişi / Light Clay



8,5x60 R9 K945725R0001VTE0

Süpürgelik / Plinth
Fildişi / Light Clay



30x60 R9 K945707R0001VTE0
60x60 R9 K945718R0001VTE0

Taupe / Clay



30x60 R9 K9463798R001VTE0

Tuğla Kesme Dekor / Brick Cut Decor
Taupe / Clay



30x60 R9 K9463748R001VTE0

Çubuk Dekor / Stick Decor
Taupe / Clay



5x5 R10B K9463518R001VTE0

Kesme Dekor / Cut Decor
Taupe / Clay



8.5x60 R9 K945726R0001VTE0

Süpürgelik / Plinth
Taupe / Clay

CLAY-CEMENT

Porselen Karolar / Porcelain Tiles



30x60 R9 K945708R0001VTE0
60x60 R9 K945720R0001VTE0

Toprak / Dark Clay



30x60 R9 K9463808R001VTE0

Tuğla Kesme Dekor / Brick Cut Decor
Toprak / Dark Clay

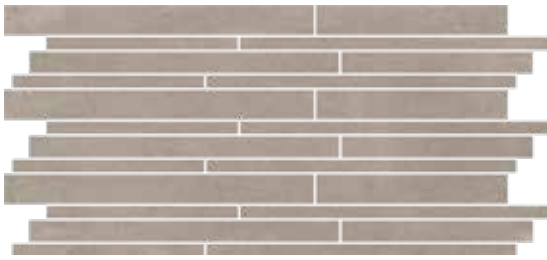

30x60 R9 K9463758R001VTE0

Çubuk Dekor / Stick Decor
Toprak / Dark Clay



5x5 R10B K9463528R001VTE0

Kesme Dekor / Cut Decor
Toprak / Dark Clay



8,5x60 R9 K945728R0001VTE0

Süpürgelik / Plinth
Toprak / Dark Clay





Duvar Porselen Karoları / Wall Porcelain Tiles : K94608200001VTE0 7.5X30 Bricx Tabac / Tabacco

Yer Porselen Karoları / Floor Porcelain Tiles : K945718R0001VTE0 60x60 Clay-Cement Taupe / Clay

BRICX





Duvar Porselen Karoları / Wall Porcelain Tiles : K94608300001VTE0 7,5x30 Bricx Gri / Grey

Yer Porselen Karoları / Floor Porcelain Tiles : K945719R0001VTE0 60x60 Clay-Cement Gri / Grey

BRICX





PRO

NATURE

BRICK

Mekânlarda doğallık ve sıcaklık yaratan tuğla görünümlü seramik serisi. Loft havasını ev içine taşıyan çizgisiyle modern tasarım trendlerinin yeni gündemini yansıtan koleksiyon, endüstriyel görünümü, doğallık sağlayan farklılaşmış renk tonları, sıvalı dokuları ve kalın derz aralıklı döşeme seçenekleriyle çağdaş mekânlar yaratıyor.

A brick-looking ceramic series that creates naturalness and warmth in spaces where it is used. The collection reflects the new agenda of modern design trends to residences, creating a contemporary loft atmosphere with its industrial appearance, distinctive natural color tones, plastered textures and brick-like tiling options.

Porselen Karolar / Porcelain Tiles

Bünye / Body Type

Sırlı Porselen / Glazed Porcelain

Yüzey Alternatifleri / Surface Alternatives

Mat / Matt

Fon Ebatları / Basic Tile Sizes

7.5x30 cm (72x297mm)

Fon Renkleri / Basic Tile Colors

Beyaz / White

Bej / Beige

Taba / Tobacco

Gri / Grey

Kullanım Alanları / Usage Areas

Konut / Residential

Döşeme Alanları / Tiling Areas

Yer / Floor

Duvar / Wall

Dona Dayanım / Frost Resistance

Var / Available

Desen Farklılaşması / Shade Variation Classification

V4

Baskı Teknolojisi / Printing Technology

ReaLook

Ürün Standardı / Product Standard

EN14411 Group Bla

Dip Notlar / Footnotes

F G H R



Porselen
Porcelain



Yer Karosu
Floor Tile



Duvar Karosu
Wall Tile



Konut
Residential



Dona Dayanım
Frost Resistance



Desen Farklılaşması
Shade Variation



Mat
Matt



Rektifiyesiz
Non-Rectified



Küçük Ebat
Mini Size

BRICX

Porselen Karolar / Porcelain Tiles



7.5x30 Mat/Matt K94608000001VTEo

Beyaz / White



7.5x30 Mat/Matt K94608300001VTEo

Gri / Grey



7.5x30 Mat/Matt K94608100001VTEo

Bej / Beige



7.5x30 Mat/Matt K94608200001VTEo

Taba / Tabacco







ICE & SMOKE



Yer Karoları / Floor Tiles : K937054R0001VTE0 80x80 Ice&Smoke Buz Gri / Ice Grey

Duvar Karoları / Wall Tiles : K937054R0001VTE0 80x80 Ice&Smoke Buz Gri / Ice Grey
K937076R0001VTE0 40x80 Ice&Smoke Buz Gri / Ice Grey
K937124R0001VTE0 40x80 Ice&Smoke Geometrik Mix Dekor / Geometric Mix Decor

PRO

NATURE

ICE & SMOKE

Temel yapı malzemelerinin baskın olarak kullanıldığı yeni bir seramik serisi. Seriyeye ismini veren buz ve duman renkleri, doğal görünümlü dokusu ve geometrik dekorlarıyla ferah bir mekân yaratmaya olanak sağlayan Ice & Smoke, yeni ebat alternatifleri de sunuyor.

A new ceramic series using basic construction materials predominantly. Named after ice and smoke hues, Ice & Smoke comes in new size options to create spaces with its natural outlook and geometrical decors.

Porselen Karolar / Porcelain Tiles

Bünye / Body Type

Colorbody Porselen / Colorbody Porcelain

Yüzey Alternatifleri / Surface Alternatives

R9

Fon Ebatları / Basic Tile Sizes

80x80 cm (R 797x797 mm)

60x60 cm (R 597x597 mm)

40x80 cm (R 397x797 mm)

10x80 cm (R 97x797 mm)

Dekor Ebatları / Decor Sizes

40x80 cm (R 397x797 mm)

Fon Renkleri / Basic Tile Colors

Buz Gri / Ice Grey

Duman Gri / Smoke Grey

Kullanım Alanları / Usage Areas

Konut / Residential

Ticari Alan / Commercial

Döşeme Alanları / Tiling Areas

Yer / Floor

Duvar / Wall

Dona Dayanım / Frost Resistance

Var / Available

Desen Farklılaşması / Shade Variation Classification

V4

Baskı Teknolojisi / Printing Technology

ReaLook

Ürün Standardı / Product Standard

EN14411 Group B1a

Dip Notlar / Footnotes

H R



Porselen
Porcelain



Yer Karosu
Floor Tile



Duvar Karosu
Wall Tile



Dış Cephe
Facade



Konut
Residential



Ticari Alan
Commercial



Dona Dayanım
Frost Resistance



Desen Farklılaşması
Shade Variation



Mat
Matt



Rektifiyeli
Rectified



Küçük Ebat
Mini Size



RektiPyesiz
Non Rectified

ICE & SMOKE

Porselen Karolar / Porcelain Tiles



80x80	R9	K937054R0001VTE0
40x80	R9	K937076R0001VTE0
10x80	R9	K937496R0001VTE0
60x60	R9	K937651R0001VTE0
15x15		K94698600001VTE0
7.5x30		K94698800001VTE0

Buz Gri / Ice Grey



80x80	R9	K937043R0001VTE0
40x80	R9	K937065R0001VTE0
10x80	R9	K937485R0001VTE0
60x60	R9	K937640R0001VTE0
15x15	Mat/Matt	K94698300001VTE0
7.5x30	Mat/Matt	K94698500001VTE0

Duman Gri / Smoke Grey



40x80 R9 K937124R0001VTEO

Geometrik Mix Dekor / Geometric Mix Dekor



10x80 R9 K943516R0001VTEO

Süpürgelik / Plinth
Buz Gri / Ice Grey



10x80 R9 K943520R0001VTEO

Süpürgelik / Plinth
Duman Gri / Smoke Grey



21x24 Mat/Matt
K94698700001VTEO

Buz Gri / Ice Grey



15x15 Mat/Matt
K94699000001VTEO

Buz Gri / Ice Grey
Dekor / Decor



21x24 Mat/Matt
K94698400001VTEO

Duman Gri / Smoke Grey

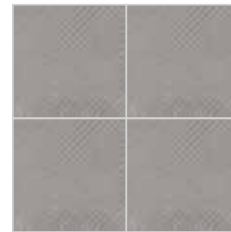

15x15 Mat/Matt
K94698900001VTEO

Duman Gri / Smoke Grey
Dekor / Decor



Yer Karoları / Floor Tiles : K935606FLPR1VTE0 60x60 Ice&Smoke Parlak / Glossy Buz Gri / Ice Grey

Duvar Karoları / Wall Tiles : K935621FLPR1VTE0 60x60 Ice&Smoke Parlak / Glossy Duman Gri / Smoke Grey

ICE & SMOKE
PARLAK / GLOSSY



PRO

NATURE

ICE & SMOKE PARLAK / GLOSSY

Temel yapı malzemelerinin baskın olarak kullanıldığı parlak yüzeyli seramik serisi. Ice & Smoke - Parlak, göz alıcı görünümü ve çarpıcı desenleriyle mekânlara prestij katıyor.

A porcelain tile series with glossy surface using basic construction materials predominantly. Ice & Smoke - Glossy adds prestige to spaces with its charmingly glossy outlook and attractive patterns.

Porselen Karolar / Porcelain Tiles

Bünye / Body Type

Sırlı Porselen / Glazed Porcelain

Yüzey Alternatifleri / Surface Alternatives

FLPR

Fon Ebatları / Basic Tile Sizes

60x60 cm (R 597x597 mm)

Fon Renkleri / Basic Tile Colors

Buz Gri / Ice

Duman Gri / Smoke

Kullanım Alanları / Usage Areas

Konut / Residential

Döşeme Alanları / Tiling Areas

Yer / Floor

Duvar / Wall

Dona Dayanım / Frost Resistance

Var / Available

Desen Farklılaşması /

Shade Variation Classification

V4

Baskı Teknolojisi / Printing Technology

RealLook

Ürün Standardı / Product Standard

EN14411 Group Bla

Dip Notlar / Footnotes

H R



Porselen
Porcelain



Yer Karosu
Floor Tile



Duvar Karosu
Wall Tile



Dış Cephe
Facade



Konut
Residential



Dona Dayanım
Frost Resistance



Desen Farklılaşması
Shade Variation



Full Lappato



Rektifiyeli
Rectified

ICE & SMOKE PARLAK / GLOSSY

Porselen Karolar / Porcelain Tiles



60x60

FLPR

K935606FLPR1VTEO

Buz Gri / Ice Grey



8,5x60

FLPR

K945153FLPR1VTEO

Süpürgelik / Plinth
Buz Gri / Ice Grey



60x60 FLPR K935621FLPR1VTE0

Duman Gri / Smoke Grey



8,5x60 FLPR K945152FLPR1VTE0

Süpürgelik / Plinth
Duman Gri / Smoke Grey



Yer Karoları / Floor Tiles : K94425600001VTE0 45x45 Ice&Smoke - S Buz Gri / Ice Grey

Duvar Karoları / Wall Tiles : K94494400001VTE0 25x40 Ice&Smoke - S Buz Gri / Ice Grey

K94494300001VTE0 25x40 Ice&Smoke - S Buz Gri Geometrik Dekor / Ice Grey Geometric Decor

ICE & SMOKE - S



PRO

NATURE

ICE & SMOKE - S

Ağırlıklı olarak temel yapı malzemelerinin kullanıldığı seramik serisi, adını sahip olduğu buz ve duman tonlarından alıyor. Doğal görünümü ve geometrik dekorlarıyla modern mekânlar yaratmak için ideal seri, şimdi yeni boyut seçenekleri de sunuyor.

A ceramic series using basic construction materials predominantly. Named after ice and smoke hues, Ice & Smoke comes in new size options to create spaces with its natural outlook and geometrical decors.

Duvar Karoları / Wall Tiles

Fon ve Dekor Ebatları / Basic Tile and Decor Sizes

25x40 cm
7,5x25 cm

Yüzey Alternatifleri / Surface Alternatives

Mat / Matt

Fon ve Dekor Renkleri / Basic Tile and Decor Colors

Buz Gri / Ice Grey
Duman Gri / Smoke Grey

Kullanım Alanları / Usage Areas

Konut / Residential
Ticari Alan / Commercial

Döşeme Alanları / Tiling Areas

Duvar / Wall

Desen Farklılaşması / Shade Variation Classification

V4

Dona Dayanım / Frost Resistance

Yok / Not Available

Baskı Teknolojisi / Printing Technology

ReaLook

Ürün Standardı / Product Standard

EN14411 Group BIII



Duvar Karosu
Wall Tile



Konut
Residential



Commercial



Mat
Matt



Rektifiyesiz
Non Rectified



Desen Farklılaşması
Shade Variation

Porselen Karolar / Porcelain Tiles

Bünye / Body Type

Sırlı Porselen / Glazed Porcelain

Yüzey Alternatifleri / Surface Alternatives

R9

Fon Ebatları / Basic Tile Sizes

45x45 cm (447x447 mm)

Fon Renkleri / Basic Tile Colors

Buz Gri / Ice Grey
Duman Gri / Smoke Grey

Kullanım Alanları / Usage Areas

Konut / Residential

Döşeme Alanları / Tiling Areas

Yer / Floor

Dona Dayanım / Frost Resistance

Var / Available

Desen Farklılaşması /

Shade Variation Classification

V4

Baskı Teknolojisi / Printing Technology

ReaLook

Ürün Standardı / Product Standard

EN14411 Group B1a (Glazed Porcelain)



Porselen
Porcelain



Yer Karosu
Floor Tile



Konut
Residential



Dona Dayanım
Frost Resistance



V4
Desen Farklılaşması
Shade Variation



Mat
Matt



Rektifiyesiz
Non Rectified

ICE & SMOKE - S

Duvar Karoları / Wall Tiles



25x40 Mat / Matt K94494400001VTE0

Buz Gri / Ice Grey



25x40 Mat / Matt K94494600001VTE0

Duman Gri / Smoke Grey



25x40 Mat / Matt K94494300001VTE0

Buz Gri / Ice Grey
Geometrik Dekor / Geometric Decor



25x40 Mat / Matt K94494500001VTE0

Duman Gri / Smoke Grey
Geometrik Dekor / Geometric Decor

ICE & SMOKE - S

Duvar Karoları / Wall Tiles



7,5x25 Mat / Matt K94545700001VTE0

Buz Gri / Ice Grey Bullnose



7,5x25 Mat / Matt K94545600001VTE0

Duman Gri / Smoke Grey Bullnose

Porselen Karolar / Porcelain Tiles



45x45 R9 K94425600001VTE0

Buz Gri / Ice Grey

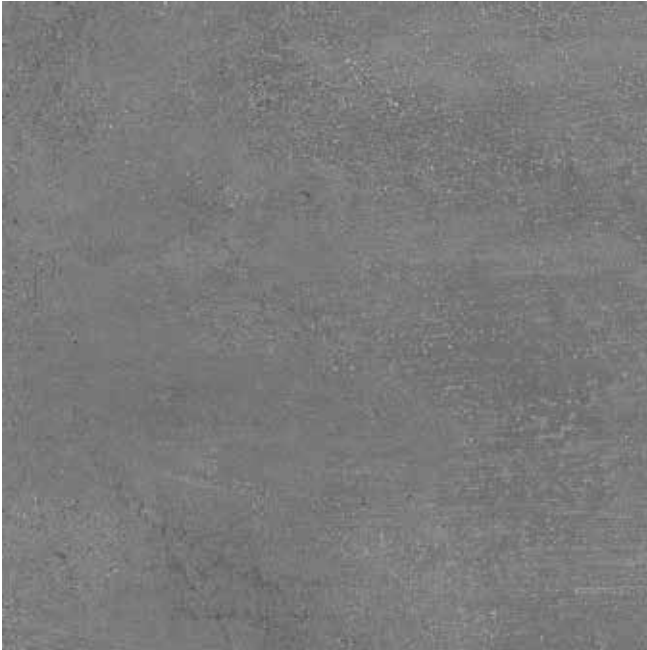

45x45 R9 K94425700001VTE0

Duman Gri / Smoke Grey



CEMENT-TECH



Yer Karoları / Floor Tiles : K943093R0001VTE0 80x80 Cement-Tech Antrasit / Anthracite

Duvar Karoları / Wall Tiles : K943091R0001VTE0 80x80 Cement-Tech Beyaz / White
K943092R0001VTE0 80x80 Cement-Tech Gri / Grey
K943093R0001VTE0 80x80 Cement-Tech Antrasit / Anthracite
K943094R0001VTE0 40x80 Cement-Tech Beyaz / White

PRO

NATURE

CEMENT-TECH

Endüstriyel yapıların modern ve minimal görüntüsünden esinlenen seramik serisi. Seri, şık loftlar ve ticari mekânlarda tercih edilen, günümüzün en moda mimari trendlerden olan “factory setting” uygulamasını yansıtıyor. Endüstriyel estetiği fonksiyonla bir araya getirirken orijinal görüntüsünü de koruyor. Cement-Tech, antrasit, gri ve beyazın doğal tonlarında sunuluyor.

A ceramic series inspired by the minimal industrial look of warehouse wall and floors. The series reflects the new fashionable architectural trend of “factory setting” which can be seen in luxury loft apartments as well as commercial spaces. It combines the advantages of industrial aesthetic with functional use without losing its original look in time. Its color alternatives are anthracite, grey and white in natural tones.

Porselen Karolar / Porcelain Tiles

Bünye / Body Type

Colorbody Porselen / Colorbody Porcelain

Yüzey Alternatifleri / Surface Alternatives

LPR

R9

Fon Ebatları / Basic Tile Sizes

80x80 cm (R 797x797 mm)

40x80 cm (R 397x797 mm)

60x60 cm (R 597x597 mm)

Fon Renkleri / Basic Tile Colors

Beyaz / White

Gri / Grey

Antrasit / Anthracite

Kullanım Alanları / Usage Areas

Konut / Residential

Ticari Alan / Commercial

Döşeme Alanları / Tiling Areas

Yer / Floor

Duvar / Wall

Dona Dayanım / Frost Resistance

Var / Available

Desen Farklılaşması / Shade Variation Classification

V4

Baskı Teknolojisi / Printing Technology

ReaLook

Ürün Standardı / Product Standard

EN14411 Group Bla

Dip Notlar / Footnotes

H R



Porselen
Porcelain



Yer Karosu
Floor Tile



Duvar Karosu
Wall Tile



Dış Cephe
Facade



Konut
Residential



Ticari Alan
Commercial



Dona Dayanım
Frost Resistance



Desen Farklılaşması
Shade Variation



Mat
Matt



Lappato



Rektifiyeli
Rectified



Ödüllü
Award Winning



reddot award 2016
winner



GOOD DESIGN
AWARD 2016

CEMENT-TECH

Porselen Karolar / Porcelain Tiles



Beyaz / White

80x80	R9	K943091R0001VTE0
40x80	R9	K943094R0001VTE0
60x60	R9	K943474R0001VTE0
80x80	LPR	K943091LPR01VTE0
40x80	LPR	K943094LPR01VTE0

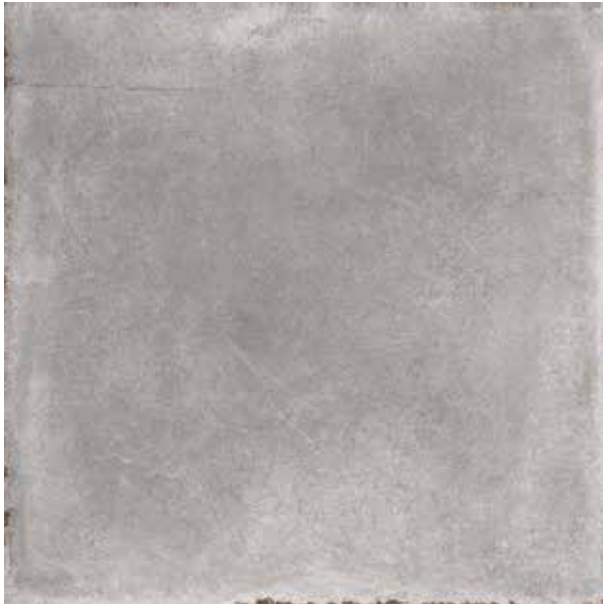

Gri / Grey

80x80	R9	K943092R0001VTE0
40x80	R9	K943095R0001VTE0
60x60	R9	K943475R0001VTE0
80x80	R10B	K944055R0001VTE0
80x80	LPR	K943092LPR01VTE0
40x80	LPR	K943095LPR01VTE0



80x80	R9	K943093R0001VTEO
40x80	R9	K943097R0001VTEO
60x60	R9	K943476R0001VTEO
80x80	LPR	K943093LPR01VTEO
40x80	LPR	K943097LPR01VTEO

Antrasit / Anthracite



Yer Karoları / Floor Tiles : K94555100001VTE0 45x45 Cement-Tech - S Gri / Grey

Duvar Karoları / Wall Tiles : K94538700001VTE0 25x40 Cement-Tech - S Gri / Grey

K94538600001VTE0 25x40 Cement-Tech - S Beyaz / White

K94538000001VTE0 25x40 Cement-Tech - S Beyaz Geometrik Dekor / White Geometric Decor

CEMENT-TECH - S



PRO

NATURE

CEMENT-TECH - S

Endüstriyel yapıların modern ve minimal görüntüsünden esinlenen seramik serisi. Seri, şık loftlar ve ticari mekânlarda tercih edilen günümüzün en moda mimari trendlerinden factory setting uygulamasını yansıtıyor. Endüstriyel estetiği fonksiyonla bir araya getirirken orijinal görüntüsünü de koruyor. Cement-Tech, antrasit, gri ve beyazın doğal tonlarında sunuluyor.

A ceramic series inspired by the minimal industrial look of warehouse wall and floors. The series reflects the new fashionable architectural trend of “factory setting” which can be seen in luxury loft apartments as well as commercial spaces. It combines the advantages of industrial aesthetic with functional use without losing its original look in time. Its color alternatives are anthracite, grey and white in natural tones.

Duvar Karoları / Wall Tiles

**Fon ve Dekor Ebatları /
Basic Tile and Decor Sizes**
25x40 cm (248x398 mm)

Yüzey Alternatifleri / Surface Alternatives
Mat / Matt

**Fon ve Dekor Renkleri /
Basic Tile and Decor Colors**
Beyaz / White
Gri / Grey
Antrasit / Anthracite

Kullanım Alanları / Usage Areas
Konut / Residential

Döşeme Alanları / Tiling Areas
Duvar / Wall

**Desen Farklılaşması / Shade Variation
Classification**
V4

Dona Dayanım / Frost Resistance
Yok / Not Available

Baskı Teknolojisi / Printing Technology
ReaLook

Ürün Standardı / Product Standard
EN14411 Group BIII



Duvar Karosu
Wall Tile



Konut
Residential



Desen Farklılaşması
Shade Variation



Mat
Matt



Rektifiyesiz
Non Rectified

Porselen Karolar / Porcelain Tiles

Bünye / Body Type

Sırlı Porselen / Glazed Porcelain

Yüzey Alternatifleri / Surface Alternatives

Mat / Matt

Fon Ebatları / Basic Tile Sizes

45x45 cm (447x447 mm)

Fon Renkleri / Basic Tile Colors

Beyaz / White

Gri / Grey

Antrasit / Anthracite

Kullanım Alanları / Usage Areas

Konut / Residential

Döşeme Alanları / Tiling Areas

Yer / Floor

Dona Dayanım / Frost Resistance

Var / Available

Desen Farklılaşması /

Shade Variation Classification

V4

Baskı Teknolojisi / Printing Technology

ReaLook

Ürün Standardı / Product Standard

EN14411 Group B1a



Porselen
Porcelain



Yer Karosu
Floor Tile



Konut
Residential



Dona Dayanım
Frost Resistance



V4
Desen Farklılaşması
Shade Variation



Mat
Matt



Rektifiyesiz
Non Rectified

CEMENT-TECH - S

Duvar Karoları / Wall Tiles



25x40 Mat / Matt K94538600001VTE0

Beyaz / White



25x40 Mat / Matt K94538000001VTE0

Beyaz / White
Geometrik Dekor / Geometric Decor



25x40 Mat / Matt K94538700001VTE0

Gri / Grey



25x40 Mat / Matt K94538100001VTE0

Gri / Grey
Geometrik Dekor / Geometric Decor



25x40 Mat / Matt K94538800001VTE0

Antrasit / Anthracite



25x40 Mat / Matt K94538200001VTE0

Antrasit / Anthracite
Geometrik Dekor / Geometric Decor

Porselen Karolar / Porcelain Tiles



45x45 R9 K94555000001VTE0

Beyaz / White



45x45 R9 K94555100001VTE0

Gri / Grey



45x45 R9 K94554900001VTE0

Antrasit / Anthracite



PICCADILLY



Yer Karoları / Floor Tiles : K922951R0001VTE0 45x90 Piccadilly Beyaz / White

Duvar Karoları / Wall Tiles : K922951R0001VTE0 45x90 Piccadilly Beyaz / White
K923113R0001VTE0 45x90 Piccadilly Çiçekli Dekor / Floral Decor Beyaz / White

PRO

NATURE

PICCADILLY

İsmi Londra'nın ünlü meydanından alan seramik serisi. Piccadilly, metal çerçeveye dökülen betonun sağlamlık ve katıksızlığını, yoğun gerçeklik hissiyle mekânlara yansıtıyor. Her tür çağdaş ortam için zarif ve ağırbaşlı bir görünüm yaratan seri, modern görünüme klasik bir dokunuş ekleyen çiçek motifi ve kesme bordür alternatifiyle yerlerde ve duvarlarda fark yaratıyor.

A ceramic series inspired by the famous square in London. Piccadilly reflects the soundness and purity of concrete poured in metal frame to spaces with an intense sense of reality. Offering a graceful and sober outlook to all contemporary spaces, the series makes a real difference in floors and walls with flower motives giving a classical touch to the modern outlook as well as crossing edge alternatives.

Porselen Karolar / Porcelain Tiles

Bünye / Body Type

Colorbody Porselen / Colorbody Porcelain

Yüzey Alternatifleri / Surface Alternatives

R9

LPR

Fon Ebatları / Basic Tile Sizes

45x90 cm (R 447x897 mm)

60x60 cm (R 597x597 mm)

30x60 cm (R 297x597 mm)

15x90 cm (R 147x897 mm)

Dekor Ebatları / Decor Sizes

45x90 cm (R 447x897 mm)

5x5 cm (Kesme Bordür / Cut Border)

Fon Renkleri / Basic Tile Colors

Beyaz / White

Gri / Gri

Kullanım Alanları / Usage Areas

Konut / Residential

Ticari Alan / Commercial

Döşeme Alanları / Tiling Areas

Yer / Floor

Duvar / Wall

Dona Dayanım / Frost Resistance

Var / Available

Desen Farklılaşması / Shade Variation Classification

V3

Baskı Teknolojisi / Printing Technology

ReaLook

Ürün Standardı / Product Standard

EN14411 Group Bla

Dip Notlar / Footnotes

H R I



Porselen
Porcelain



Yer Karosu
Floor Tile



Duvar Karosu
Wall Tile



Dış Cephe
Facade



Konut
Residential



Ticari Alan
Commercial



Dona Dayanım
Frost Resistance



Desen Farklılaşması
Shade Variation



Mat
Matt



Lappato



Rektifiyeli
Rectified

PICCADILLY

Porselen Karolar / Porcelain Tiles



Beyaz / White

45x90	R9	K922951R0001VTE0
60x60	R9	K922995R0001VTE0
30x60	R9	K923076R0001VTE0
15x90	R9	K939714R0001VTE0

45x90	LPR	K922951LPR01VTE0
60x60	LPR	K922995LPR01VTE0
30x60	LPR	K925762LPR01VTE0
15x90	LPR	K923076R0001VTE0



Gri / Grey

45x90	R9	K922962R0001VTE0
60x60	R9	K923006R0001VTE0
30x60	R9	K923080R0001VTE0
15x90	R9	K939703R0001VTE0

45x90	LPR	K922962LPR01VTE0
60x60	LPR	K923006LPR01VTE0
30x60	LPR	K925773LPR01VTE0



45x90
45x90

Beyaz / White
Beyaz / White

R9
LPR

K923113R0001VTE0
K923113LPR01VTE0

Dekor / Decor
Beyaz / White



45x90
45x90

Gri / Grey
Gri / Grey

R9
LPR

K923124R0001VTE0
K923124LPR01VTE0

Dekor / Decor
Gri / Grey

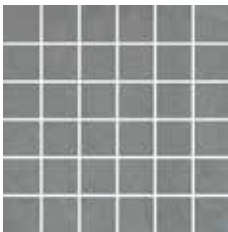

5x5
5x5

Beyaz / White
Gri / Grey

R10B
R10B

K084893R001VTE0
K0849048R001VTE0

Kesme Bordür / Cut Border
Beyaz / White



UPTOWN



Duvar Karoları / Wall Tiles : K916776R0001VTE0 22,5x90 Uptown Vizon / Mink
K916780R0001VTE0 22,5x90 Uptown Beyaz / White



PRO

NATURE

UPTOWN

Son yıllarda mimaride ve dekorasyonda çok popüler olan beton yüzeyleri, porselenin üstün nitelikleri ve dijital baskı teknolojisinin olanaklarıyla buluşturan seramik serisi.

Uptown, ödüllü bir tasarım olma özelliği taşıyor. Konutların yanı sıra, ticari yapılarda ve dış cephede de kullanılabilen seri, doğal renk alternatifleriyle sunuluyor.

A ceramic series combining concrete surfaces which have become highly popular in architecture and decoration lately with the superior qualities of porcelain and digital printing technology. Uptown is distinguished as an award winning design. The series presented in natural color options is ideal for commercial spaces and exterior facades in addition to residences.

Porselen Karolar / Porcelain Tiles

Bünye / Body Type

Colorbody Porselen / Colorbody Porcelain

Yüzey Alternatifleri / Surface Alternatives

Mat / Matt

LPR

Fon Ebatları / Basic Tile Sizes

45x90 cm (R 447x897 mm)

60x60 cm (R 597x597 mm)

22.5x90 cm (R 227x897 mm)

15x90 cm (R 147x897 mm)

30x60 cm (R 297x597 mm)

Fon Renkleri / Basic Tile Colors

Beyaz / White

Krem / Cream

Vizon / Mink

Koyu Gri / Dark Grey

Kullanım Alanları / Usage Areas

Konut / Residential

Ticari Alan / Commercial

Döşeme Alanları / Tiling Areas

Yer / Floor

Duvar / Wall

Dona Dayanım / Frost Resistance

Var / Available

Desen Farklılaşması / Shade Variation Classification

V3

Baskı Teknolojisi / Printing Technology

ReaLook

Ürün Standardı / Product Standard

EN14411 Group Bla

Dip Notlar / Footnotes

H R



Porselen
Porcelain



Yer Karosu
Floor Tile



Duvar Karosu
Wall Tile



Dış Cephe
Facade



Konut
Residential



Ticari Alan
Commercial



Dona Dayanım
Frost Resistance



Desen Farklılaşması
Shade Variation



Mat
Matt



Lappato



Rektifiyeli
Rectified



Ödüllü
Award Winning



2014



UPTOWN

Porselen Karolar / Porcelain Tiles



Beyaz / White

60x60	LPR	K914142LPR01VTE0
30x60	LPR	K914175LPR01VTE0
45x90	LPR	K914116LPR01VTE0
22.5x90	LPR	K916780LPR01VTE0
15x90	LPR	K916824LPR01VTE0
45x90	Mat / Matt	K914116R0001VTE0
60x60	Mat / Matt	K914142R0001VTE0
30x60	Mat / Matt	K914175R0001VTE0
22.5x90	Mat / Matt	K916780R0001VTE0
15x90	Mat / Matt	K916824R0001VTE0



Krem / Cream

60x60	LPR	K914120LPR01VTE0
30x60	LPR	K914153LPR01VTE0
45x90	LPR	K914094LPR01VTE0
22.5x90	LPR	K916765LPR01VTE0
15x90	LPR	K916802LPR01VTE0
45x90	Mat / Matt	K914094R0001VTE0
60x60	Mat / Matt	K914120R0001VTE0
30x60	Mat / Matt	K914153R0001VTE0
22.5x90	Mat / Matt	K916765R0001VTE0
15x90	Mat / Matt	K916802R0001VTE0



Vizon / Mink

60x60	LPR	K914131LPR01VTE0
30x60	LPR	K914164LPR01VTE0
45x90	LPR	K914105LPR01VTE0
22.5x90	LPR	K916776LPR01VTE0
15x90	LPR	K916813LPR01VTE0
45x90	Mat / Matt	K914105R0001VTE0
60x60	Mat / Matt	K914131R0001VTE0
30x60	Mat / Matt	K914164R0001VTE0
22.5x90	Mat / Matt	K916776R0001VTE0
15x90	Mat / Matt	K916813R0001VTE0



Koyu Gri / Dark Grey

60x60	LPR	K914805LPR01VTE0
30x60	LPR	K914816LPR01VTE0
45x90	LPR	K914794LPR01VTE0
22.5x90	LPR	K916791LPR01VTE0
15x90	LPR	K916835LPR01VTE0
60x60	Mat / Matt	K914805R0001VTE0
30x60	Mat / Matt	K914816R0001VTE0
45x90	Mat / Matt	K914794R0001VTE0
22.5x90	Mat / Matt	K916791R0001VTE0
15x90	Mat / Matt	K916835R0001VTE0



Yer Karoları / Floor Tiles : K943326R0001VTE0 30x60 Metro Bej / Beige

Duvar Karoları / Wall Tiles : K943326R0001VTE0 30x60 Metro Bej / Beige
K943328R0001VTE0 30x60 Metro Kahve / Brown

METRO



PRO

NATURE

METRO

Stil sahibi bir dinamizmle çarpıcı tasarımlar yaratma imkânı sunan seramik serisi. Ebat, renk ve yüzey zenginliğiyle Metro serisi, modern atmosferler tasarlamak için mükemmel bir seçim.

A ceramic series bringing a sense of tranquilly to spaces. The concrete texture Metro porcelain tiles offer a wide range of color, surface and size options to architects for the creation of modern buildings.

Porselen Karolar / Porcelain Tiles

Bünye / Body Type

Colorbody Porselen / Colorbody Porcelain

Yüzey Alternatifleri / Surface Alternatives

Mat / Matt

R10A

R11

LPR

Fon Ebatları / Basic Tile Sizes

45x90 cm (R 447x897 mm)

60x60 cm (R 597x597 mm)

60x60 cm (R 595x595 mm) 20 mm

30x60 cm (R 297x597 mm)

30x30 cm (297x297 mm)

45x45 cm (447x447 mm)

Dekor Ebatları

5x5 cm Kesme Dekor / Cut Decor

Fon Renkleri / Basic Tile Colors

Açık Gri / Light Grey

Gri / Grey

Bej / Beige

Açık Kahve / Schlamm

Kahve / Brown

Bazalt / Basalt

Antrasit / Anthracite

Kullanım Alanları / Usage Areas

Konut / Residential

Ticari Alan / Commercial

Döşeme Alanları / Tiling Areas

Yer / Floor

Duvar / Wall

Dona Dayanım / Frost Resistance

Var / Available

Desen Farklılaşması / Shade Variation Classification

V4

Baskı Teknolojisi / Printing Technology

RealLook

Ürün Standardı / Product Standard

EN14411 Group Bla

Dip Notlar / Footnotes

H R



Porselen
Porcelain



Yer Karosu
Floor Tile



Duvar Karosu
Wall Tile



Dış Cephe
Facade



Konut
Residential



Ticari Alan
Commercial



Havuz Çevresi
Pool Surrounding



Dona Dayanım
Frost Resistance



Desen Farklılaşması
Shade Variation



Mat
Matt



Lappato



Rektifiyeli
Rectified



20 mm Kalınlık
20 mm Thickness

Duvar Karoları / Wall Tiles

Fon ve Bordür Ebatları / Basic Tile and Border Sizes

33x100 cm (R 329x991 mm)
30x60 cm (R 297x597 mm)

Yüzey Alternatifleri / Surface Alternatives

Mat / Matt
Parlak / Glossy

Fon ve Dekor Renkleri / Basic Tile and Decor Colors

Beyaz / White
Krem / Cream
Gri / Grey

Kullanım Alanları / Usage Areas

Konut / Residential

Döşeme Alanları / Tiling Areas

Duvar / Wall

Dona Dayanım / Frost Resistance

Yok / Not Available

Baskı Teknolojisi / Printing Technology

ReaLook

Ürün Standardı / Product Standard

EN14411 Group BIII

Dip Notlar / Footnotes

H R



Yeni
Novelty



Duvar Karosu
Wall Tile



Konut
Residential



Ticari Alan
Commercial



Mat
Matt



Parlak
Glossy



Rektifiyeli
Rectified

METRO

Porselen Karolar / Porcelain Tiles



Bej / Beige

60x60	R11	K943791R0001VTE0	20 mm
30x60	R10A	K943326R0001VTE0	
60x60	R10A	K943309R0001VTE0	
45x90	R10A	K943316R0001VTE0	
30x30	R10A	K94376800001VTE0	
30x60	LPR	K943326LPR01VTE0	
60x60	LPR	K943309LPR01VTE0	
45x90	LPR	K943316LPR01VTE0	
45x45	Mat / Matt	K9443600001VTE0	



Açık Kahve / Schlamm

60x60	R11	K944036R0001VTE0	20 mm
30x60	R10A	K943327R0001VTE0	
60x60	R10A	K943311R0001VTE0	
45x90	R10A	K943317R0001VTE0	
30x30	R10A	K54168700001VTE0	
30x60	LPR	K943327LPR01VTE0	
60x60	LPR	K943311LPR01VTE0	
45x90	LPR	K943317LPR01VTE0	
45x45	Mat / Matt	K94436100001VTE0	



Kahve / Brown

60x60	R11	K944036R0001VTE0	20 mm
30x60	R10A	K943328R0001VTE0	
60x60	R10A	K943312R0001VTE0	
45x90	R10A	K943318R0001VTE0	
30x30	R10A	K54168900001VTE0	
30x60	LPR	K943328LPR01VTE0	
60x60	LPR	K943312LPR01VTE0	
45x90	LPR	K943318LPR01VTE0	
45x45	Mat / Matt	K94436200001VTE0	



Açık Gri / Light Grey

60x60	R11	K945307R0001VTE0	20 mm
30x60	R10A	K944406R0001VTE0	
60x60	R10A	K944414R0001VTE0	
45x90	R10A	K944689R0001VTE0	
30x30	R10A	K94468800001VTE0	
30x60	LPR	K944406LPR01VTE0	
60x60	LPR	K944414LPR01VTE0	
45x90	LPR	K944689LPR01VTE0	
45x45	Mat / Matt	K94456900001VTE0	



Gri / Grey

60x60 R11	K943859R0001VTE0	20 mm
30x60 R10A	K943304R0001VTE0	
60x60 R10A	K943305R0001VTE0	
45x90 R10A	K943313R0001VTE0	
30x30 R10A	K54169100001VTE0	
30x30 R10B	K94589500001VTE0	
30x60 LPR	K943304LPR01VTE0	
60x60 LPR	K943305LPR01VTE0	
45x90 LPR	K943313LPR01VTE0	
45x45 Mat / Matt	K94436300001VTE0	



Bazalt / Basalt

60x60 R11	K944035R0001VTE0	20 mm
30x60 R10A	K943325R0001VTE0	
60x60 R10A	K943307R0001VTE0	
45x90 R10A	K943314R0001VTE0	
30x30 R10A	K54168500001VTE0	
30x60 LPR	K943325LPR01VTE0	
60x60 LPR	K943307LPR01VTE0	
45x90 LPR	K943314LPR01VTE0	
45x45 Mat / Matt	K94435900001VTE0	



Antrasit / Anthracite

60x60 R11	K944035R0001VTE0	20 mm
30x60 R10A	K943324R0001VTE0	
60x60 R10A	K943308R0001VTE0	
45x90 R10A	K943315R0001VTE0	
30x30 R10A	K94376700001VTE0	
30x30 R10B	K94588300001VTE0	
30x60 LPR	K943324LPR01VTE0	
60x60 LPR	K943308LPR01VTE0	
45x90 LPR	K943315LPR01VTE0	
45x45 Mat / Matt	K94435800001VTE0	

METRO

Porselen Karolar / Porcelain Tiles



Kesme Dekor / Cut Decor
Gri / Grey

5x5	Açık Gri / Light Grey	R10B	K0862248R001VTE0
5x5	Gri / Grey	R10B	K0861748R001VTE0
5x5	Bej / Beige	R10B	K0861758R001VTE0
5x5	A.Kahve / Schlamm	R10B	K0861768R001VTE0
5x5	Kahve / Brown	R10B	K0861778R001VTE0
5x5	Bazalt / Basalt	R10B	K0861788R001VTE0
5x5	Antrasit / Anthracite	R10B	K0861738R001VTE0
5x5	Gri / Grey	R9 LPR	K0862258LPR1VTE0
5x5	Açık Gri / Light Grey	R9 LPR	K0862268LPR1VTE0
5x5	Bej / Beige	R9 LPR	K0862278LPR1VTE0
5x5	Bazalt / Basalt	R9 LPR	K0862288LPR1VTE0
5x5	Antrasit / Anthracite	R9 LPR	K0862298LPR1VTE0
5x5	A.Kahve / Schlamm	R9 LPR	K0862308LPR1VTE0
5x5	Kahve / Brown	R9 LPR	K0862318LPR1VTE0



Mix 1 Kesme Mozaik Dekor /
Mix 1 Cut Mosaic Decor

5x5 R10B K5416934R001VTE0

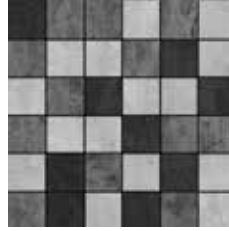

Mix 2 Mozaik Dekor /
Mix 2 Mosaic Decor

5x5 R10B K5416944R001VTE0



Kesme Bordür / Cut Border
Bej / Beige

1,5x15
K9463958R001VTE0

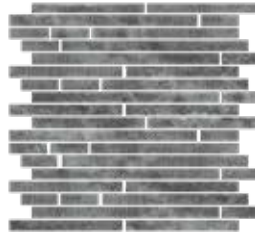

Kesme Bordür / Cut Border
Bazalt / Basalt

1,5x15
K9463938R001VTE0



Kesme Bordür / Cut Border
Gri / Grey

1,5x15
K9463948R001VTE0



Kesme Bordür / Cut Border
Antrasit / Anthracite

1,5x15
K9463928R001VTE0



Süpürgelik / Plinth
Açık Gri / Light Grey

8,5x60	Açık Gri / Light Grey	R10A	K945119R0001VTE0
8,5x60	Gri / Grey	R10A	K943896R0001VTE0
8,5x60	Bej / Beige	R10A	K943899R0001VTE0
8,5x60	A.Kahve / Schlamm	R10A	K943900R0001VTE0
8,5x60	Kahve / Brown	R10A	K943901R0001VTE0
8,5x60	Bazalt / Basalt	R10A	K943897R0001VTE0
8,5x60	Antrasit / Anthracite	R10A	K943898R0001VTE0

Duvar Karoları / Wall Tiles



33x100 Mat / Matt
33x100 Parlak / Glossy

K946275R0001VTS0
K946291PR001VTS0

Beyaz / White



33x100 Mat / Matt
33x100 Parlak / Glossy

K946290PR001VTS0
K946276PR001VTS0

Krem / Cream



33x100 Mat / Matt
33x100 Parlak / Glossy

K946276R0001VTS0
K946276PR001VTS0

Gri / Grey

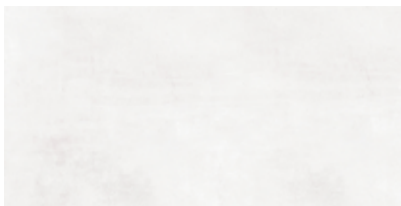

30x60 Mat / Matt
30x60 Parlak / Glossy

K945145R0001VTE0
K945155PR001VTE0

Beyaz / White



30x60 Mat / Matt
30x60 Parlak / Glossy

K945123R0001VTE0
K945155PR001VTE0

Krem / Cream

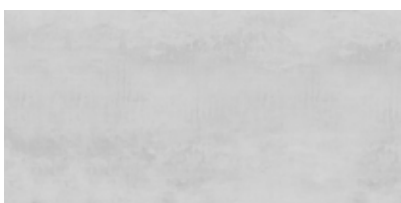

30x60 Mat / Matt
30x60 Parlak / Glossy

K945124R0001VTE0
K945154PR001VTE0

Gri / Grey



Yer Karoları / Floor Tiles : K90164300001VTE0 45x45 Vado Gri / Grey

Duvar Karoları / Wall Tiles : K90141100001VTE0 30x60 Vado Gri / Grey
K90153600001VTE0 30x60 Vado Beyaz / White
K901584R0001VTE0 60x60 Vado Gri / Grey
K53944680001VTE0 M5x5 Vado Beyaz / White

VADO



Porselen Karolar / Porcelain Tiles

Bünye / Body Type

Sırlı Porselen / Glazed Porcelain
Seramik Yer Karosu / Ceramic Floor Tiles

Yüzey Alternatifleri / Surface Alternatives

Mat / Matt
R10B

Fon Ebatları / Basic Tile Sizes

60x60 (R 597x597 mm)
30x60 (297x597 mm)
30x60 (297x597 mm)
45x45 (447x447 mm)
30x30 (297x297 mm)
33x33 (328,5x328,5 mm)

Dekor Ebatları / Decor Tile Sizes

5x5 cm

Fon Renkleri / Basic Tile Colors

Beyaz / White
Bej / Beige
Soft Kahve / Soft Brown
Moka / Mocha
Gri / Grey
Antrasit / Anthracite

Kullanım Alanları / Usage Areas

Konut / Residential

Döşeme Alanları / Tiling Areas

Yer / Floor
Duvar / Wall

Dona Dayanım / Frost Resistance

Var / Available

Desen Farklılaşması / Shade Variation Classification

V1

Ürün Standardı / Product Standard

EN14411 Group Bla
EN14411 Group Blb

Dip Notlar / Footnotes

H R I

PRO

NATURE

VADO

Yaşam alanları ve konutlar için en pratik şekilde sadeliği şıklıkla bir araya getiren seramik serisi. Basit bir dokunuşla evlerde ferah ve görkemli mekânlar yaratmaya imkân sağlıyor. Zengin ebat çeşitliliği ve renk paletiyle tüm ihtiyaçlara ve beğenilere hizmet ediyor.

A ceramic series makes it possible to create elegant and magnificent residential spaces. It appeals to all tastes thanks to its rich color palette and size alternatives.



Porselen
Porcelain



Yer Karosu
Floor Tile



Duvar Karosu
Wall Tile



Dış Cephe
Facade



Konut
Residential



Dona Dayanım
Frost Resistance



Desen Farklılaşması
Shade Variation



Mat
Matt



Rektifiyeli
Rectified



Rektifiyesiz
Non-Rectified

VADO

Porselen Karolar / Porcelain Tiles



Beyaz / White

60x60	Mat / Matt	K901595R0001VTE0
45x45	Mat / Matt	K90165400001VTE0
30x60	Mat / Matt	K90153600001VTE0
30x60	Mat / Matt	K901536R0001VTE0
30x30	Mat / Matt	K90455200001VTE0
45x45	R10B	K94315300001VTE0



Bej / Beige

60x60	Mat / Matt	K901621R0001VTE0
45x45	Mat / Matt	K90168000001VTE0
30x60	Mat / Matt	K90142200001VTE0
30x60	Mat / Matt	K901422R0001VTE0
30x30	Mat / Matt	K90457400001VTE0
45x45	R10B	K94332000001VTE0



Soft Kahve / Soft Brown

60x60	Mat / Matt	K901610R0001VTE0
45x45	Mat / Matt	K90167600001VTE0
30x60	Mat / Matt	K90155100001VTE0
30x60	Mat / Matt	K901551R0001VTE0
30x30	Mat / Matt	K90456300001VTE0
45x45	R10B	K93742600001VTE0

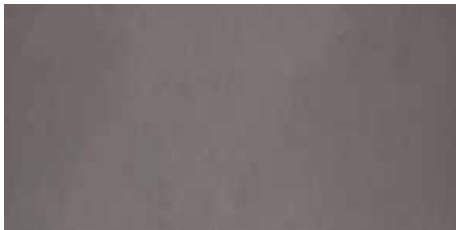

Gri / Grey

60x60	Mat / Matt	K901584R0001VTE0
45x45	Mat / Matt	K90164300001VTE0
30x60	Mat / Matt	K90141100001VTE0
30x60	Mat / Matt	K901411R0001VTE0
30x30	Mat / Matt	K90454100001VTE0
45x45	R10B	K94331900001VTE0

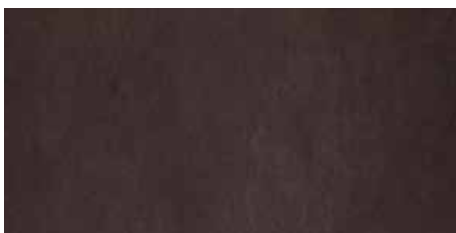

Moka / Mocha

60x60	Mat / Matt	K901606R0001VTE0
45x45	Mat / Matt	K90166500001VTE0
30x60	Mat / Matt	K90154000001VTE0
30x60	Mat / Matt	K901540R0001VTE0
30x30	Mat / Matt	K90458500001VTE0
45x45	R10B	K94332300001VTE0

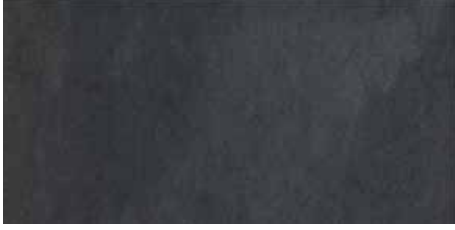

60x60	Mat / Matt	K901573R0001VTE0
45x45	Mat / Matt	K90163200001VTE0
30x60	Mat / Matt	K90147000001VTE0
30x60	Mat / Matt	K901470R0001VTE0
30x30	Mat / Matt	K90459600001VTE0
45x45	R10B	K94332200001VTE0

Antrasit / Anthracite



5x5 Beyaz / White	K53944680001VTE0
5x5 Bej / Beige	K53946180001VTE0
5x5 Soft Kahve / Soft Brown	K53945080001VTE0
5x5 Gri / Grey	K53943580001VTE0
5x5 Moka / Mocha	K53947280001VTE0
5x5 Antrasit / Anthracite	K53948380001VTE0

Kalıptan Bordür / Pressed Border
Beyaz / White



45x45	Mat / Matt	Beyaz / White	K90183100001VTE0
45x45	Mat / Matt	Bej / Beige	K90186400001VTE0
45x45	Mat / Matt	Gri / Grey	K90182000001VTE0
45x45	Mat / Matt	Antrasit / Anthracite	K90181600001VTE0
45x45	Mat / Matt	Moka / Mocha	K90184200001VTE0
45x45	Mat / Matt	Soft Kahve / Soft Brown	K90185300001VTE0

Basamak / Stair
Beyaz / White



Süpürgelik / Plinth
Beyaz / White

7x30	Mat / Matt	Beyaz / White	K91927400001VTE0
		Bej / Beige	K91751300001VTE0
		Soft Kahve / Soft Brown	K91928500001VTE0
		Moka / Mocha	K91929600001VTE0
		Gri / Grey	K91926300001VTE0
		Antrasit / Anthracite	K91930000001VTE0

8,5x45	Mat / Matt	Beyaz / White	K90177200001VTE0
		Bej / Beige	K90180500001VTE0
		Soft Kahve / Soft Brown	K90179400001VTE0
		Moka / Mocha	K90178300001VTE0
		Gri / Grey	K90176100001VTE0
		Antrasit / Anthracite	K90175000001VTE0

8,5x60	Mat / Matt	Beyaz / White	K90171300001VTE0
		Bej / Beige	K90174600001VTE0
		Soft Kahve / Soft Brown	K90173500001VTE0
		Moka / Mocha	K90172400001VTE0
		Gri / Grey	K90170200001VTE0
		Antrasit / Anthracite	K90169100001VTE0

VADO

Seramik Yer Karosu / Ceramic Floor Tiles



33x33 Mat / Matt K91852600001VTE0

Beyaz / White



33x33 Mat / Matt K91854100001VTE0

Bej / Beige



33x33 Mat / Matt K91853000001VTE0

Soft Kahve / Soft Brown



33x33 Mat / Matt K91851500001VTE0

Gri / Grey



33x33 Mat / Matt K91855200001VTE0

Moka / Mocha



33x33 Mat / Matt K91856300001VTE0

Antrasit / Anthracite



Süpürgelik / Plinth
Antrasit / Anthracite

8x33 Mat / Matt

Beyaz / White

K91858500001VTE0

Bej / Beige

K91860000001VTE0

Soft Kahve / Soft Brown

K91859600001VTE0

Moka / Mocha

K91861100001VTE0

Gri / Grey

K91857400001VTE0

Antrasit / Anthracite

K91862200001VTE0



ESSENCE



Yer Karoları / Floor Tiles : K944473R0001VTEO 60x60 Essence Koyu Gri / Dark Grey

Duvar Karoları / Wall Tiles : K944452R0001VTEO 30x60 Essence Krem / Cream
K944461R0001VTEO 30x60 Essence Koyu Gri / Dark Grey

PRO

NATURE

ESSENCE

Beton görünümüyle, ticari yapılar yanında konutlar için de modası hiç geçmeyecek yalın tasarımlara olanak sağlayan seramik serisi. Double charge bünyesinin kazandırdığı ekstra aşınma dayanıklılığı sayesinde Essence yoğun trafiği olan zeminlerde ve dış cephe uygulamalarında güvenle tercih edilebilir. Parlak ve mat yüzey seçenekleri yanında sunulan R12 kaymazlık alternatifi, ıslak alanlar ve havuz çevresinde kullanıma uygundur.

A concrete textured ceramic series allowing lean designs for both commercial and residential buildings. Thanks to extra wear resistance of its double charge body, essence can be safely used on floorings with heavy traffic and exterior cladding applications. Besides the glossy and matte surface options, the R12 non-slip alternative is suitable for use in wet areas and around pools.

Porselen Karolar / Porcelain Tiles

Bünye / Body Type

Double Charge

Yüzey Alternatifleri / Surface Alternatives

R9

R12C

Parlak / Polished

Fon Ebatları / Basic Tile Sizes

60x60 cm (R 597x597 mm)

30x60 cm (R 297x597 mm)

Fon Renkleri / Basic Tile Colors

Beyaz / White

Krem / Cream

Moka / Mocha

Açık Gri / Light Grey

Koyu Gri / Dark Grey

Antrasit / Anthracite

Kullanım Alanları / Usage Areas

Konut / Residential

Ticari Alan / Commercial

Döşeme Alanları / Tiling Areas

Yer / Floor

Duvar / Wall

Dona Dayanım / Frost Resistance

Var / Available

Desen Farklılaşması / Shade Variation Classification

V2

Baskı Teknolojisi / Printing Technology

ReaLook

Ürün Standardı / Product Standard

EN14411 Group Bla

Dip Notlar / Footnotes

H R



Porselen
Porcelain



Yer Karosu
Floor Tile



Duvar Karosu
Wall Tile



Dış Cephe
Facade



Konut
Residential



Ticari Alan
Commercial



Havuz Çevresi
Pool Surrounding



Dona Dayanım
Frost Resistance



Mat
Matt



Parlak
Glossy



Desen Farklılaşması
Shade Variation



Rektifiyeli
Rectified

ESSENCE

Porselen Karolar / Porcelain Tiles



Beyaz / White

60x60	R10	K945855R0001VTE0
30x60	R10	K945850R0001VTE0
60x60	R12C	K945859R0001VTE0
30x60	R12C	K945856R0001VTE0
30x30	R12C	K945866R0001VTE0
60x60	Parlak / Polished	K945162PR001VTE0
30x60	Parlak / Polished	K945163PR001VTE0



Krem / Cream

60x60	R10	K944464R0001VTE0
30x60	R10	K944452R0001VTE0
60x60	R12C	K944463R0001VTE0
30x60	R12C	K944451R0001VTE0
30x30	R12C	K945863R0001VTE0
60x60	Parlak / Polished	K945233PR001VTE0
30x60	Parlak / Polished	K945230PR001VTE0



Moka / Mocha

60x60	R10	K945854R0001VTE0
30x60	R10	K945851R0001VTE0
60x60	R12C	K945860R0001VTE0
30x60	R12C	K945857R0001VTE0
30x30	R12C	K945867R0001VTE0
60x60	Parlak / Polished	K945161PR001VTE0
30x60	Parlak / Polished	K945164PR001VTE0



60x60	R10	K944470R0001VTE0
30x60	R10	K944458R0001VTE0
60x60	R12C	K944469R0001VTE0
30x60	R12C	K944457R0001VTE0
30x30	R12C	K945864R0001VTE0
60x60	Parlak / Polished	K945231PR001VTE0
30x60	Parlak / Polished	K945228PR001VTE0

Açık Gri / Light Grey



60x60	R10	K944473R0001VTE0
30x60	R10	K944461R0001VTE0
60x60	R12C	K944472R0001VTE0
30x60	R12C	K944460R0001VTE0
30x30	R12C	K945865R0001VTE0
60x60	Parlak / Polished	K945232PR001VTE0
30x60	Parlak / Polished	K945229PR001VTE0

Koyu Gri / Dark Grey



60x60	R10	K945853R0001VTE0
30x60	R10	K945852R0001VTE0
60x60	R12C	K945861R0001VTE0
30x60	R12C	K945858R0001VTE0
30x30	R12C	K945868R0001VTE0
60x60	Parlak / Polished	K945849PR001VTE0
30x60	Parlak / Polished	K945848PR001VTE0

Antrasit - Anthracite

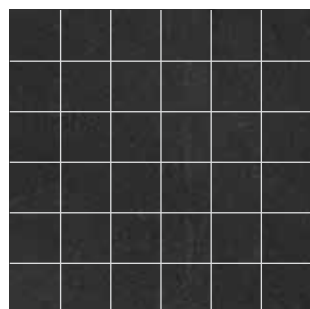

Kesme Mozaik / Cut Mosaic
Antrasit - Anthracite

Beyaz - White	5x5	R12C	K9459988R001VTE0
	5x5	R10	K9460068R001VTE0
Krem / Cream	5x5	R12C	K9459998R001VTE0
	5x5	R10	K9460078R001VTE0
Moka - Mocha	5x5	R12C	K9460058R001VTE0
	5x5	R10	K9460118R001VTE0
Açık Gri / Light Grey	5x5	R12C	K9460008R001VTE0
	5x5	R10	K9460088R001VTE0
Koyu Gri / Dark Grey	5x5	R12C	K9460038R001VTE0
	5x5	R10	K9460098R001VTE0
Antrasit - Anthracite	5x5	R12C	K9460048R001VTE0
	5x5	R10	K9460108R001VTE0



MICROTEC



Yer Karoları / Floor Tiles :

K864480R0001VTE0 Microtec 60x60 Antrasit / Anthracite Mat / Matt
K86478200001VTE0 Microtec 60x60 Antrasit / Anthracite Parlak / Glossy

PRO

NATURE

MICROTEC

Doğala en yakın görünümü elde etmek için ileri porselen teknolojisini kullanan seramik serisi. Yeni nesil tasarım anlayışı ile mekânlara endüstriyel bir atmosfer katıyor. Sırsız üretilen karolar üzerine presleme tekniği ile verilen efektler alışılmışın dışında yüzey dokuları oluşturuyor. Renk alternatifleri ve farklı yüzey seçenekleriyle yerlerde ve duvarlarda benzersiz bir ambiyans yaratıyor.

Using advanced porcelain technology to acquire a natural outlook, microtec series adds industrial touch to new generation design philosophy. Effects imprinted on unglazed tiles with a pressing technique create unconventional textures. The series comes in different color options in addition to surface alternatives to create a perfect ambiance in floors and walls.

Porselen Karolar / Porcelain Tiles

Bünye / Body Type

Double Charge

Yüzey Alternatifleri / Surface Alternatives

Mat / Matt

Parlak / Polished

Fon Ebatları / Basic Tile Sizes

60x60 cm (R 597x597 cm)

30x60 cm (R 297x597 cm)

Fon Renkleri / Basic Tile Colors

Beyaz / White

Açık Krem / Light Cream

Moka / Mocha

Açık Gri / Light Grey

Gri / Grey

Antrasit / Anthracite

Kullanım Alanları / Usage Areas

Konut / Residential

Ticari Alan / Commercial

Döşeme Alanları / Tiling Areas

Yer / Floor

Duvar / Wall

Dona Dayanım / Frost Resistance

Var / Available

Desen Farklılaşması / Shade Variation Classification

V3

Baskı Teknolojisi / Printing Technology

ReaLook

Ürün Standardı / Product Standard

EN14411 Group B1a

Dip Notlar / Footnotes

H P R



Porselen
Porcelain



Yer Karosu
Floor Tile



Duvar Karosu
Wall Tile



Konut
Residential



Ticari Alan
Commercial



Dona Dayanım
Frost Resistance



Desen Farklılaşması
Shade Variation



Mat
Matt



Parlak
Glossy

MICROTEC

Porselen Karolar / Porcelain Tiles



Beyaz / White

60x60	Mat / Matt	K864771R0001VTEO
60x60	Parlak / Polished	K86481500001VTEO
30x60	Mat / Matt	K864723R0001VTEO
30x60	Parlak / Polished	K86476000001VTEO



Açık Krem / Light Cream

60x60	Mat / Matt	K873731R0001VTEO
60x60	Parlak / Polished	K87374200001VTEO
30x60	Mat / Matt	K873716R0001VTEO
30x60	Parlak / Polished	K87372000001VTEO



Moka / Mocha

60x60	Mat / Matt	K873506R0001VTEO
60x60	Parlak / Polished	K87353200001VTEO
30x60	Mat / Matt	K873440R0001VTEO
30x60	Parlak / Polished	K87347300001VTEO



Açık Gri / Light Grey

60x60	Mat / Matt	K926020R0001VTEO
60x60	Parlak / Polished	K92626300001VTEO
30x60	Mat / Matt	K926042R0001VTEO
30x60	Parlak / Polished	K92603100001VTEO



Gri / Grey

60x60	Mat / Matt	K864491R0001VTEO
60x60	Parlak / Polished	K86479300001VTEO
30x60	Mat / Matt	K864465R0001VTEO
30x60	Parlak / Polished	K86474500001VTEO



Antrasit / Anthracite

60x60	Mat / Matt	K864480R0001VTEO
60x60	Parlak / Polished	K86478200001VTEO
30x60	Mat / Matt	K864454R0001VTEO
30x60	Parlak / Polished	K86473400001VTEO



Kesme Bordür / Cut Border

5x5	Beyaz / White	Mat / Matt	K0815448R001VTEO
5x5	Açık Krem / Light Cream	Mat / Matt	K0815338R001VTEO
5x5	Moka / Mocha	Mat / Matt	K0815818R001VTEO
5x5	Açık Gri / Light Grey	Mat / Matt	K0815708R001VTEO
5x5	Gri / Grey	Mat / Matt	K0815668R001VTEO
5x5	Antrasit / Anthracite	Mat / Matt	K0815558R001VTEO



NITRIUM



PRO

NATURE

NITRIUM

Traverten taşının doğal dokusunu, beton görünümlü modern bir yüzeyle birleştiren seramik serisi. Antik çağ yapılarının tarihten gelen çizgilerini çağdaş mimarinin endüstriyel tasarım trendleri ile yeniden yorumluyor.

Ceramic series which combines the natural texture of travertine stone with a modern concrete surface. It reinterprets the lines from ancient buildings with industrial design trends of contemporary architecture.

Porselen Karolar / Porcelain Tiles

Fon Ebatları / Basic Tile Sizes
60x60 cm (R 597x597 mm)

Yüzey Alternatifleri / Surface Alternatives
FLPR

Fon ve Dekor Renkleri / Basic Tile and Decor Colors

Beyaz / White
Krem / Cream
Gri / Grey

Kullanım Alanları / Usage Areas
Konut / Residential

Döşeme Alanları / Tiling Areas

Yer / Floor
Duvar / Wall

Desen Farklılaşması / Shade Variation Classification

V2

Dona Dayanım / Frost Resistance
Var / Available

Baskı Teknolojisi / Printing Technology
ReaLook

Ürün Standardı / Product Standard
EN14411 Group B1a

Dip Notlar / Footnotes

H R



Duvar Karosu
Wall Tile



Yer Karosu
Floor Tile



Porselen
Porcelain



Konut
Residential



Dona Dayanım
Frost Resistance



Full
Lappato



Desen Farklılaşması
Shade Variation



Rektifiyeli
Non Rectified



Lappato

NITRIUM

Porselen Karolar / Porcelain Tiles



60x60 FLPR K945188FLPR1VTE0

Beyaz / White



60x60 FLPR K945195FLPR1VTE0

Krem / Cream



60x60 FLPR K945187FLPR1VTEO

Gri / Grey



TERRE



PRO

NATURE

TERRE

Klasik cotto görünümünü beton dokusuyla harmanlayarak yeniden yorumlayan seramik serisi. Koleksiyonun modern görünümünü kullandığı mekânlara doğal bir yaşamışlık kazandırıyor.

A ceramic series that reinterprets classic cotto look and blends it with concrete texture. The modern design of the collection brings a natural living experience to the places where it is used.

Porselen ve Seramik Yer Karoları / Porcelain and Ceramic Tiles

Bünye / Body Type

Sırlı Porselen / Glazed Porcelain
Seramik Yer Karosu / Ceramic Floor Tiles

Yüzey Alternatifleri / Surface Alternatives

Mat / Matt

Fon Ebatları / Basic Tile Sizes

45x45 cm
33x33 cm

Fon Renkleri / Basic Tile Colors

Açık Gri / Light Grey
Gri / Grey
Koyu Gri / Dark Grey
Vizon / Mink

Kullanım Alanları / Usage Areas

Konut / Residential
Ticari Alan / Commercial

Döşeme Alanları / Tiling Areas

Yer / Floor
Duvar / Wall

Dona Dayanım / Frost Resistance

Var / Available

Desen Farklılaşması / Shade Variation Classification

V4

Baskı Teknolojisi / Printing Technology

RealLook

Ürün Standardı / Product Standard

EN14411 Group Bla
EN14411 Group Blb

Dip Notlar / Footnotes

H R



Porselen
Porcelain



Yer Karosu
Floor Tile



Duvar Karosu
Wall Tile



Konut
Residential



Dona Dayanım
Frost Resistance



Desen Farklılaşması
Shade Variation



Mat
Matt



Rektifiyesiz
Non Rectified

TERRE



45x45 Mat / Matt K94462900001VTE1

Vizon / Mink



45x45 Mat / Matt K94462900001VTE0

Açık Gri / Light Grey



45x45 Mat / Matt K94462900001VTE0

Gri / Grey



45x45 Mat / Matt K94463000001VTE0

Koyu Gri / Dark Grey

Seramik Yer Karoları / Ceramic Floor Tiles



33x33 Mat / Matt K94506500001VTE0

Vizon / Mink



33x33 Mat / Matt K94506800001VTE0

Açık Gri / Light Grey



33x33 Mat / Matt K94506400001VTE0

Gri / Grey



33x33 Mat / Matt K94506700001VTE0

Koyu Gri / Dark Grey



TRUVA



PRO

NATURE

TRUVA

Helenistik dönemde tüm antik dünyadaki çağdaşları arasında en güzel ve sıra dışı kentlerden biri olarak kabul edilen Truva'dan izler taşıyan seri, yüksek düzeyde bir kültürel yaşantıyı günümüzle harmanlıyor. Cotto tarzının rahatlatıcı etkilerini sıcak tonlarla mekânlara yansıtan seride taba, krem, bej, beyaz ve gri renkleri bulunuyor. Truva seramik yer karoları 33x33 cm ölçülerine sahip.

Carrying traces of Troy that is considered to have been one of the most beautiful and extraordinary cities in hellenistic period, the series blends the high culture of the ancient times with our modern world. Reflecting the comforting effects of cotto style with warm hues, the series is produced in tobacco, beige, cream, white and grey color options. Truva ceramic floor tiles come in 33x33 cm.

Seramik Yer Karoları / Ceramic Floor Tiles

Bünye / Body Type

Yer Karosu / Floor Tile

Yüzey Alternatifleri / Surface Alternatives

Mat / Matt

Fon Ebatları / Basic Tile Sizes

33x33 cm

Fon Renkleri / Basic Tile Colors

Beyaz / White
Krem / Cream
Bej / Beige
Gri / Grey
Taba / Tobacco

Kullanım Alanları / Usage Areas

Konut / Residential

Döşeme Alanları / Tiling Areas

Yer / Floor
Duvar / Wall

Dona Dayanım / Frost Resistance

Var / Available

Desen Farklılaşması / Shade Variation Classification

V4

Baskı Teknolojisi / Printing Technology

ReaLook

Ürün Standardı / Product Standard

EN14411 Group B1b

Dip Notlar / Footnotes

H R



Yer Karosu
Floor Tile



Duvar Karosu
Wall Tile



Konut
Residential



Dona Dayanım
Frost Resistance



Desen Farklılaşması
Shade Variation



Mat
Matt



Rektifiyesiz
Non Rectified

TRUVA

Seramik Yer Karoları / Ceramic Floor Tiles



33x33 Mat / Matt K76685000001VTE0

Beyaz / White



33x33 Mat / Matt K76176200001VTE0

Krem / Cream



33x33 Mat / Matt K76177300001VTE0

Bej / Beige



33x33 Mat / Matt K76178400001VTE0

Gri / Grey



CLAYART



Yer Karoları / Floor Tiles : K946227R0001VTE0 60x60 Clay-cement Açık Gri / Light Cement

Duvar Karoları / Wall Tiles : K946262R0001VTS0 33x100 Clayart Gri / Grey
K946264R0001VTS0 33x100 Clayart Gri Plaster Dekor / Grey Plaster Decor



PRO

NATURE

CLAYART

İç mekân tasarımlarının yükselen trendi beton görünümlü seramik serisi. Kullanıldığı mekânlarda, betonun zamansız güzelliğini kilin doğal sıcaklığı ile birleştiriyor. Üzerindeki üç boyutlu doku sayesinde kullanıldığı duvarlarda doğal bir sıva etkisi oluşturuyor. Betonun sade güzelliğini seramiğin dayanıklılığı ile harmanlayarak şehrin modern dokusunu banyolara taşıyor.

Concrete-textured ceramic collection, which became a rising trend of interior design in recent years. It combines timeless beauty of concrete with natural warmth of clay in the spaces it is used. The collection creates a natural plaster effect on the walls, thanks to its 3D texture. Clayart reflects modern urban atmosphere to bathrooms, blending the pure beauty of concrete with durability of ceramic.

Duvar Karoları / Wall Tiles

Yüzey Alternatifleri / Surface Alternatives
Mat / Matt

Fon Ebatları / Basic Tile Sizes
33x100 cm (R 329x991 mm)

Dekor Ebatları / Decor Sizes
33x100 cm (R 329x991 mm)

**Fon ve Dekor Renkleri /
Basic Tile and Decor Colors**
Beyaz / White
Gri / Grey

Kullanım Alanları / Usage Areas
Konut / Residential

Döşeme Alanları / Tiling Areas
Duvar / Wall

**Uyumlu Yer Karoları /
Compatible Floor Tiles**
Clay-cement
Aspenwood

Dona Dayanım / Frost Resistance
Yok / Not Available

Baskı Teknolojisi / Printing Technology
ReaLook

Ürün Standardı / Product Standard
EN14411 Group BIII

Dip Notlar / Footnotes

H R



Yeni
Novelty



Duvar Karosu
Wall Tile



Konut
Residential



Mat
Matt



Rektifiyeli
Rectified



Desen Farklılaşması
Shade Variation

CLAYART

Duvar Karoları / Wall Tiles



33x100 Mat / Matt K946262R0001VTSO

Gri / Grey



33x100 Mat / Matt K946644R0001VTSO

Beyaz / White



33x100 Mat / Matt K946264R0001VTSO

Plaster Dekor
Gri / Grey



33x100 Mat / Matt K946645R0001VTSO

Plaster Dekor
Beyaz / White



3x100 Mat / Matt K08601300001VTEO

Metal Bordür / Metal Border
Gümüş / Silver



3x100 Mat / Matt K086013LZ001VTEO

Metal Bordür - Logolu / Logo Metal Border - Logo
Gümüş / Silver





Yer Karoları / Floor Tiles : K947039LPR01VTE0 60x60 Lugano Gri / Grey

Duvar Karoları / Wall Tiles : K947034R0001VTS0 40x80 Lugano Beyaz / White
K947035R0001VTS0 40x80 Lugano Beyaz Dekor / White Decor
K947036R0001VTS0 40x80 Lugano Gri / Grey

LUGANO



PRO

NATURE

LUGANO

Geleneksel yapı elemanlarını modern bir tasarımla yeniden yorumlayan beton görünümlü seramik serisi. Endüstriyel mekân tasarımlarının vazgeçilmezi beton dokusunu parlak ve ışıltılı bir yüzey dokusuyla sunarak lüksü yeniden tanımlıyor. Dantel desenli zarif dekorların betonun ham dokusuyla oluşturduğu kontrast, kullanıldığı mekânlara şık ve asil bir atmosfer kazandırıyor. 40x80 ebatlarındaki seramikler yatay, dikey ve karışık döşeme seçenekleri ile etkileyici yüzeyler yaratıyor.

Concrete-looking tile series which reinterprets the conventional building element with a modern design. It redefines the luxury by offering the concrete texture, which is indispensable for industrial interior design, with a bright and glittering surface texture. The contrast that elegant lacework-pattern decors formed with the raw texture of concrete, gives a stylish and noble atmosphere to the spaces it is used. The 40 by 80 tiles create eye-catching surfaces, with horizontal, vertical and mixed tiling options.

Duvar Karoları / Wall Tiles

Yüzey Alternatifleri / Surface Alternatives

Parlak / Glossy

Fon ve Dekor Ebatları /

Basic and Decor Tile Sizes

40x80 cm (R 397x797 mm)

Fon ve Dekor Renkleri /

Basic Tile and Decor Colors

Beyaz / White

Gri / Grey

Kullanım Alanları / Usage Areas

Konut / Residential

Döşeme Alanları / Tiling Areas

Duvar / Wall

Dona Dayanım / Frost Resistance

Yok / Not Available

Baskı Teknolojisi / Printing Technology

RealLook

Ürün Standardı / Product Standard

EN14411 Group BIII

Dip Notlar / Footnotes

H R



Yeni
Novelty



Duvar Karosu
Wall Tile



Konut
Residential



Desen Farklılaşması
Shade Variation



Rektifiyeli
Rectified



Parlak
Glossy

Porselen Karolar / Porcelain Tiles

Bünye / Body Type

Colorbody Porselen / Colorbody Porcelain

Yüzey Alternatifleri / Surface Alternatives

LPR

Fon Ebatları / Basic Tile Sizes

60x60 cm (R 597x597 mm)

Fon Renkleri / Basic Tile Colors

Beyaz / White
Gri / Grey

Kullanım Alanları / Usage Areas

Konut / Residential

Döşeme Alanları / Tiling Areas

Duvar / Wall
Yer / Floor

Dona Dayanım / Frost Resistance

Var / Available

Desen Farklılaşması / Shade Variation Classification

V2

Baskı Teknolojisi / Printing Technology

RealLook

Ürün Standardı / Product Standard

EN14411 Group B1a

Dip Notlar / Footnotes

H R



Yeni
Novelty



Porselen
Porcelain



Yer Karosu
Floor Tile



Duvar Karosu
Wall Tile



Konut
Residential



Dona Dayanım
Frost Resistance



Desen Farklılaşması
Shade Variation



Rektifiyeli
Rectified



Lappato

LUGANO

Duvar Karoları / Wall Tiles



40x80

Parlak / Glossy

K947034R0001VTSO

Beyaz / White



40x80

Parlak / Glossy

K947035R0001VTSO

Dekor / Decor
Beyaz / White



40x80

Parlak / Glossy

K947036R0001VTSO

Gri / Grey



40x80

Parlak / Glossy

K947037R0001VTSO

Dekor / Decor
Gri / Grey

Porselen Karolar / Porcelain Tiles



60x60 LPR K947038LPR01VTE0

Beyaz / White



60x60 LPR K947039LPR01VTE0

Gri / Grey



MILERA

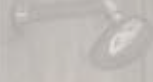

Yer Karoları / Floor Tiles : K947045LPR01VTE0 60x60 Milera Beyaz / White

Duvar Karoları / Wall Tiles : K947040R0001VTS0 40x80 Milera Beyaz / White
K947041R0001VTS0 40x80 Milera Beyaz Dekor / White Decor
K947042R0001VTS0 40x80 Milera Gri / Grey

PRO

NATURE

MILERA

Şehir yaşamının modern ve dinamik çizgilerini yansıtan beton görünümünün antik kentlerin yapı taşı traverten ile sentezlenmiş hali Milera. Koleksiyonun güçlü dinamizmi ve şehirli stili, tasarım trendlerindeki en güncel endüstriyel tarzları kullanıldığı mekânlara taşıyor. Günümüzün yükselen trendlerinden beton dokusu üzerinde silikleşen eskitme dekorları ile koleksiyon vintage etkili mekânlar yaratıyor. 40x80 ebatlarındaki seramikler yatay, dikey ve karışık döşenerek çarpıcı yüzeyler için farklı kullanım seçenekleri sunuyor.

Concrete-looking tile series which reflects the modern and dynamic lines of urban interior design. Strong dynamism and urban style of the collection carries the latest industrial styles in the design trends, to the spaces it is used. The collection creates vintage-effect spaces, with the decors which fade away on the concrete texture, one of the rising trends of today. The 40 by 80 tiles offer different usage options for creating eye-catching surfaces, with horizontal, vertical and mixed tiling options.

Duvar Karoları / Wall Tiles

Yüzey Alternatifleri / Surface Alternatives

Mat / Matt

Fon ve Dekor Ebatları /

Basic and Decor Tile Sizes

40x80 cm (R 397x797 mm)

Fon ve Dekor Renkleri /

Basic Tile and Decor Colors

Beyaz / White

Gri / Grey

Kullanım Alanları / Usage Areas

Konut / Residential

Döşeme Alanları / Tiling Areas

Duvar / Wall

Dona Dayanım / Frost Resistance

Yok / Not Available

Baskı Teknolojisi / Printing Technology

RealLook

Ürün Standardı / Product Standard

EN14411 Group BIII

Dip Notlar / Footnotes

H R



Yeni
Novelty



Duvar Karosu
Wall Tile



Konut
Residential



Desen Farklılaşması
Shade Variation



Rektifiyeli
Rectified



Mat
Matt

Porselen Karolar / Porcelain Tiles

Bünye / Body Type

Colorbody Porselen / Colorbody Porcelain

Yüze Alternatifleri / Surface Alternatives

LPR

Fon Ebatları / Basic Tile Sizes

60x60 cm (R 597x597 mm)

Fon Renkleri / Basic Tile Colors

Beyaz / White
Gri / Grey

Kullanım Alanları / Usage Areas

Konut / Residential

Döşeme Alanları / Tiling Areas

Duvar / Wall
Yer / Floor

Dona Dayanım / Frost Resistance

Var / Available

Desen Farklılaşması / Shade Variation Classification

V2

Baskı Teknolojisi / Printing Technology

RealLook

Ürün Standardı / Product Standard

EN14411 Group Bla

Dip Notlar / Footnotes

H R



Yeni
Novelty



Porselen
Porcelain



Yer Karosu
Floor Tile



Duvar Karosu
Wall Tile



Konut
Residential



Dona Dayanım
Frost Resistance



Desen Farklılaşması
Shade Variation



Rektifiyeli
Rectified



Lappato

MILERA

Duvar Karoları / Wall Tiles



40x80

Mat / Matt

K947040R0001VTSO

Beyaz / White



Beyaz Dekor / White Decor

40x80 Mat / Matt K947041R0001VTSO



40x80

Mat / Matt

K947042R0001VTSO

Gri / Grey



Gri Dekor / Grey Decor

40x80 Mat / Matt K947043R0001VTSO

* Koleksiyon birbiriyle uyumlu iki farklı dekor desenine sahiptir, kutudan karışık çıkabilir.

* The collection has two different decor patterns which are consonant with each other, those could be found as mixed in the product box.

Porselen Karolar / Porcelain Tiles



60x60 LPR K947045LPR01VTE0

Beyaz / White



60x60 LPR K947044LPR01VTE0

Gri / Grey



Duvar Porselen Karoları / Wall Porcelain Tiles : K94497500001VTE0 30X60 Handcrafted Bej / Beige
K94497700001VTE0 30X60 Handcrafted Bej 3D Dekor / 3D Decor Beige
K35700600001VTE0 4X60 Handcrafted Bordür / Border Gold Resin
K94619500001VTE0 30X60 Handcrafted Gri 3D Dekor / 3D Decor Grey

HANDCRAFTED



PRO

NATURE

HANDCRAFTED

El işçiliğinin benzersiz sanatsal havasını yansıtan beton dokulu seramik serisi. İki farklı doğal görünümlü yüzey dokusu ve bu yüzeyleri aynı karoda bir araya getiren dekoru, serinin görsel sadeliğine eşsiz bir tasarım zenginliği kazandırıyor.

Concrete-textured ceramic series which reflect unique artistic style of handcraft. Two natural-looking surface alternatives and a distinctive decor combining these surfaces, create a unique design diversity contrasting visual simplicity of the series.

Duvar Karoları / Wall Tiles

Fon Ebatları / Basic Tile Sizes
30x60 cm (298X598 mm)

**Dekor ve Bordür Ebatları /
Decor and Border Sizes**
30x60 cm (298X598 mm)
4x60 cm (Bordür / Border)

Yüzey Alternatifleri / Surface Alternatives
Mat / Matt

**Fon ve Dekor Renkleri /
Basic Tile and Decor Colors**
Bej / Beige
Altın / Gold

Kullanım Alanları / Usage Areas
Konut / Residential
Ticari Alan / Commercial

Döşeme Alanları / Tiling Areas
Duvar / Wall

**Uyumlu Yer Karoları /
Compatible Floor Tiles**
Meridien

**Desen Farklılaşması /
Shade Variation Classification**
V2

Dona Dayanım / Frost Resistance
Yok / Not Available

Baskı Teknolojisi / Printing Technology
ReaLook

Ürün Standardı / Product Standard
EN14411 Group BIII

Dip Notlar / Footnotes

B



Duvar Karosu
Wall Tile



Ticari Alan
Commercial



Konut
Residential



Ödüllü
Award Winning



Mat
Matt



Rektifiyesiz
Non Rectified



V2
Desen Farklılaşması
Shade Variation



DECOR
PRINTING



GOOD DESIGN
AWARD 2017

HANDCRAFTED

Duvar Karoları / Wall Tiles



30x60 Mat / Matt K94497500001VTE0

Bej / Beige



30x60 Mat / Matt K94497700001VTE0

3D Dekor / 3D Decor
Bej / Beige



30x60 Mat / Matt K94619400001VTE0

Gri / Grey



30x60 Mat / Matt K94619500001VTE0

3D Dekor / 3D Decor
Gri / Grey



4x60 Mat / Matt K35700600001VTE0

Bordur - Border
Altın / Gold Resin

* Vitra, dekor olarak kullanılan ürünlerinde görsel çeşitlilik sağlamak ve birlikte çeşitlilik içinde kullanılabilmesi amacıyla aynı kutu içinden çıkan ürünleri aralarında küçük desen farkları olacak şekilde paketlemektedir.

* Vitra bundles decors in such a way that there will be small pattern differences between them in every box to assure visual diversity.



Yer Karoları / Floor Tiles : K88999400001VTE0 45x45 Bloom Beyaz / White

Duvar Karoları / Wall Tiles : K88359100001VTE0 30x60 Bloom Beyaz / White
K88358000001VTE0 30x60 Bloom Antrasit / Anthracite
K06383400001VTE0 14x60 Bloom Bordür 2 / Border 2 Antrasit / Anthracite

BLOOM



PRO

NATURE

BLOOM

Endüstriyel yalınlığı yansıtan, mekânlara modern bir ruh kazandıran parlak beton görünümlü seramik serisi. Fonlarında kullanılan bulutlu renklerin sakinliği, metalik görünümlü parlak dekorlarının zenginliği ile dengeleniyor. Doğal beton dokulu renk seçenekleri, floral ve soyut dekorları sayesinde kullanıldıkları mekâna modern bir görüntü kazandırıyor.

A ceramic series with bright concrete look, which reflects industrial simplicity and creates modern spaces. The calmness of the cloudy colors used in basic tiles is offset by the richness of metallic and bright decors. Natural concrete color choices together with floral and abstract decors give a modern look to the spaces they are used.

Duvar Karoları / Wall Tiles

Fon ve Dekor Ebatları / Basic Tile and Decor Sizes

20x50 cm (198x498 mm)
30x60 cm (298x598 mm)
14x60 cm (Bordür / Border)
6x60 cm (Bordür / Border)
8,5x60 cm (Süpürgelik / Plinth)
8,5x45 cm (Süpürgelik / Plinth)
8x33 cm (Süpürgelik / Plinth)

Yüzey Alternatifleri / Surface Alternatives

Mat / Mat
Parlak / Glossy

Fon ve Dekor Renkleri / Basic Tile and Decor Colors

Beyaz / White
Krem / Cream
Vizon / Mink
Antrasit / Anthracite

Kullanım Alanları / Usage Areas

Konut / Residential

Döşeme Alanları / Tiling Areas

Duvar / Wall

Dona Dayanım / Frost Resistance

Yok / Not Available

Baskı Teknolojisi / Printing Technology

ReaLook

Ürün Standardı / Product Standard

EN14411 Group BIII

Dip Notlar / Footnotes

B U



Duvar Karosu
Wall Tile



Konut
Residential



Mat
Matt



Parlak
Glossy



Rektifiyesiz
Non Rectified

Porselen ve Seramik Karolar / Porcelain and Ceramic Tiles

Bünye / Body Type

Sırlı Porselen / Glazed Porcelain
Seramik Yer Karosu / Ceramic Floor Tiles

Yüzey Alternatifleri / Surface Alternatives

Mat / Matt

Fon Ebatları / Basic Tile Sizes

60x60 cm (R 597x597 mm)
45x45 cm (447x447 mm)
33x33 cm (327x327 mm)

Fon Renkleri / Basic Tile Colors

Beyaz / White
Krem / Cream
Vizon / Mink
Antrasit / Anthracite

Kullanım Alanları / Usage Areas

Konut / Residential
Ticari Alan (Düşük Trafik) /
Commercial (Low Traffic)

Döşeme Alanları / Tiling Areas

Yer / Floor
Duvar / Wall

Dona Dayanım / Frost Resistance

Var / Available

Desen Farklılaşması / Shade Variation Classification

V1

Baskı Teknolojisi / Printing Technology

ReaLook

Ürün Standardı / Product Standard

EN14411 Group B1a (Glazed Porcelain)
EN14411 Group B1b (Ceramic Floor Tiles)

Dip Notlar / Footnotes

H



Porselen
Porcelain



Yer Karosu
Floor Tile



Konut
Residential



Ticari Alan
Commercial



Dona Dayanım
Frost Resistance



Desen Farklılaşması
Shade Variation



Mat
Matt



Rektifiyesiz
Non Rectified

BLOOM

Duvar Karoları / Wall Tiles



30x60
20x50

Mat / Matt
Mat / Matt

K88359100001VTE0
K90468100001VTE0

Beyaz / White



30x60

Mat / Matt

K06379000001VTE0

Dekor / Decor
Beyaz / White



30x60
20x50

Mat / Matt
Mat / Matt

K88361300001VTEO
K90469200001VTEO

Krem / Cream



30x60

Mat / Matt

K06380100001VTEO

Dekor / Decor
Krem / Cream

BLOOM

Duvar Karoları / Wall Tiles



30x60
20x50

Mat / Matt
Mat / Matt

K88358000001VTE0
K90470300001VTE0

Antrasit / Anthracite

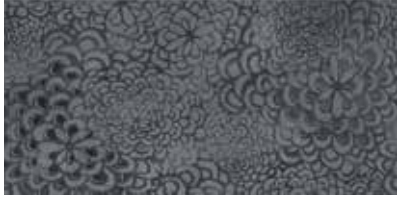

30x60

Mat / Matt

K06377500001VTE0

Dekor / Decor
Antrasit / Anthracite



14x60

Mat / Matt

K06381200001VTE0

Bordür 1 / Border 1
Antrasit / Anthracite



14x60

Mat / Matt

K06383400001VTE0

Bordür 2 / Border 2
Antrasit / Anthracite



20x50

Parlak / Glossy

K07755400001VTE0

Dekor / Decor
Antrasit / Anthracite



30x60
20x50

Mat / Matt
Mat / Matt

K88360200001VTEO
K90471400001VTEO

Vizon / Mink

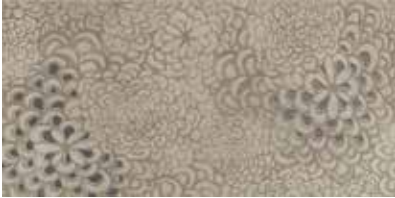

30x60

Mat / Matt

K06378600001VTEO

Dekor / Decor
Vizon / Mink



14x60

Mat / Matt

K06382300001VTEO

Bordür 1 / Border 1
Vizon / Mink



14x60

Mat / Matt

K06384500001VTEO

Bordür 2 / Border 2
Vizon / Mink



20x50

Parlak / Glossy

K07754300001VTEO

Dekor / Decor
Vizon / Mink

BLOOM

Porselen Karolar / Porcelain Tiles



45x45 Mat / Matt K88999400001VTE0

Beyaz / White



45x45 Mat / Matt K89000500001VTE0

Krem / Cream



45x45 Mat / Matt K89002000001VTE0

Vizon / Mink



45x45 Mat / Matt K89001600001VTE0

Antrasit / Anthracite



Süürgelik / Plinth

Beyaz / White	8,5x45	Mat / Matt	K91343100001VTE0
Krem / Cream	8,5x45	Mat / Matt	K91344200001VTE0
Vizon / Mink	8,5x45	Mat / Matt	K91346400001VTE0
Antrasit / Anthracite	8,5x45	Mat / Matt	K91345300001VTE0

Seramik Yer Karoları / Ceramic Floor Tiles

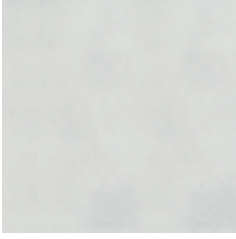

33x33 Mat / Matt K94090400001VTE0

Beyaz / White



33x33 Mat / Matt K94089300001VTE0

Krem / Cream



33x33 Mat / Matt K94219000001VTE0

Vizon / Mink



33x33 Mat / Matt K94220100001VTE0

Antrasit / Anthracite

Süpürgelik / Plinth	Beyaz / White	8x33	Mat / Matt	K94336500001VTE0
	Krem / Cream	8x33	Mat / Matt	K94334300001VTE0
	Vizon / Mink	8x33	Mat / Matt	K94335400001VTE0
	Antrasit / Anthracite	8x33	Mat / Matt	K94333200001VTE0



COSY

Yer Karoları / Floor Tiles : K94435900001VTE0 M45x45 Metro Bazalt / Basalt

Duvar Karoları / Wall Tiles : K94467500001VTE0 25x40 Cosy Bazalt / Basalt
K94467800001VTE0 25x40 Cosy Bazalt Büyük Dalga Dekor / Basalt Large Wave Decor



PRO

NATURE

COSY

Doğal ve modern, sıcak ve soğuk renk seçeneklerine sahip seramik serisi, son moda renklerdeki beton görünümlü karoların eşsiz zarafetini ortaya çıkarıyor. Çağdaş bir atmosfer yaratmak için, serinin akışkan formlu organik rölyef seçenekleri, Metro porselen yer karolarıyla birlikte kullanılabilir.

A ceramic series with natural yet modern warm and cool color options. Cosy unveils the modern elegance of concrete textured tiles in trendy colors. The range has organic reliefs with fluid forms and can be used in combination with Metro porcelain floor tiles to create a contemporary atmosphere.

Duvar Karoları / Wall Tiles

Yüzey Alternatifleri / Surface Alternatives
Mat / Matt

Fon ve Dekor Ebatları / Basic Tile and Decor Sizes
25x40 cm

Fon ve Dekor Renkleri / Basic Tile and Decor Colors
Beyaz / White
Krem / Cream
Gri / Grey
Kahve / Brown
Bazalt / Basalt

Uyumlu Yer Karoları / Compatible Floor Tiles
Metro

Kullanım Alanları / Usage Areas
Konut / Residential

Döşeme Alanları / Tiling Areas
Duvar / Wall

Dona Dayanım / Frost Resistance
Yok / Not Available

Desen Farklılaşması / Shade Variation Classification
V4

Baskı Teknolojisi / Printing Technology
Reaktif Ink / Reactive Ink

Ürün Standardı / Product Standard
EN14411 Group BIII



Duvar Karosu
Wall Tile



Konut
Residential



Desen Farklılaşması
Shade Variation



Mat
Matt



Rektifiyesiz
Non Rectified

COSY

Duvar Karoları / Wall Tiles



25x40 Mat / Matt K94467700001VTE0

Beyaz White



25x40 Mat / Matt K94462300001VTE0

Krem / Cream



25x40 Mat / Matt K94467400001VTE0

Gri / Grey



25x40 Mat / Matt K94467600001VTE0

Kahve / Brown



25x40 Mat / Matt K94467500001VTE0

Bazalt / Basalt



25x40 Mat / Matt K9446800001VTE0

Beyaz Geniş Dalga Dekor / White Large Wave Decor



25x40 Mat / Matt K94462400001VTE0

Krem Geniş Dalga Dekor / Cream Large Wave Decor



25x40 Mat / Matt K94462600001VTE0

Gri Geniş Dalga Dekor / Grey Large Wave Decor



25x40 Mat / Matt K94467900001VTE0

Kahve Geniş Dalga Dekor / Brown Large Wave Decor



25x40 Mat / Matt K94467800001VTE0

Bazalt Geniş Dalga Dekor / Basalt Large Wave Decor



pierre cardin
40 YEARS OF A NEW YORK
THE ALLURE OF BEAUTY

BLACK SWAN



Seramik Yer Karosu / Ceramic Wall Tiles: K94500200001VTE0 33x33 Black Swan Bej / Beige
K94500300001VTE0 33x33 Black Swan Vizon / Mink
K94500400001VTE0 33x33 Black Swan Gri / Grey
K94500500001VTE0 33x33 Black Swan Mix 1 Dekor / Mix Decor 1

PRO

NATURE

BLACK SWAN

Gizemli atmosferi ile romantizmin hiç açılmamış kapılarını aralayan benzersiz bir seramik serisi. Büyük boyutlu çiçek desenleri, buğulu görünümü, fantastik renkleri ve çarpıcı dekorları ile kullanıldığı mekânlara büyümlü bir hava getiriyor.

A unique ceramic series which open new doors of romance, with its mysterious atmosphere. It gives a magical touch to the spaces it is used, with its large-sized flower patterns, misty appearance, fantastic colours and spectacular decors.

Seramik Yer Karosu / Ceramic Floor Tiles

Yüzey Alternatifleri / Surface Alternatives
Mat / Matt

Fon Ebatları / Basic Tile Sizes
33x33 cm (328,5x328,5 mm)

Dekor Ebatları / Decor Sizes
33x33 cm (328,5x328,5 mm)

Fon Renkleri / Basic Tile Colors
Bej / Beige
Gri / Grey
Vizon / Mink

Kullanım Alanları / Usage Areas
Konut / Residential
Ticari Alan / Commercial

Döşeme Alanları / Tiling Areas
Yer / Floor
Duvar / Wall

**Desen Farklılaşması /
Shade Variation Classification**
V3

Dona Dayanım / Frost Resistance
Yok / Not Available

Ürün Standardı / Product Standard
EN14411 Group B1b (Ceramic Floor Tiles)

Dip Notlar / Footnotes



Yer Karosu
Floor Tile



Duvar Karosu
Wall Tile



Konut
Residential



Ticari Alan
Commercial



Ödüllü
Award Winning



Dona Dayanım
Frost Resistance



Mat
Matt



Rektifiyesiz
Non Rectified



Desen Farklılaşması
Shade Variation



BLACK SWAN

Seramik Yer Karosu / Ceramic Floor Tiles



33x33

Mat / Matt

K94500200001VTE0

Bej / Beige



33x33

Mat / Matt

K94500300001VTE0

Vizon / Mink



33x33

Mat / Matt

K94500400001VTE0

Gri / Grey



Mix 1 Dekor / Mix Decor 1
33x33 K94500500001VTEO

* VitrA, dekor olarak kullanılan ürünlerinde görsel çeşitlilik sağlamak ve birlikte çeşitlilik içinde kullanılabilmesi amacıyla aynı kutu içinden çıkan ürünleri aralarında küçük desen farkları olacak şekilde paketlemektedir.

* VitrA, bundles decors in such a way that there will be small pattern differences between them in every box to assure visual diversity.



STONE

CODE

TAŞ ZAMANI

Taş, doğanın hiçbir zaman eskimeyecek sırrı. Dayanıklılığı ve yıllara meydan okuyan yüzüyle size sadeliğin gücünü sunuyor.

The stone is the secret of nature, which will never fade away. It offers you the power of simplicity, with its durability and ever-lasting face.



CARDOSTONE





PRO

NATURE

CARDOSTONE

İtalyan Alpleri'nin sağlam taşı Cardoso'dan esinlenen colobody porselen koleksiyonu. Cardostone, Cardoso taşının doğal yapısındaki beyaz damarlar, taşın doğal rengi gri ve antrasitin yanında bej ve beyaz renk seçenekleri ile hafif soğuk bir seçki sunuyor. Taş dokusunu en gerçekçi haliyle yansıtan rölyefli yüzey seçeneği ise taşın güçlü doğasını yansıtıyor. Cardostone yüksek kaydırmazlık özelliği, temizlenme kolaylığı ve iç mekânda yaratılan estetiği dış mekâna taşımaya sağlayan özel kalınlık alternatifleriyle çağdaş mekânlara uyum sağlıyor.

A colorbody porcelain collection inspired by the durable Cardoso stone of the Italian Alps. Cardostone offers the quintessential white veins of Cardoso stone in natural grey and anthracite colors as well as in a cooler beige and white color choices. The relief surface option, which creates the most realistic appearance of the original stone's texture, reflects Cardostone's powerful nature. Highly anti-slip, easy to clean, and available in a thickness particularly suitable for exteriors, Cardostone perfectly complements all contemporary venues.

Porselen Karolar / Porcelain Tiles

Bünye / Body Type

Colorbody Porselen / Colorbody Porcelain

Fon Ebatları / Basic Tile Sizes

60x120 cm (R 597x1197 mm)

80x80 cm (R 797x797 mm)

40x80 cm (R 397x797 mm)

60x60 cm (R 597x597 mm)

Sırlı porselen / Glazed Porcelain

Fon Ebatları / Basic Tile Sizes

21x24 cm Altıgen/Hexagon (210x241mm)

Yüzey Alternatifleri / Surface Alternatives

R10A

R11

R11C

Fon Renkleri / Basic Tile Colors

Beyaz / White

Bej / Beige

Gri / Grey

Antrasit / Anthracite

Kullanım Alanları / Usage Areas

Konut / Residential

Ticari Alan / Commercial

Döşeme Alanları / Tiling Areas

Yer / Floor

Duvar / Wall

Dona Dayanım / Frost Resistance

Var / Available

Desen Farklılaşması / Shade Variation Classification

V3

Baskı Teknolojisi / Printing Technology

ReaLook

Ürün Standardı / Product Standard

EN14411 Group B1a

Dip Notlar / Footnotes

F H R



Porselen
Porcelain



Yer Karosu
Floor Tile



Duvar Karosu
Wall Tile



Dış Cephe
Facade



Konut
Residential



Ticari Alan
Commercial



Havuz çevresi
Pool Surrounding



Dona Dayanım
Frost Resistance



Desen Farklılaşması
Shade Variation



Mat
Matt



Rektifiyeli
Rectified



20
mm



Küçük Ebat
Mini Size



Modülerlik
Modularity



Yeni
Novelty

CARDOSTONE

Porselen Karolar / Porcelain Tiles



Beyaz / White

60x120 R10A
80x80 R10A
40x80 R10A
60x60 R10A

K947412R0001VTEO
K947260R0001VTEO
K947277R0001VTEO
K947094R0001VTEO

60x60 R11
60x60 R11C

K947548R0001VTEO 20 mm
K947356R0001VTEO



Bej / Beige

60x120 R10A
80x80 R10A
40x80 R10A
60x60 R10A

K947413R0001VTEO
K947261R0001VTEO
K947278R0001VTEO
K947095R0001VTEO

60x60 R11
60x60 R11C

K947549R0001VTEO 20 mm
K947357R0001VTEO



Gri / Grey

60x120 R10A
80x80 R10A
40x80 R10A
60x60 R10A

K947411R0001VTEO
K947093R0001VTEO
K947276R0001VTEO
K947263R0001VTEO

60x60 R11
60x60 R11C

K947547R0001VTEO 20 mm
K947359R0001VTEO



Antrasit / Anthracite

60x120 R10A
80x80 R10A
40x80 R10A
60x60 R10A

K947414R0001VTEO
K947262R0001VTEO
K947279R0001VTEO
K947096R0001VTEO

60x60 R11
60x60 R11C

K947550R0001VTEO 20 mm
K947358R0001VTEO



Yeni
Novelty



Beyaz / White	30x60	R10B	K947269R0001VTE0
Bej / Beige	30x60	R10B	K947271R0001VTE0
Gri / Grey	30x60	R10B	K947273R0001VTE0
Antrasit / Anthracite	30x60	R10B	K947275R0001VTE0

Multi Kesme Bordür / Multi Cut Border
Beyaz / White



Beyaz / White	21x24	Mat/Matt	K94740300001VTE0
Bej / Beige	21x24	Mat/Matt	K94740400001VTE0
Gri / Grey	21x24	Mat/Matt	K94740500001VTE0
Antrasit / Anthracite	21x24	Mat/Matt	K94740600001VTE0

Altıgen Dekor / Hexagon Decor
Beyaz / White

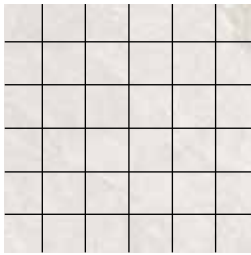

Beyaz / White	5x5	R10B	K947407R0001VTE0
Bej / Beige	5x5	R10B	K947408R0001VTE0
Gri / Grey	5x5	R10B	K947409R0001VTE0
Antrasit / Anthracite	5x5	R10B	K947410R0001VTE0

Kesme Bordür / Cut Border
Beyaz / White



Beyaz / White	10x80	R10A	K947396R0001VTE0
Bej / Beige	10x80	R10A	K947397R0001VTE0
Gri / Grey	10x80	R10A	K947395R0001VTE0
Antrasit / Anthracite	10x80	R10A	K947398R0001VTE0

Süprügelik / Plinth
Beyaz / White

Beyaz / White	8,5x60	R10A	K947400R0001VTE0
Bej / Beige	8,5x60	R10A	K947401R0001VTE0
Gri / Grey	8,5x60	R10A	K947399R0001VTE0
Antrasit / Anthracite	8,5x60	R10A	K947402R0001VTE0



CEPPOSTONE





PRO

NATURE

CEPOSTONE

İtalyan Ceppo di Gré'yi yorumlayan colorbody porselen koleksiyonu. Ceppostone, antik çağlardan bugüne iri taneli çakıl taşı dokusuyla karakteristik bir kullanım sağlayan özel taşı yeniden yorumluyor. ColorCode yaklaşımındaki gri ve vizonu, modüler ebatlarla bir araya getiren koleksiyon, colorbody bünyesinin dayanıklılığı sayesinde tüm kullanım koşullarına uyum sağlıyor.

A colorbody porcelain collection that interprets the elegant Ceppo di Gré of Italy. Ceppostone reinvents the large, granular texture of Ceppo di Gré, a special stone valued for its beauty and strength since ancient times. The collection brings together the grey and mink of the ColorCode approach with modular sizes and offers a high degree of durability that makes it suitable for all usage conditions.

Porselen Karolar / Porcelain Tiles

Bünye / Body Type

Colorbody Porselen / Colorbody Porcelain

Fon Ebatları / Basic Tile Sizes

60x120 cm (R 597x1197 mm)

80x80 cm (R 797x797 mm)

40x80 cm (R 397x797 mm)

60x60 cm (R 597x597 mm)

Yüzey Alternatifleri / Surface Alternatives

R9

R11

R11C

Fon Renkleri / Basic Tile Colors

Vizon - Mink

Koyu Grej - Dark Greige

Gri - Grey

Koyu Gri - Dark Grey

Kullanım Alanları / Usage Areas

Konut / Residential

Ticari Alan / Commercial

Döşeme Alanları / Tiling Areas

Yer / Floor

Duvar / Wall

Dona Dayanım / Frost Resistance

Var / Available

Desen Farklılaşması / Shade Variation Classification

V2

Baskı Teknolojisi / Printing Technology

ReaLook

Ürün Standardı / Product Standard

EN14411 Group Bla

Dip Notlar / Footnotes

F H R



Porselen
Porcelain



Yer Karosu
Floor Tile



Duvar Karosu
Wall Tile



Konut
Residential



Ticari Alan
Commercial



20
mm



Dona Dayanım
Frost Resistance



V2
Desen Farklılaşması
Shade Variation



Mat
Matt



Rektifiyeli
Rectified



Modülerlik
Modularity



Yeni
Novelty

CEPPOSTONE

Porselen Karolar / Porcelain Tiles



Vizon - Mink

60x120	R9	K947430R0001VTE0
80x80	R9	K947184R0001VTE0
40x80	R9	K947192R0001VTE0
60x60	R9	K947307R0001VTE0
60x60	R11C	K947361R0001VTE0
60x60	R11	K947470R0001VTE0 - 20 mm



Koyu Grej - Dark Greige

60x120	R9	K947520R0001VTE0
80x80	R9	K947464R0001VTE0
40x80	R9	K947506R0001VTE0
60x60	R9	K947320R0001VTE0
60x60	R11C	K947522R0001VTE0
60x60	R11	K947523R0001VTE0 - 20 mm

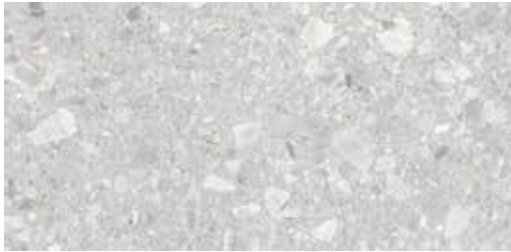

Gri / Grey

60x120	R9	K947434R0001VTE0
80x80	R9	K947198R0001VTE0
40x80	R9	K947204R0001VTE0
60x60	R9	K947316R0001VTE0
60x60	R11C	K947363R0001VTE0
60x60	R11	K947472R0001VTE0 - 20 mm

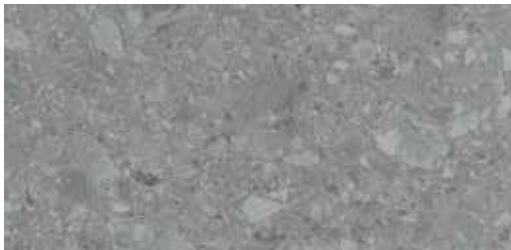

Koyu Gri - Dark Grey

60x120	R9	K947521R0001VTE0
80x80	R9	K947463R0001VTE0
40x80	R9	K947507R0001VTE0
60x60	R9	K947524R0001VTE0
60x60	R11C	K947362R0001VTE0
60x60	R1	K947471R0001VTE0 - 20 mm



Yeni
Novelty



Vizon / Mink	30x60	R10B	K947311R0001VTE0
Koyu Grej / Dark Greige	30x60	R10B	K947497R0001VTE0
Gri / Grey	30x60	R10B	K947318R0001VTE0
Koyu Gri / Dark Grey	30x60	R10B	K947498R0001VTE0

Multi Kesme Bordür / Multi Cut Border
Vizon / Mink

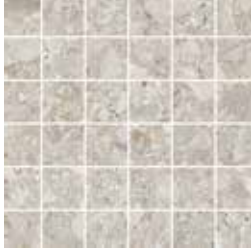

Vizon / Mink	5x5	R10B	K947429R0001VTE0
Koyu Grej / Dark Greige	5x5	R10B	K947512R0001VTE0
Gri / Grey	5x5	R10B	K947433R0001VTE0
Koyu Gri / Dark Grey	5x5	R10B	K947513R0001VTE0

Kesme Bordür / Cut Border
Vizon / Mink



Vizon / Mink	10x80	R9	K947427R0001VTE0
Koyu Grej / Dark Greige	10x80	R9	K947483R0001VTE0
Gri / Grey	10x80	R9	K947431R0001VTE0
Koyu Gri / Dark Grey	10x80	R9	K947484R0001VTE0

Süpürgelik / Plinth
Beyaz / White

Vizon / Mink	8,5x60	R9	K947428R0001VTE0
Koyu Grej / Dark Greige	8,5x60	R9	K947528R0001VTE0
Gri / Grey	8,5x60	R9	K947432R0001VTE0
Koyu Gri / Dark Grey	8,5x60	R9	K947529R0001VTE0



STONELEVEL





PRO

NATURE

STONELEVEL

Beton ve taşı bir yüzde birleştiren colorbody porselen koleksiyonu. Stonelevel, doğal taşın tanecikli yapısı ve brüt beton dokusunu, doğal sıcak tonlarla buluşturarak diğer doğal taş görünümlü koleksiyonlardan ayırıyor. Modüler ebatları ve organik çizgilerden oluşan rölyef dekorlarıyla Stonelevel, döşeme çeşitliliğine imkân tanıyor.

A colorbody porcelain collection combining the look and feel of concrete and stone. Stonelevel merges the granulated structure of natural stone into the texture of exposed concrete and adds warm natural colors to create a one-of-a-kind natural stone collection. The collection's modular sizes and decorative tiles with organic relief patterns can be mixed and matched to create a wide variety of tiling solutions.

Porselen Karolar / Porcelain Tiles

Bünye / Body Type

Colorbody Porselen / Colorbody Porcelain

Fon Ebatları / Basic Tile Sizes

80x80 cm (R 797x797 mm)

40x80 cm (R 397x797 mm)

60x60 cm (R 597x597 mm)

30x60 cm (R 297x597 mm)

Yüzey Alternatifleri / Surface Alternatives

R10A

R9 LPR

Fon Renkleri / Basic Tile Colors

Fildişi / Ivory

Grej / Greige

Bazalt / Basalt

Kullanım Alanları / Usage Areas

Konut / Residential

Ticari Alan / Commercial

Döşeme Alanları / Tiling Areas

Yer / Floor

Duvar / Wall

Dona Dayanım / Frost Resistance

Var / Available

Desen Farklılaşması / Shade Variation Classification

V2

Baskı Teknolojisi / Printing Technology

ReaLook

Ürün Standardı / Product Standard

EN14411 Group Bla

Dip Notlar / Footnotes

F H R



Porselen
Porcelain



Yer Karosu
Floor Tile



Duvar Karosu
Wall Tile



Konut
Residential



Ticari Alan
Commercial



Dona Dayanım
Frost Resistance



R9 Lappato



Soft R10



Mat
Matt



Desen Farklılaşması
Shade Variation



Rektifiyeli
Rectified



Modülerlik
Modularity



Yeni
Novelty

STONELEVEL

Porselen Karolar / Porcelain Tiles



Fildişi / Ivory

80x80	R10A	K947281R0001VTE0
40x80	R10A	K947287R0001VTE0
60x60	R10A	K947099R0001VTE0
30x60	R10A	K947295R0001VTE0

80x80	R9 LPR	K947281LPR01VTE0
40x80	R9 LPR	K947287LPR01VTE0
60x60	R9 LPR	K947099LPR01VTE0
30x60	R9 LPR	K947804LPR01VTE0



Grej / Greige

80x80	R10A	K947097R0001VTE0
40x80	R10A	K947285R0001VTE0
60x60	R10A	K947293R0001VTE0
30x60	R10A	K947415R0001VTE0

80x80	R9 LPR	K947097LPR01VTE0
40x80	R9 LPR	K947285LPR01VTE0
60x60	R9 LPR	K947293LPR01VTE0
30x60	R9 LPR	K947803LPR01VTE0



Bazalt / Basalt

80x80	R10A	K947282R0001VTE0
40x80	R10A	K947288R0001VTE0
60x60	R10A	K947100R0001VTE0
30x60	R10A	K947296R0001VTE0

80x80	R9 LPR	K947282LPR01VTE0
40x80	R9 LPR	K947288LPR01VTE0
60x60	R9 LPR	K947100LPR01VTE0
30x60	R9 LPR	K947802LPR01VTE0

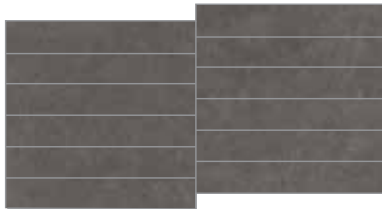

Slim Kesme / Slim Cut

Fildişi / Ivory	5x15	R10B	K947370R0001VTE0
Grej / Greige	5x15	R10B	K947366R0001VTE0
Bazalt / Basalt	5x15	R10B	K947505R0001VTE0



Süpürgelik / Plinth
Beyaz / White

Fildişi / Ivory	10x80	R10A	K947427R0001VTE0
Grej / Greige	10x80	R10A	K947419R0001VTE0
Bazalt / Basalt	10x80	R10A	K947421R0001VTE0

Grej / Greige	8,5x60	R10A	K947418R0001VTE0
Fildişi / Ivory	8,5x60	R10A	K947416R0001VTE0
Bazalt / Basalt	8,5x60	R10A	K947417R0001VTE0



Yeni
Novelty



40x80 K947291R0001VTE0

3D Rölyef / 3D Relief
Fildişi / Ivory



40x80 K947289R0001VTE0

3D Rölyef / 3D Relief
Grej / Greige



40x80 K947292R0001VTE0

3D Rölyef / 3D Relief
Bazalt / Basalt

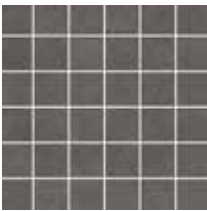

Fildişi / Ivory	5x5	R10B	K947518R0001VTE0
Grej / Greige	5x5	R10B	K947519R0001VTE0
Bazalt / Basalt	5x5	R10B	K947517R0001VTE0

Kesme Bordür / Cut Border
Bazalt / Basalt



Mix	5x5	R10B	K947426R0001VTE0
-----	-----	------	------------------

Kesme Bordür / Cut Border
Mix



Duvar Porselen Karoları / Wall Porcelain Tiles : K945842R0001VTE0 80x80 Urban Blue Antrasit Antik / Anthracite Antique
K945823R0001VTE0 40x80 Urban Blue Koyu Gri Antik / Dark Grey Antique

Yer Porselen Karoları / Floor Porcelain Tiles : K945842R0001VTE0 80x80 Urban Blue Antrasit Antik / Anthracite Antique
K945841R0001VTE0 80x80 Urban Blue Koyu Gri Antik / Dark Grey Antique

URBAN BLUE





Duvar Porselen Karoları / Wall Porcelain Tiles : K945842R0001VTE0 80x80 Urban Blue Antrasit Antik / Anthracite Antique

Yer Porselen Karoları / Floor Porcelain Tiles : K945841R0001VTE0 M80x80 Urban Blue K.Gri Antik / Dark Grey Antique

URBAN BLUE





PRO

NATURE

URBAN BLUE

Tasarım dünyasının yükselen trendi blue stone doğal taşının çarpıcı güzelliğini, antrasit ve gri tonlarıyla yeniden yorumlayan seramik serisi. Doğal taşın damarlı ve fosil yapılı dokusunun antik yüzeylerle zenginleştiği koleksiyonda, özgün ve şık tasarımlara olanak sağlanıyor.

A ceramic series reinterpreting the stunning beauty of the popular natural blue stone with anthracite and grey tones. The collection, enriched by veiny and fossil surface textures, helps creating unique and chic designs.

Porselen Karolar / Porcelain Tiles

Bünye / Body Type

Colorbody Porselen / Colorbody Porcelain

Fon Ebatları / Basic Tile Sizes

80x80 cm (R 797x797 mm)

40x80 cm (R 397x797 mm)

10x80 cm (R 97x797 mm)

Yüzey Alternatifleri / Surface Alternatives

R9

Antik/Antique

Dekor Ebatları / Decor Sizes

5x5 cm Kesme Dekor / Cut Decor

Fon Renkleri / Basic Tile Colors

Koyu Gri / Dark Grey

Antrasit / Anthracite

Kullanım Alanları / Usage Areas

Konut / Residential

Ticari Alan / Commercial

Döşeme Alanları / Tiling Areas

Yer / Floor

Duvar / Wall

Dona Dayanım / Frost Resistance

Var / Available

Desen Farklılaşması / Shade Variation Classification

V4

Baskı Teknolojisi / Printing Technology

ReaLook

Ürün Standardı / Product Standard

EN14411 Group B1a

Dip Notlar / Footnotes

F H R



Porselen
Porcelain



Yer Karosu
Floor Tile



Duvar Karosu
Wall Tile



Dış Cephe
Facade



Dış Mekanlar
Outdoors



Konut
Residential



Ticari Alan
Commercial



Dona Dayanım
Frost Resistance



Desen Farklılaşması
Shade Variation



Mat
Matt



Rektifiyeli
Rectified



Modülerlik
Modularity



Ödüllü
Award Winning



URBAN BLUE

Porselen Karolar / Porcelain Tiles



80x80 R9 K945839R0001VTE0
40x80 R9 K945824R0001VTE0

Antrasit / Anthracite

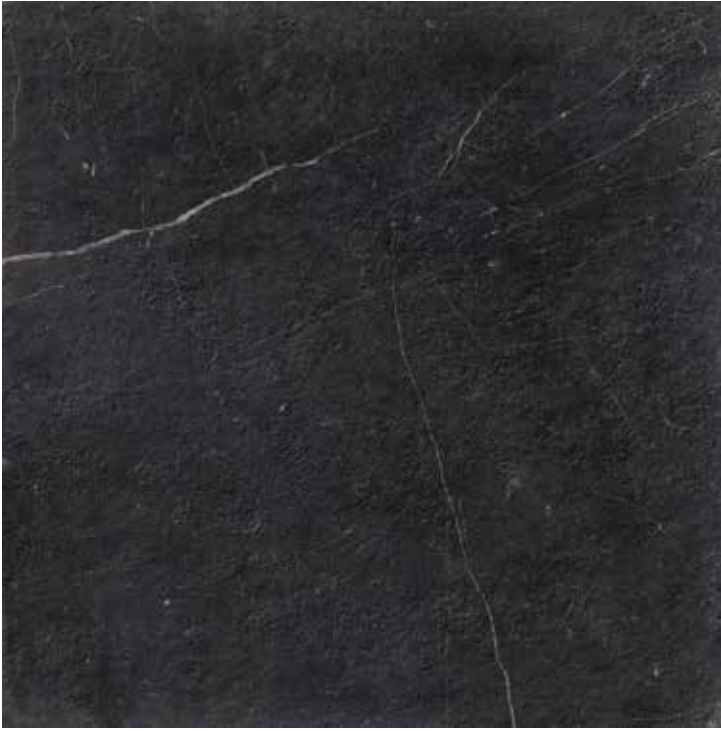

80x80 Antik / Antique K945842R0001VTE0
10x80 Antik / Antique K946052R0001VTE0

Antrasit / Anthracite

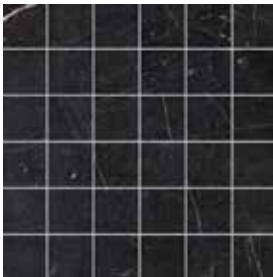

5x5 Antik/Antique R10B K9458308R001VTE0

Kesme Mozaik Dekor / Cut Mosaic Dekor
Antrasit / Anthracite



10x80 R9 K945818R0001VTE0

Süürgelik / Plinth
Antrasit / Anthracite



80x80 R9
40x80 R9

K945837R0001VTE0
K945823R0001VTE0

Koyu Gri / Dark Grey

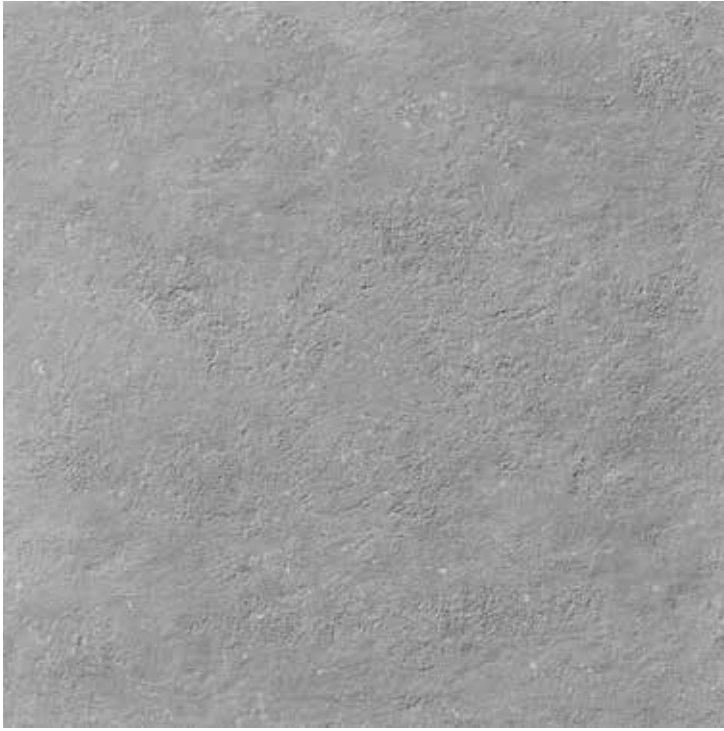

80x80 Antik / Antique
10x80 Antik / Antique

K945841R0001VTE0
K946023R0001VTE0

Koyu Gri / Dark Grey

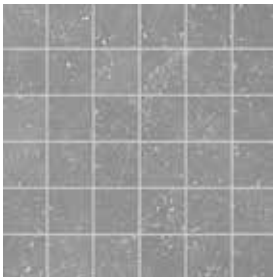

5x5

Antik/Antique R10B

K9458298R001VTE0

Kesme Mozaik Dekor / Cut Mosaic Decor
Koyu Gri / Dark Grey



10x80 R9

K945817R0001VTE0

Süpürgelik / Plinth
Koyu Gri / Dark Grey



Duvar Porselen Karoları / Wall Porcelain Tiles : K94642300001VTE0 Cityrug 21x24 Soğuk Dekor / Cold Decor

Yer Porselen Karoları / Floor Porcelain Tiles : K94642100001VTE0 Cityrug 21x24 Taş Beyaz / Stone White
K94642300001VTE0 Cityrug 21x24 Soğuk Dekor / Cold Decor

CITYRUG





PRO

NATURE

CITYRUG

Modern geometrik çizgileri, moda renkleri ve benzersiz kuvars taşı dokusuyla mekânlara boyut kazandıran yenilikçi porselen serisi. Minimal hatları ve altıgen formlarıyla City Rug, sıcak ve soğuk olarak gruplanan iki renk paleti seçeneği ile iç mekânlarda sınırsız kombinasyon zenginliği sunuyor.

An innovative ceramic collection which adds a new dimension to the spaces, with its modern geometric lines, trendy colours and unique quartz stone texture. City Rug with its minimal lines and hexagonal forms offers an unlimited richness of combination at the interior spaces, with two colour range options grouped as warm and cool.

Porselen Karolar / Porcelain Tiles

Bünye / Body Type

Sırlı Porselen / Glazed Porcelain

Fon Ebatları / Basic Tile Sizes

21x24 cm Hexagon

Yüzey Alternatifleri / Surface Alternatives

Mat / Matt

Fon ve Dekor Renkleri / Basic and Decor Tile Colors

Taş Beyaz / Stone White
Sıcak Dekor / Warm Decor
Soğuk Dekor / Cold Decor

Kullanım Alanları / Usage Areas

Konut / Residential

Döşeme Alanları / Tiling Areas

Yer / Floor
Duvar / Wall

Dona Dayanım / Frost Resistance

Var / Available

Baskı Teknolojisi / Printing Technology

ReaLook

Ürün Standardı / Product Standard

EN14411 Group Bla

Dip Notlar / Footnotes

F H



Porselen
Porcelain



Yer Karosu
Floor Tile



Duvar Karosu
Wall Tile



Konut
Residential



Dona Dayanım
Frost Resistance



Mat
Matt



Rektifiyesiz
Non Rectified

CITYRUG

Porselen Karolar / Porcelain Tiles

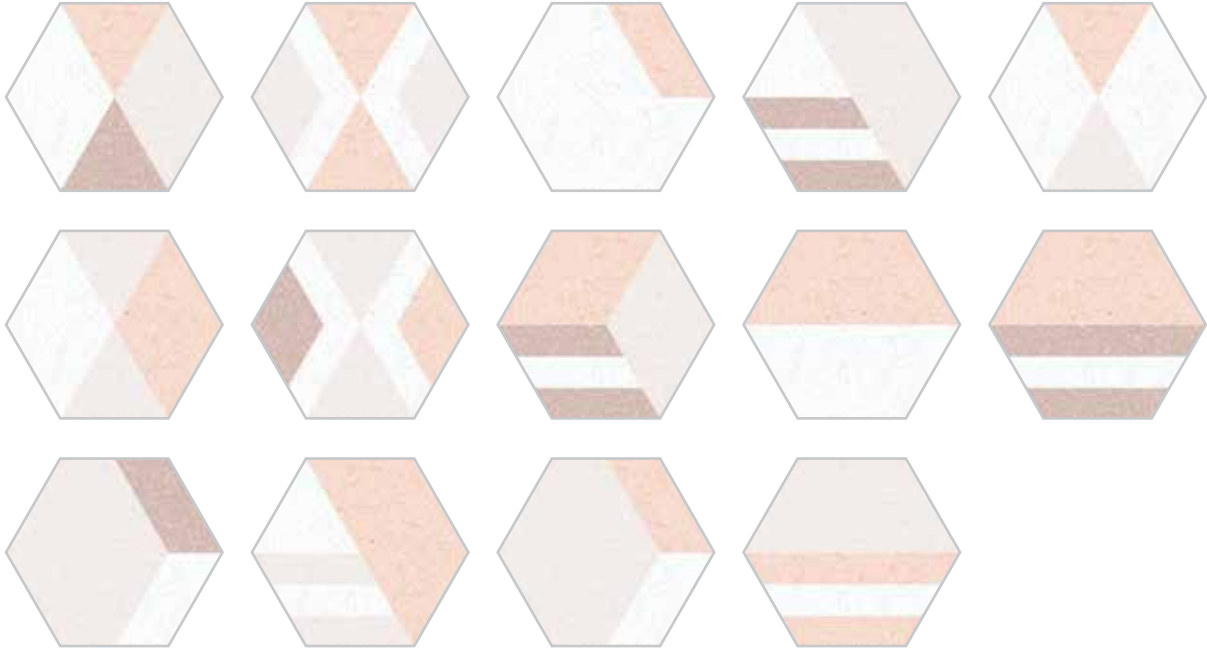

Hexagon
Sıcak Dekor / Warm Decor

21x24 Mat/Matt K94642200001VTE0

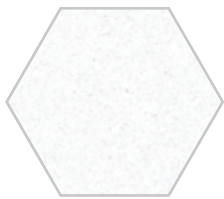

Hexagon
Taş Beyaz / Stone White

21x24 Mat/Matt K94642100001VTE0

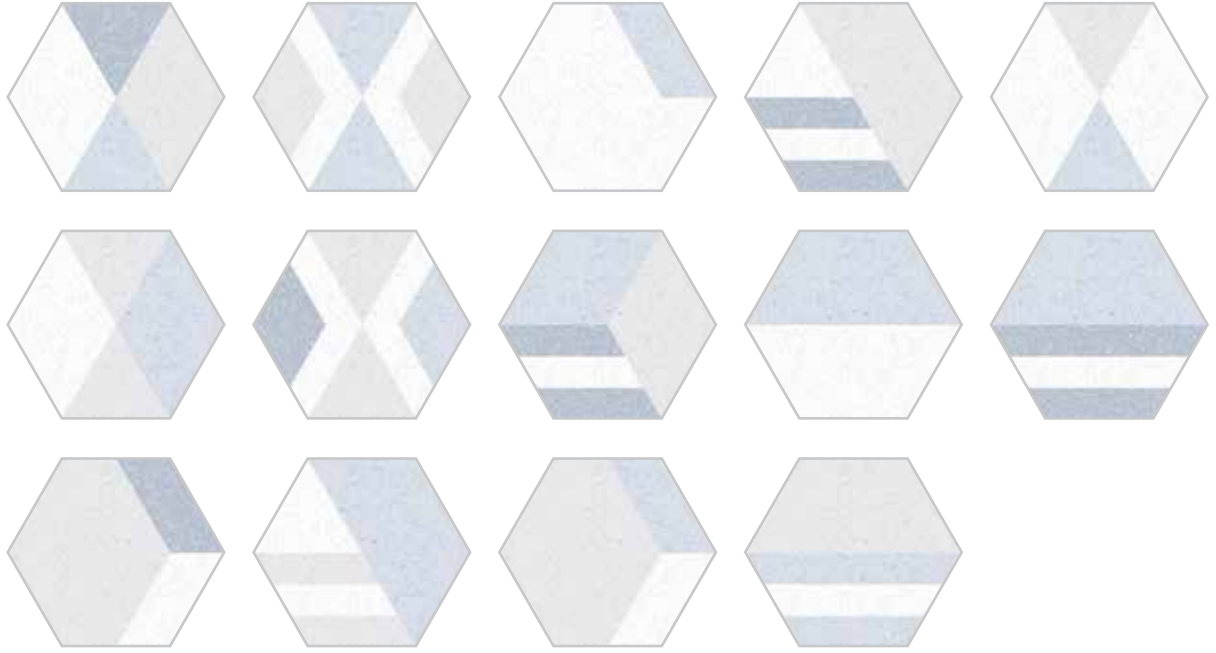

Hexagon
Soğuk Dekor / Cold Decor

21x24 Mat/Matt K94642300001VTE0



Duvar Porselen Karoları / Wall Porcelain Tiles : K94606600001VTE0 7.5x30 Slatemix Antrasit / Anthracite

SLATEMIX





Duvar Porselen Karoları / Wall Porcelain Tiles : K94606800001VTE0 M7.5x30 Slatemix Multicolor
K94607100001VTE0 M15x15 Slatemix Multicolor

PRO

NATURE

SLATEMIX

Porselen Karolar / Porcelain Tiles

Bünye / Body Type

Sırlı porselen / Glazed Porcelain

Fon Ebatları / Basic Tile Sizes

7.5x30 cm (72x297mm)

15x15 cm (147x147mm)

Yüzey Alternatifleri / Surface Alternatives

Mat / Matt

Fon Renkleri / Basic Tile Colors

Koyu Gri / Dark Grey

Antrasit / Anthracite

Multicolor / Multicolor

Kullanım Alanları / Usage Areas

Konut / Residential

Ticari Alan / Commercial

Döşeme Alanları / Tiling Areas

Yer / Floor

Duvar / Wall

Dona Dayanım / Frost Resistance

Var / Available

Desen Farklılaşması / Shade Variation Classification

V4

Baskı Teknolojisi / Printing Technology

ReaLook

Ürün Standardı / Product Standard

EN14411 Group B1a

Dip Notlar / Footnotes

H R

Taş dokulu seramik karoları Slatemix koleksiyonu, zamana karşı koyan mekânlar tasarlama konsepti ile yaratıldı.

Koleksiyonda zamansız, şık ve elegan yansımaları mekânlara taşıyan antrasit ve gri gibi doğal taş renkleri kullanılıyor.

Ardesia taşından esinlenilerek tasarlanan Slatemix, hem iç mekânlar hem de yalın ve doğal dış mekânlar için çözümler sunuyor. Ürün yelpazesinde zengin yüzey desenleri ve ton renkleri ile doğal taşın özü korunuyor.

The concept of Slatemix collection, stone textured ceramic tiles, is to create spaces that would feel timeless in design.

The natural stone colors like anthracite and gray are the best way to illustrate the feel of elegance and luxury along with the sense of timelessness. The collection strives for perfection, completion and beauty for both interior spaces and simple yet natural exterior solutions, inspired by the ardesia stone. Slatemix offers rich face variation retaining the essence of natural stone through its surface pattern and tonal colors.



Porselen
Porcelain



Yer Karosu
Floor Tile



Duvar Karosu
Wall Tile



Diş Cephe
Facade



Konut
Residential



Dona Dayanım
Frost Resistance



Desen Farklılaşması
Shade Variation



Mat
Matt



Rektifiyesiz
Non-Rectified



Küçük Ebat
Mini Size

SLATEMIX

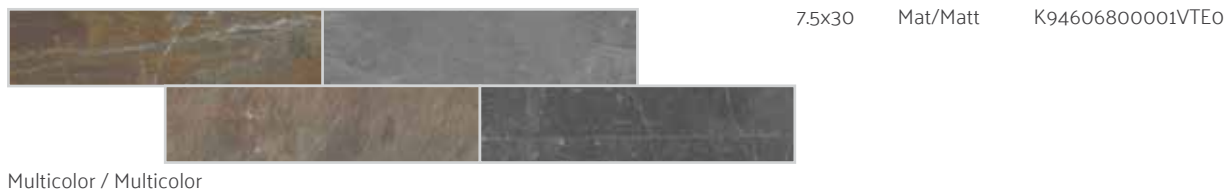

7.5x30 Mat/Matt K94606800001VTEO



7.5x30 Mat/Matt K94606700001VTEO



7.5x30 Mat/Matt K94606600001VTEO

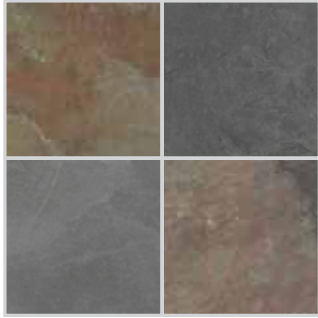

15x15

Mat/Matt

K94607100001VTE0

Multicolor / Multicolor

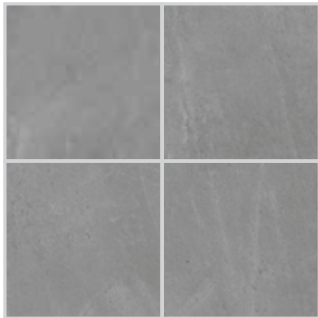

15x15

Mat/Matt

K94607000001VTE0

Koyu Gri / Dark Grey

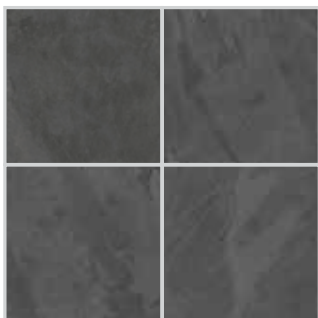

15x15

Mat/Matt

K94606900001VTE0

Antrasit / Anthracite



Yer Karoları / Floor Tiles : K944552R0001VTEO 60X60 Techslate Koyu Gri / Dark Grey

Duvar Karoları / Wall Tiles : K944553R0001VTEO 60X60 Techslate Antrasit / Anthracite
K944549R0001VTEO 30X60 Techslate Antrasit / Anthracite
K944893R0001VTEO 60X60 Techslate Hexagon Antrasit / Anthracite
K944896R0001VTEO 60X60 Techslate Hexagon Antrasit Random / Anthracite
K944899R0001VTEO 60X60 Techslate Hexagon Antrasit Rigato / Anthracite

TECH-SLATE



PRO

NATURE

TECH-SLATE

Zengin antrasit ve gri renk tonlarını çarpıcı yüzey dokuları ile birlikte kullanma fırsatları sunan taş dokulu seramik serisi. Koleksiyon aynı zamanda Ardesia taşının doğal görünümünden ilham alan farklı yüzey ve kesimde dekorlarla zenginleştirilmiştir.

A stone textured ceramic tiles collection offering the Opportunity to use rich shades of anthracite and gray with striking surface textures. The collection is also enriched with shapes and diagonal cuts inspired by the natural look of ardesia stone.

Porselen Karolar / Porcelain Tiles

Bünye / Body Type

Colorbody Porselen / Colorbody Porcelain

Fon Ebatları / Basic Tile Sizes

45x90 (R 447x897 mm)

60x60 (R 597x597 mm)

30x60 (R 397x597 mm)

15x90 (R 147x897 mm)

Yüzey Alternatifleri / Surface Alternatives

R10A

Fon Renkleri / Basic Tile Colors

Beyaz / White

Koyu Gri / Dark Grey

Antrasit / Anthracite

Kullanım Alanları / Usage Areas

Konut / Residential

Ticari Alan / Commercial

Döşeme Alanları / Tiling Areas

Yer / Floor

Duvar / Wall

Dona Dayanım / Frost Resistance

Var / Available

Desen Farklılaşması / Shade Variation Classification

V4

Baskı Teknolojisi / Printing Technology

ReaLook

Ürün Standardı / Product Standard

EN14411 Group Bla

Dip Notlar / Footnotes

H R



Porselen
Porcelain



Yer Karosu
Floor Tile



Duvar Karosu
Wall Tile



Dış Cephe
Facade



Konut
Residential



Ticari Alan
Commercial



Dona Dayanım
Frost Resistance



Desen Farklılaşması
Shade Variation



Mat
Matt



Rektifiyeli
Rectified



reddot design award
winner 2017

TECH-SLATE

Porselen Karolar / Porcelain Tiles



60x60 R10A K944550R0001VTE0
30x60 R10A K944546R0001VTE0

Beyaz / White



60x60 R10A K944552R0001VTE0
30x60 R10A K944548R0001VTE0

Koyu Gri / Dark Grey



60x60 R10A K944553R0001VTE0
30x60 R10A K944549R0001VTE0

Antrasit / Anthracite



60x60 Beyaz/White R10A K944891R0001VTE0
60x60 K. Gri / D. Grey R10A K944892R0001VTE0
60x60 Antrasit / Anthracite R10A K944893R0001VTE0

Altigen Dekor / Hexagon Dekor
Antrasit / Anthracite

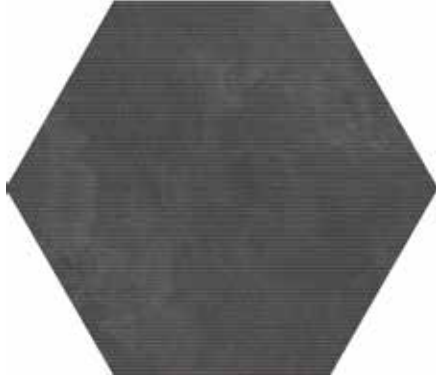

60x60	Beyaz/White	K944897R0001VTE0
60x60	K. Gri / D. Grey	K944898R0001VTE0
60x60	Antrasit / Anthracite	K944899R0001VTE0

Altıgen Rigato Dekor / Hexagon Rigato Decor
Antrasit / Anthracite



30x60	Beyaz/White	K9459508R001VTE0
30x60	K. Gri / D. Grey	K9459518R001VTE0
30x60	Antrasit / Anthracite	K9461938R001VTE0

Kesme Bordür / Cut Border
Beyaz / White

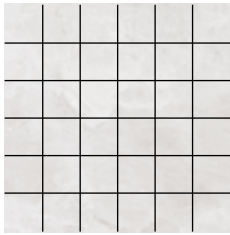

5x5	Beyaz/White	K9459168R001VTE0
5x5	K. Gri / D. Grey	K9459158R001VTE0
5x5	Antrasit / Anthracite	K9459148R001VTE0

Kesme Mozaik / Cut Mosaic
Beyaz / White

Duvar Karoları / Wall Tiles



30x60	Mat / Matt	K94595200001VTE0
-------	------------	------------------

Beyaz / White



BRITISH STONE



Yer Karoları / Floor Tiles : K944433R0001VTE0 60x60 British Stone Beyaz / White

Duvar Karoları / Wall Tiles : K944427R0001VTE0 30x60 British Stone Beyaz / White

PRO

NATURE

BRITISH STONE

Doğal taşın pozitif enerjisini ve rahatlatıcı etkisini mekânlara taşıyan yeni seramik serisi. British Stone, doğal taş görünümünü doğadan renklerle buluşturarak mekânlarda güçlü bir etki yaratıyor.

A new ceramic series that brings the positive energy and relaxing effect of natural stone to spaces. British Stone creates a powerful effect in spaces by combining natural stone look with natural hues.

Porselen Karolar / Porcelain Tiles

Bünye / Body Type

Colorbody Porselen / Colorbody Porcelain

Yüzey Alternatifleri / Surface Alternatives

R10

LPR

Fon Ebatları / Basic Tile Sizes

60x120 cm (R 597x1197 mm)

60x60 cm (R 597x597 mm)

20x120 cm (R 197x1197 mm)

30x60 cm (R 297x597 mm)

45x90 cm (R 447x897 mm)

Bordürler / Borders

5x5 cm (Kesme Bordür / Cut Border)

Fon ve Dekor Renkleri /

Basic Tile and Decor Colors

Beyaz / White

Bej / Beige

Gri / Grey

Antrasit / Anthracite

Kullanım Alanları / Usage Areas

Konut / Residential

Ticari Alan / Commercial

Döşeme Alanları / Tiling Areas

Yer / Floor

Duvar / Wall

Dona Dayanım / Frost Resistance

Var / Available

Desen Farklılaşması /

Shade Variation Classification

V4

Baskı Teknolojisi / Printing Technology

ReaLook

Ürün Standardı / Product Standard

EN14411 Group B1a

Dip Notlar / Footnotes

H R



Porselen
Porcelain



Yer Karosu
Floor Tile



Duvar Karosu
Wall Tile



Dış Cephe
Facade



Konut
Residential



Ticari Alan
Commercial



Dona Dayanım
Frost Resistance



Desen Farklılaşması
Shade Variation



Mat
Matt



Lappato



Rektifiyeli
Rectified

PRO

NATURE

Duvar Karoları / Wall Tiles

Yüzey Alternatifleri / Surface Alternatives
Mat / Matt

Fon Ebatları / Basic Tile Sizes
30x60 cm (298x598 mm)

Fon Renkleri / Basic Tile Colors
Açık Bej / Light Beige
Açık Gri / Light Grey
Antrasit / Anthracite

Kullanım Alanları / Usage Areas
Konut / Residential

Döşeme Alanları / Tiling Areas
Duvar / Wall

Dona Dayanım / Frost Resistance
Yok / Not Available

Baskı Teknolojisi / Printing Technology
RealLook

Ürün Standardı / Product Standard
EN14411 Group BIII

Dip Notlar / Footnotes
B H R



Duvar Karosu
Wall Tile

Konut
Residential

Rektifiyesiz
Non Rectified

Mat
Matt

BRITISH STONE

Porselen Karolar / Porcelain Tiles



60x120	R10A	K944431R0001VTE0
20x120	R10A	K944426R0001VTE0
60x60	R10A	K944433R0001VTE0
30x60	R10A	K944427R0001VTE0

60x120	LPR	K944431LPR01VTE0
60x60	LPR	K944433LPR01VTE0
20x120	LPR	K944426LPR01VTE0
45x90	LPR	K944571LPR01VTE0
30x60	LPR	K944427LPR01VTE0

Beyaz / White



5x5	R10B	K0862218R001VTE0
5x5	LPR	K0862208LPR1VTE0

Kesme Bordür / Cut Border
Beyaz / White



8.5x60	R10	K944694R0001VTE0
8.5x60	LPR	K944696LPR01VTE0

Süpürgelik / Plinth
Beyaz / White



60x120	R10A	K932891R0001VTE0
20x120	R10A	K932924R0001VTE0
60x60	R10A	K937474R0001VTE0
30x60	R10A	K937430R0001VTE0

60x120	LPR	K932891LPR01VTE0
20x120	LPR	K932924LPR01VTE0
45x90	LPR	K937253LPR01VTE0
60x60	LPR	K937474LPR01VTE0
30x60	LPR	K937430LPR01VTE0

Bej / Beige

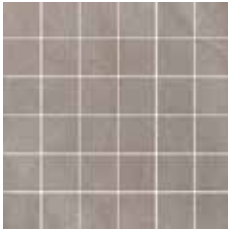

5x5	R10B	K0849308R001VTE0
5x5	LPR	K0849308LPR1VTE0

Kesme Bordür / Cut Border
Bej / Beige



8.5x60	R10	K934291R0001VTE0
8.5x60	LPR	K942945LPR01VTE0

Süpürgelik / Plinth
Bej / Beige

BRITISH STONE

Porselen Karolar / Porcelain Tiles

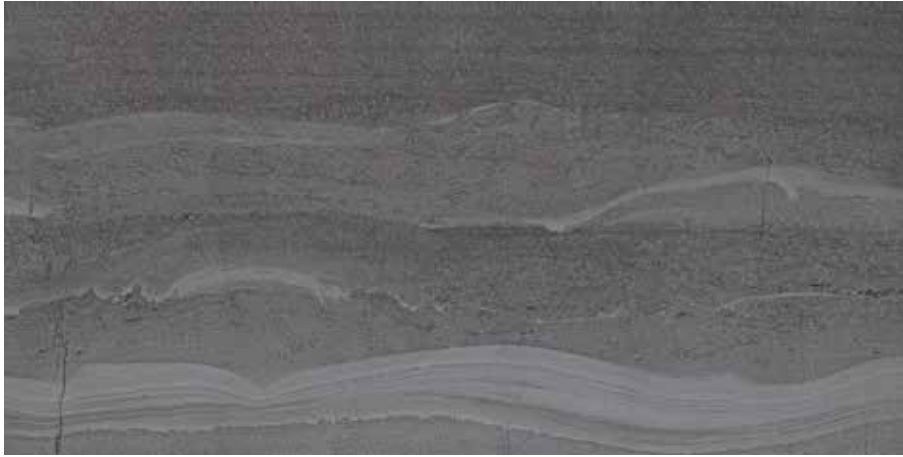

60x120	R10A	K932902R0001VTE0
20x120	R10A	K932935R0001VTE0
60x60	R10A	K937463R0001VTE0
30x60	R10A	K937441R0001VTE0

60x120	LPR	K932902LPR01VTE0
20x120	LPR	K932935LPR01VTE0
45x90	LPR	K943750LPR01VTE0
60x60	LPR	K937463LPR01VTE0
30x60	LPR	K937441LPR01VTE0

Gri / Grey

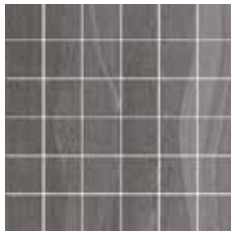

5x5	R10B	K0849418R001VTE0
5x5	LPR	K0849418LPR1VTE0

Kesme Bordür / Cut Border
Gri / Grey



8.5x60	R10	K934302R0001VTE0
8.5x60	LPR	K934302LPR01VTE0

Süpürgelik / Plinth
Gri / Grey



60x120	R10A	K932913R0001VTEO
20x120	R10A	K932946R0001VTEO
60x60	R10A	K937264R0001VTEO
30x60	R10A	K937452R0001VTEO

60x120	LPR	K932913LPR01VTEO
20x120	LPR	K932946LPR01VTEO
45x90	LPR	K944693LPR01VTEO
60x60	LPR	K937264LPR01VTEO
30x60	LPR	K937452LPR01VTEO

Antrasit / Anthracite

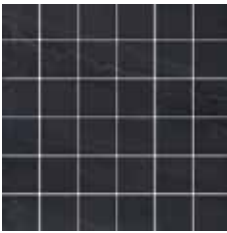

5x5	R10B	K0849528R001VTEO
5x5	LPR	K0849528LPR1VTEO

Kesme Bordür / Cut Border
Antrasit / Anthracite



8.5x60	R10	K934313R0001VTEO
8.5x60	LPR	K934313LPR01VTEO

Süpürgelik / Plinth
Antrasit / Anthracite

BRITISH STONE

Duvar Karoları / Wall Tiles



30x60 Mat/Matt K9407200001VTE0

Açık Bej / Light Beige



30x60 Mat/Matt K94073100001VTE0

Açık Gri / Light Grey

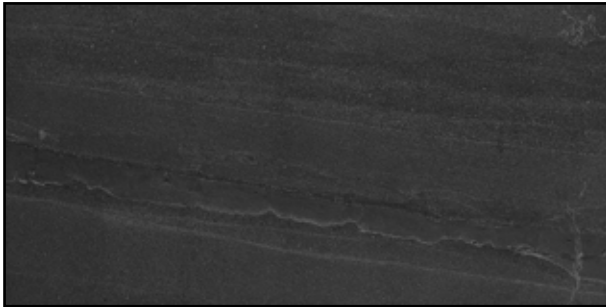

30x60 Mat/Matt K94074200001VTE0

Antrasit / Anthracite



30x60 Mat/Matt K94111400001VTE0

Rölyef / Relief
Açık Bej / Light Beige



30x60 Mat/Matt K94076400001VTE0

Rölyef / Relief
Açık Gri / Light Grey

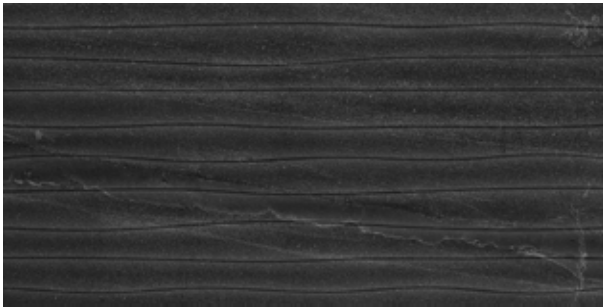

30x60 Mat/Matt K94075300001VTE0

Rölyef / Relief
Antrasit / Anthracite



LOMBARDY



Yer Karoları / Floor Tiles : K946282R0001VTEO 30X60 Lombardy Grej / Greige

Duvar Karoları / Wall Tiles : K94628000001VTEOR 30X60 Lombardy Gri / Grey

PRO

NATURE

LOMBARDY

İtalyan Alplerinin yıllara meydan okuyan güçlü karakterini, kullanıldığı mekânlara taşıyan doğal taş dokulu seramik serisi. Yer ve duvar kaplamalarında yaratıcı kullanımlara izin veren seri, ince damarlı yüzeyiyle hem iç hem de dış mekân kullanımları için modern seçenekler sunuyor.

A natural stone textured ceramic tiles collection, reflecting the everlasting strong character of Italian Alps to the spaces where they are used. The collection offers modern options, for both indoor and outdoor usage with its surface covered with fine veins and allows creative designs on walls and floors.

Porselen Karolar / Porcelain Tiles

Bünye / Body Type

Colorbody Porselen / Colorbody Porcelain

Yüzey Alternatifleri / Surface Alternatives

R9
R10B
LPR

Fon ve Dekor Ebatları / Basic and Decor Tile Sizes

60x60 (R 597x597 mm)
30x60 (R 297x597 mm)
30x60 (297x597 mm)
45x45 (447x447 mm)

Fon ve Dekor Renkleri / Basic and Decor Tile Colors

Krem / Cream
Grej / Greige
Gri / Grey
Antrasit / Anthracite

Kullanım Alanları / Usage Areas

Konut / Residential
Ticari Alan / Commercial

Döşeme Alanları / Tiling Areas

Yer / Floor
Duvar / Wall

Dona Dayanım / Frost Resistance

Var / Available

Baskı Teknolojisi / Printing Technology

ReaLook

Ürün Standardı / Product Standard

EN14411 Group B1a

Dip Notlar / Footnotes

H R



Porselen
Porcelain



Yer Karosu
Floor Tile



Duvar Karosu
Wall Tile



Dış Cephe
Facade



Konut
Residential



Ticari Alan
Commercial



Dona Dayanım
Frost Resistance



Lappato



Mat
Matt



Rektifiyesiz
Non Rectified



Rektifiyeli
Rectified

LOMBARDY

Porselen Karolar / Porcelain Tiles



Krem / Cream

45x45	R9	K94531100001VTE0
30x60	R9	K94530900001VTE0
30x60	R9	K945309R0001VTE0
60x60	R9	K945310R0001VTE0

30x60	LPR	K945309LPR01VTE0
60x60	LPR	K945310LPR01VTE0

30x60	R10B	K94628100001VTE0
30x60	R10B	K946281R0001VTE0
60x60	R10B	K946285R0001VTE0



Grej / Greige

45x45	R9	K94532000001VTE0
30x60	R9	K94531800001VTE0
30x60	R9	K945318R0001VTE0
60x60	R9	K945319R0001VTE0

30x60	LPR	K945318LPR01VTE0
60x60	LPR	K945319LPR01VTE0

30x60	R10B	K94628200001VTE0
30x60	R10B	K946282R0001VTE0
60x60	R10B	K946286R0001VTE0



45x45 R9 K94531700001VTE0
30x60 R9 K94531500001VTE0
30x60 R9 K945315R0001VTE0
60x60 R9 K945316R0001VTE0

30x60 LPR K945315LPR01VTE0
60x60 LPR K945316LPR01VTE0

30x60 R10B K94628000001VTE0
30x60 R10B K946280R0001VTE0
60x60 R10B K946284R0001VTE0

Gri / Grey



45x45 R9 K94531400001VTE0
30x60 R9 K94531200001VTE0
30x60 R9 K945312R0001VTE0
60x60 R9 K945313R0001VTE0

30x60 LPR K945312LPR01VTE0
60x60 LPR K945313LPR01VTE0

30x60 R10B K94627900001VTE0
30x60 R10B K946279R0001VTE0
60x60 R10B K946283R0001VTE0

Antrasit / Anthracite



Krem / Cream
Grej / Greige
Gri / Grey
Antrasit / Anthracite

5x5 R10B K94629940001VTE0
5x5 R10B K94629840001VTE0
5x5 R10B K94629740001VTE0
5x5 R10B K94629640001VTE0

Kalıptan Bordür / Pressed Border
Antrasit / Anthracite



Yer Porselen Karoları / Floor Porcelain Tiles :

K944448R0001VTEO 60x60 Meridien Antrasit / Anthracite

Duvar Porselen Karoları / Wall Porcelain Tiles :

K944450R0001VTEO 60x60 Meridien Gri / Grey

K944448R0001VTEO 60x60 Meridien Antrasit / Anthracite

MERIDIEN



PRO

NATURE

MERIDIEN

Doğal taşı modern bir dokunuşla yeniden yorumlayan seramik serisi. Soğuk ve sakin renklerle modası geçmeyecek, rahatlatıcı bir atmosfer sunuyor. Mermer, ahşap ve beton görünümlü seramik serileriyle birlikte kullanılmak için tasarlandı.

A ceramic series reinterpreting natural stone texture with a modern touch. The collection offers a relaxing atmosphere with timeless cool and calm colors. The series is designed to be used in combination with marble, wood and concrete textured ceramic series.

Porselen Karolar / Porcelain Tiles

Bünye / Body Type

Sırlı porselen / Glazed Porcelain

Yüzey Alternatifleri / Surface Alternatives

R10A

LPR

Fon Ebatları / Basic Tile Sizes

60x60 cm (R 597x597 mm)

30x60 cm (R 297x597 mm)

30x60 cm (297x597 mm)

Fon Renkleri / Basic Tile Colors

Krem / Cream

Gri / Grey

Antrasit / Anthracite

Kullanım Alanları / Usage Areas

Konut / Residential

Döşeme Alanları / Tiling Areas

Yer / Floor

Duvar / Wall

Dona Dayanım / Frost Resistance

Var / Available

Desen Farklılaşması / Shade Variation Classification

V3

Baskı Teknolojisi / Printing Technology

ReaLook

Ürün Standardı / Product Standard

EN14411 Group Bla

Dip Notlar / Footnotes

H R



Porselen
Porcelain



Yer Karosu
Floor Tile



Duvar Karosu
Wall Tile



Dış Cephe
Facade



Konut
Residential



Dona Dayanım
Frost Resistance



Desen Farklılaşması
Shade Variation



Mat
Matt



Lappato



Rektifiyesiz
Non Rectified



Rektifiyeli
Rectified

MERIDIEN

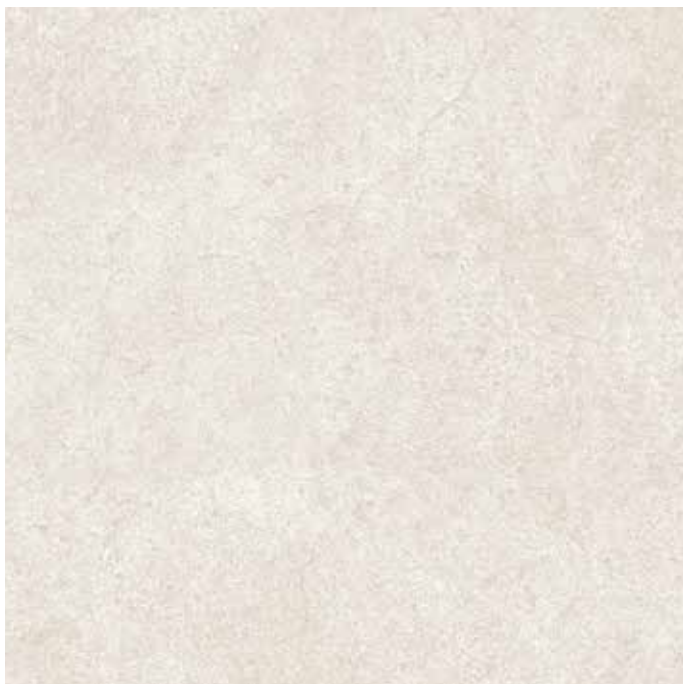

30x60	R10A	K944446R0001VTE0
30x60	R10A	K94444600001VTE0
60x60	R10A	K944449R0001VTE0
60x60	LPR	K944449LPR01VTE0

Krem / Cream

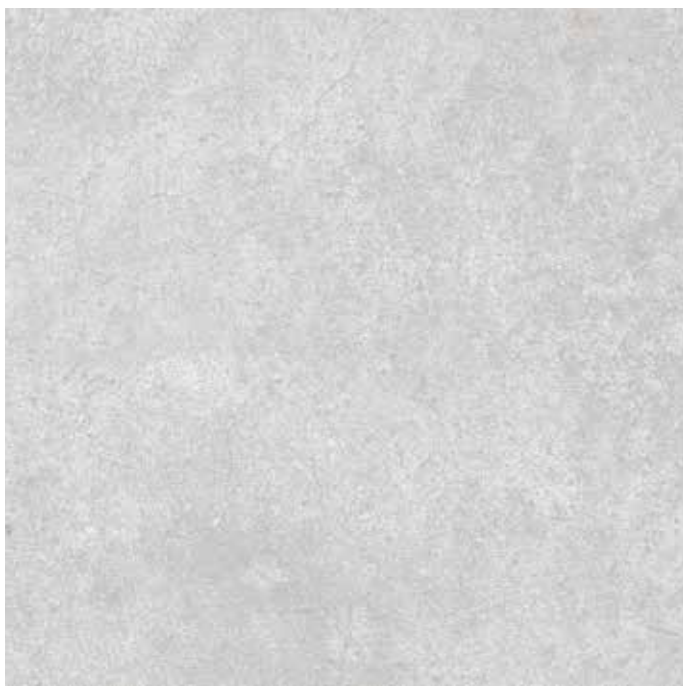

30x60	R10A	K944447R0001VTE0
30x60	R10A	K94444700001VTE0
60x60	R10A	K944450R0001VTE0
60x60	LPR	K944450LPR01VTE0

Gri / Grey



30x60	R10A	K944445R0001VTE0
30x60	R10A	K94444500001VTE0
60x60	R10A	K944448R0001VTE0
60x60	LPR	K944448LPR01VTE0

Antrasit / Anthracite



Krem / Cream	5x5	R10B	K9463024R001VTE0
Gri / Grey	5x5	R10B	K9463004R001VTE0
Antrasit / Anthracite	5x5	R10B	K9463014R001VTE0

Kesme Mozaik / Cut Mosaic
Antrasit / Anthracite



Krem / Cream	5x5	R10B	K94628940001VTE0
Gri / Grey	5x5	R10B	K94628740001VTE0
Antrasit / Anthracite	5x5	R10B	K94628840001VTE0

Kalıptan Bordür / Pressed Border
Antrasit / Anthracite



Yer Karoları / Floor Tiles : K911611R0001VTE0 60x60 Pietra Pienza Bej / Beige

Duvar Karoları / Wall Tiles : K0758638R001VTE0 30x60 Pietra Pienza Kesme Dekor / Cut Decor Bej / Beige
K0759008R001VTE0 1,5x30 Pietra Pienza Kesme Dekor / Cut Decor Bej / Beige

PIETRA PIENZA





PRO

NATURE

PIETRA PIENZA

Modern taş görünümü ve üretim teknolojisi sayesinde sahip olduğu zengin yüzey alternatifleriyle dikkat çeken seramik serisi. Pietra Pienza, doğal renk ve tonlarıyla modern şehir hayatına şıklık katıyor.

A ceramic series distinguished with its modern stone outlook and rich surface alternatives derived from state-of-the-art production technologies. Pietra Pienza adds elegance to modern urban life with its natural colors and tones.

Porselen Karolar / Porcelain Tiles

Bünye / Body Type

Colorbody Porselen / Colorbody Porcelain

Yüzey Alternatifleri / Surface Alternatives

R9
R10B

Fon Ebatları / Basic Tile Sizes

60x60 cm (R 597x597 mm)
30x60 cm (R 297x597 mm)
45x90 cm (447x897mm)

Dekor Ebatları / Decor Sizes

30x60 cm (R 297x597 mm)

Fon Renkleri / Basic Tile Colors

Bej / Beige
Açık Gri / Light Grey
Koyu Gri / Dark Grey
Antrasit / Anthracite

Kullanım Alanları / Usage Areas

Konut / Residential
Ticari Alan / Commercial

Döşeme Alanları / Tiling Areas

Yer / Floor
Duvar / Wall

Dona Dayanım / Frost Resistance

Var / Available

Desen Farklılaşması / Shade Variation Classification

V3

Baskı Teknolojisi / Printing Technology

ReaLook

Ürün Standardı / Product Standard

EN14411 Group B1a

Dip Notlar / Footnotes

H R



Porselen
Porcelain



Yer Karosu
Floor Tile



Duvar Karosu
Wall Tile



Dış Cephe
Facade



Konut
Residential



Ticari Alan
Commercial



Dona Dayanım
Frost Resistance



Desen Farklılaşması
Shade Variation



Mat
Matt



Rektifiyeli
Rectified

PIETRA PIENZA

Porselen Karolar / Porcelain Tiles



Açık Gri / Light Grey

60x60	R9	K909010R0001VTE0
45x90	R9	K913136R0001VTE0
30x60	R9	K909091R0001VTE0
60x60	R10B	K909054R0001VTE0



Koyu Gri / Dark Grey

60x60	R9	K909021R0001VTE0
45x90	R9	K913140R0001VTE0
30x60	R9	K909102R0001VTE0
60x60	R10B	K909065R0001VTE0



Antrasit / Anthracite

60x60	R9	K909032R0001VTE0
45x90	R9	K913151R0001VTE0
30x60	R9	K909113R0001VTE0
60x60	R10B	K909076R0001VTE0



60x60	R9	K909006R0001VTE0
45x90	R9	K913125R0001VTE0
30x60	R9	K909080R0001VTE0
60x60	R10B	K909043R0001VTE0

Bej / Beige



30x60	Bej / Beige	R10B	K0758638R001VTE0
30x60	A. Gri / L. Grey	R10B	K0758748R001VTE0
30x60	K. Gri / D. Grey	R10B	K0758858R001VTE0
30x60	Antrasit / Anthracite	R10B	K0758968R001VTE0

Kesme Dekor / Cut Decor
Bej / Beige



3x3	Bej / Beige	R10B	K0759818R001VTE0
3x3	A. Gri / L. Grey	R10B	K0759928R001VTE0
3x3	K. Gri / D. Grey	R10B	K0760038R001VTE0
3x3	Antrasit / Anthracite	R10B	K0760148R001VTE0

Kesme Dekor / Cut Decor
Bej / Beige



1,5x30	Bej / Beige	R10B	K0759008R001VTE0
1,5x30	A. Gri / L. Grey	R10B	K0759118R001VTE0
1,5x30	K. Gri / D. Grey	R10B	K0759228R001VTE0
1,5x30	Antrasit / Anthracite	R10B	K0759338R001VTE0

Kesme Dekor / Cut Decor
Bej / Beige



Bej / Beige	8,5x60	R9	K909161R0001VTE0
Açık Gri / Light Grey	8,5x60	R9	K909172R0001VTE0
Koyu Gri / Dark Grey	8,5x60	R9	K909183R0001VTE0
Antrasit / Anthracite	8,5x60	R9	K909194R0001VTE0

Süpürgelik / Plinth
Bej / Beige



RAINFOREST



Yer Karoları / Floor Tiles : K914864R0001VTE0 60x60 Rainforest Beyaz / White

Duvar Karoları / Wall Tiles : K914304R0001VTE0 30x60 Rainforest Beyaz / White

PRO

NATURE

RAINFOREST

Tortul katmanlardan oluşan slate taşının porselen ve dijital baskı teknolojisiyle buluşmasından doğan seramik serisi. Rainforest, zengin yüzey alternatifiyle farklı mekânlarda kullanım olanağı yaratıyor.

A ceramic series offering a combination of slate stone comprised of sedimentary layers with porcelain and digital printing technology. Rainforest is ideal for different spaces thanks to its rich surface alternatives.

Porselen Karolar / Porcelain Tiles

Bünye / Body Type

Colorbody Porselen / Colorbody Porcelain

Yüzey Alternatifleri / Surface Alternatives

R9

Fon Ebatları / Basic Tile Sizes

60x60 cm (R 597x597 mm)

30x60 cm (R 297x597 mm)

Fon Renkleri / Basic Tile Colors

Beyaz / White

Antrasit / Anthracite

Kullanım Alanları / Usage Areas

Konut / Residential

Ticari Alan / Commercial

Döşeme Alanları / Tiling Areas

Yer / Floor

Duvar / Wall

Dona Dayanım / Frost Resistance

Var / Available

Desen Farklılaşması /

Shade Variation Classification

V3

Baskı Teknolojisi / Printing Technology

ReaLook

Ürün Standardı / Product Standard

EN14411 Group Bla

Dip Notlar / Footnotes

H R



Porselen
Porcelain



Yer Karosu
Floor Tile



Duvar Karosu
Wall Tile



Dış Cephe
Facade



Konut
Residential



Ticari Alan
Commercial



Dona Dayanım
Frost Resistance



Desen Farklılaşması
Shade Variation



Mat
Matt



Rektifiyeli
Rectified

RAINFOREST

Porselen Karolar / Porcelain Tiles



60x60 R9 K914864R0001VTE0
30x60 R9 K914304R0001VTE0

Beyaz / White



30x60 R9 K0765048R001VTE0

Kesme Dekor / Cut Decor
Beyaz / White



8,5x60 R9 K914890R0001VTE0

Süpürgelik / Plinth
Beyaz / White

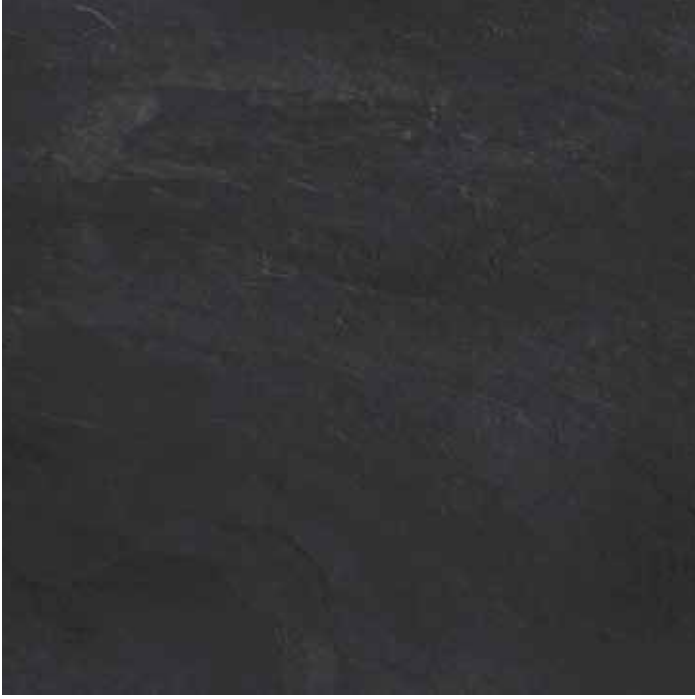

60x60 R9 K914875R0001VTEO
30x60 R9 K914886R0001VTEO

Antrasit / Anthracite

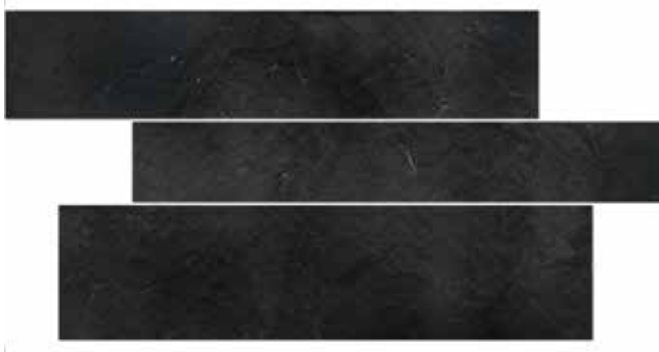

30x60 R9 K0765158R0001VTEO

Kesme Dekor / Cut Decor
Antrasit / Anthracite

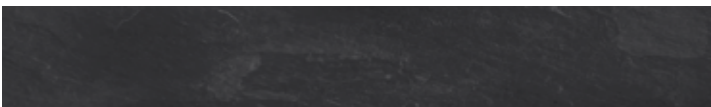

8,5x60 R9 K914901R0001VTEO

Süpürgelik / Plinth
Antrasit / Anthracite



**URBAN
QUARZITE**





PRO

NATURE

URBAN QUARZITE

Doğal quarzite taşının şık tasarımından ilham alan seramik serisi. Bej ve grinin doğal tonları ve farklı yüzey yapıları bir araya gelerek doğal taş görüntüsü yaratıyor. Serinin ince uzun ve kare ebatlarının birlikte kullanım ile modern ve minimalist mekânlar ortaya çıkıyor. Urban Quarzite hem ticari mekânlar hem de konutlar için ideal bir çözüm.

A ceramic series inspired by the stylish and fancy look of quarzite natural stone. The series brings together the natural colors of beige and grey with variable surface patterns reflecting the natural stone look. Urban Quarzite is ideal for both commercial and residential buildings. The series has rectangle and square forms which can be combined to design modern and minimal spaces.

Porselen Karolar / Porcelain Tiles

Bünye / Body Type

Colorbody Porselen / Colorbody Porcelain

Yüzey Alternatifleri / Surface Alternatives

R10A

Fon Ebatları / Basic Tile Sizes

60x120 cm (R 597x1197 mm)

60x60 cm (R 597x597 mm)

60x60 cm (R 595x595 mm) 20 mm

Fon Renkleri / Basic Tile Colors

Beyaz / White

Bej / Beige

Gri / Grey

Antrasit / Anthracite

Koyu Bej / Dark Beige

Kullanım Alanları / Usage Areas

Konut / Residential

Ticari Alan / Commercial

Döşeme Alanları / Tiling Areas

Yer / Floor

Duvar / Wall

Dona Dayanım / Frost Resistance

Var / Available

Desen Farklılaşması /

Shade Variation Classification

V4

Baskı Teknolojisi / Printing Technology

ReaLook

Ürün Standardı / Product Standard

EN14411 Group B1a

Dip Notlar / Footnotes

B R



Porselen
Porcelain



Yer Karosu
Floor Tile



Duvar Karosu
Wall Tile



Dış Cephe
Facade



Konut
Residential



Ticari Alan
Commercial



Havuz Çevresi
Pool Surrounding



Dona Dayanım
Frost Resistance



Desen Farklılaşması
Shade Variation



Mat
Matt



Rektifiyeli
Rectified



20 mm
60x60

URBAN QUARZITE

Porselen Karolar / Porcelain Tiles



Beyaz / White

60x60	R11	K943787R0001VTEO	20mm
60x120	R10A	K943359R0001VTEO	
60x60	R10A	K943469R0001VTEO	



Bej / Beige

60x60	R11	K943788R0001VTEO	20mm
60x120	R10A	K943360R0001VTEO	
60x60	R10A	K943470R0001VTEO	



Koyu Bej / Dark Beige

60x120	R10A	K946681R0001VTEO	
60x60	R10A	K946997R0001VTEO	



60x60 R11 K943789R0001VTE0 20mm

60x120 R10A K943361R0001VTE0
60x60 R10A K943471R0001VTE0

Gri / Grey



60x60 R11 K943790R0001VTE0 20mm

60x120 R10A K943362R0001VTE0
60x60 R10A K943473R0001VTE0

Antrasit / Anthracite



QUARZITE



PRO

NATURE

QUARZITE

Quarzite taşının modern yorumuyla mekanlara pozitif enerji katan seri, colorbody porselen çağa uygun tasarımlarıyla her türlü zevke hitap ediyor. Açık ve koyu gri, bej ve antrasit renkleriyle hem iç hem de dış mekânlar için ideal bir çözüm sunuyor. Doğal taşların gelişigüzel hareleriyle akıcı bir yüzey yaratan seri 45x90 ve 30x60 cm ölçülerine sahip.

Adding positive energy to spaces with the modern interpretation of quartzite stone, the series addresses individual tastes with contemporary designs. Light and dark grey, beige and anthracite colors offer an ideal solution for both inner and outer spaces. The series creates an active surface with the random waves of natural stones in 45x90 and 30x60 cm size options.

Porselen Karolar / Porcelain Tiles

Bünye / Body Type

Colorbody Porselen / Colorbody Porcelain

Yüzey Alternatifleri / Surface Alternatives

R9

Fon Ebatları / Basic Tile Sizes

30x60 cm (297x597 mm)

Fon Renkleri / Basic Tile Colors

Bej / Beige

Açık Gri / Light Grey

Koyu Gri / Dark Grey

Antrasit / Anthracite

Kullanım Alanları / Usage Areas

Konut / Residential

Ticari Alan / Commercial

Döşeme Alanları / Tiling Areas

Yer / Floor

Duvar / Wall

Dona Dayanım / Frost Resistance

Var / Available

Desen Farklılaşması / Shade Variation Classification

V2

Baskı Teknolojisi / Printing Technology

ReaLook

Ürün Standardı / Product Standard

EN14411 Group Bla

Dip Notlar / Footnotes

H R



Porselen
Porcelain



Yer Karosu
Floor Tile



Duvar Karosu
Wall Tile



Dış Cephe
Facade



Konut
Residential



Ticari Alan
Commercial



Dona Dayanım
Frost Resistance



Desen Farklılaşması
Shade Variation



Mat
Matt



Rektifiyesiz
Non Rectified

QUARZITE

Porselen Karolar / Porcelain Tiles



30x60 R9

K86443200001VTE0

Açık gri / Light grey



30x60 R9

K86681200001VTE0

Koyu gri / Dark grey



30x60 R9

K86442100001VTE0

Bej / Beige



30x60 R9

K86901500001VTE0

Antrasit / Anthracite

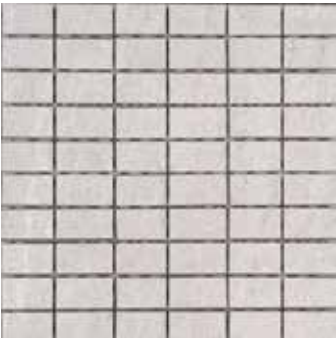

Bej / Beige	2,5x5	K05974380001VTE0
Açık gri / Light Grey	2,5x5	K05975480001VTE0
Koyu gri / Dark Grey	2,5x5	K05976580001VTE0
Antrasit / Anthracite	2,5x5	K05977680001VTE0

Kesme Bordür / Cut Border
Açık gri / Light grey



Duvar Karoları / Wall Tiles : K823171R0001VTEO 30x60 Ararat Gri / Grey
K822751R0001VTEO 30x60 Ararat Koyu Gri / Dark Grey

ARARAT



PRO

NATURE

ARARAT

Belçika'nın ünlü doğal taşı Blue Stone'u trend renklerle yeniden yorumlayan seramik serisi. Klasikle moderniyi harmanlayarak benzersiz bir görsel zenginlik yaratıyor. Doğal görünümlü lappato ve mat yüzey alternatifleriyle tüm yaşam alanları ve ticari mekânlar için mükemmel bir alternatif oluşturuyor. Ararat colorbody porselen karolar farklı renk ve ebat seçenekleriyle geniş bir yelpazeye sahip.

A re-interpretation of famous Belgian Blue Stone with trendy colors, Ararat series creates a matchless visual richness by blending the classic with modernism. It is ideal for all living and commercial spaces with natural looking lappato and matt surface alternatives. Ararat colorbody porcelain tiles have a wide range of alternatives with different colors and sizes.

Porselen Karolar / Porcelain Tiles

Bünye / Body Type

Colorbody Porselen / Colorbody Porcelain

Yüzey Alternatifleri / Surface Alternatives

LPR

Mat / Matt

Fon Ebatları / Basic Tile Sizes

60x60 cm (R 597x597 mm)

30x60 cm (R 297x597 mm)

30x60 cm (297x597 mm)

Fon Renkleri / Basic Tile Colors

Fildişi / Ivory

Gri / Grey

Koyu Gri / Dark Grey

Kullanım Alanları / Usage Areas

Konut / Residential

Ticari Alan / Commercial

Döşeme Alanları / Tiling Areas

Yer / Floor

Duvar / Wall

Dona Dayanım / Frost Resistance

Var / Available

Desen Farklılaşması /

Shade Variation Classification

V2

Ürün Standardı / Product Standard

EN14411 Group B1a

Dip Notlar / Footnotes

H R



Porselen
Porcelain



Yer Karosu
Floor Tile



Duvar Karosu
Wall Tile



Dış Cephe
Facade



Konut
Residential



Ticari Alan
Commercial



Dona Dayanım
Frost Resistance



Desen Farklılaşması
Shade Variation



Mat
Matt



Lappato



Rektifiyeli
Rectified



Rektifiyesiz
Non Rectified

ARARAT

Porselen Karolar / Porcelain Tiles



60x60	Mat/Matt	K886590R0001VTE0
30x60	Mat/Matt	K823156R0001VTE0
30x60	Mat/Matt	K82315600001VTE0

60x60	LPR	K886590LPR01VTE0
30x60	LPR	K823156LPR01VTE0

Fildişi / Ivory



60x60	Mat/Matt	K886612R0001VTE0
30x60	Mat/Matt	K823171R0001VTE0
30x60	Mat/Matt	K82317100001VTE0

60x60	LPR	K886612LPR01VTE0
30x60	LPR	K823171LPR01VTE0

Gri / Grey



60x60	Mat/Matt	K886623R0001VTE0
30x60	Mat/Matt	K822751R0001VTE0
30x60	Mat/Matt	K82275100001VTE0
60x60	LPR	K886623LPR01VTE0
30x60	LPR	K822751LPR01VTE0

Koyu Gri / Dark Grey

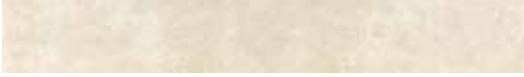

8,5x60	Mat/Matt	K830936R0001VTE0
--------	----------	------------------

Süpürgelik / Plinth
Fildişi / Ivory



8,5x60	Mat/Matt	K842350R0001VTE0
--------	----------	------------------

Süpürgelik / Plinth
Gri / Grey



8,5x60	Mat/Matt	K830962R0001VTE0
--------	----------	------------------

Süpürgelik / Plinth
Koyu Gri / Dark Grey



Yer Karoları / Floor Tiles : K94398500001VTEo 45x45 Stoneway Açık Gri / Light Grey
K94398300001VTEo 45x45 Stoneway Kahve / Brown

STONEWAY



PRO

NATURE

STONEWAY

Stoneway porselen karo serisinde, renklerin sakinleřtirici etkisiyle doęal tařın modası gemeyecek řıklıęı birleřiyor. Sade ve zamansız mekânlar tasarlamak için mükemmel bir seim olan Stoneway; Limestar bařta olmak üzere birok duvar karo serisiyle ideal bir uyum oluřturuyor.

A ceramic series combining the relaxing effect of colors and elegance of natural stone that will never be out of fashion. A perfect option for designing plain and timeless spaces, Stoneway is compatible with many wall tile series, starting with Limestar.

Porselen Karolar / Porcelain Tiles

Bünye / Body Type

Sırlı Porselen / Glazed Porcelain

Yüzey Alternatifleri / Surface Alternatives

R9

Fon Ebatları / Basic Tile Sizes

45x45 cm (447x447 mm)

Fon Renkleri / Basic Tile Colors

Krem / Cream

Bej / Beige

Taba / Tobacco

Aık Gri / Light Grey

Kahve / Brown

Kullanım Alanları / Usage Areas

Konut / Residential

Döřeme Alanları / Tiling Areas

Duvar / Wall

Yer / Floor

Dona Dayanım / Frost Resistance

Var / Available

Desen Farklılařması /

Shade Variation Classification

V2

Baskı Teknolojisi / Printing Technology

ReaLook

Ürün Standardı / Product Standard

EN14411 Group Bla

Dip Notlar / Footnotes

H R



Porselen
Porcelain



Yer Karosu
Floor Tile



Duvar Karosu
Wall Tile



Dıř Ceph
Facade



Konut
Residential



Ticari Alan
Commercial



Dona Dayanım
Frost Resistance



Desen Farklılařması
Shade Variation



Mat
Matt



Rektifiyesiz
Non Rectified

STONEWAY

Porselen Karolar / Porcelain Tiles



45x45 R9 K94393800001VTE0

Krem / Cream



45x45 R9 K94393900001VTE0

Bej / Beige



45x45 R9 K94394100001VTE0

Taba / Tobacco



45x45 R9 K94398500001VTE0

Açık Gri / Light Grey



45x45 R9 K94398300001VTE0

Kahve / Brown



STIX



Yer Porselen Karoları / Floor Porcelain Tiles : K925353R0001VTE0 20x120 Samba Bej / Beige

Duvar Porselen Karoları / Wall Porcelain Tiles : K94498800001VTE0 30x60 Stix Siyah / Black

K94499000001VTE0 30x60 Stix Çizgi Dekor Siyah / Lines Decor Black

K94499300001VTE0 30x60 Stix Scored Mix Dekor Siyah / Scored Mix Decor Black

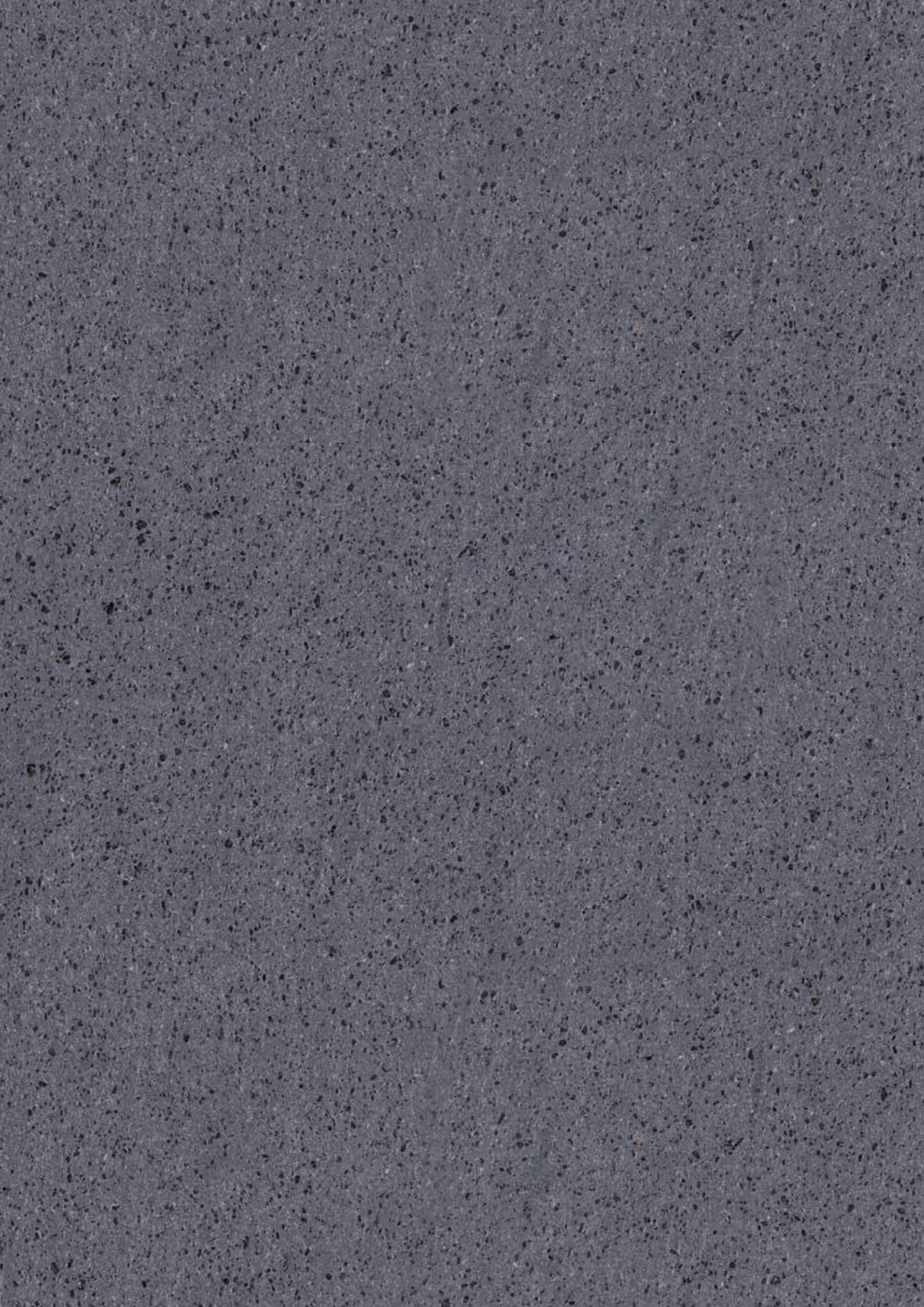

PRO

NATURE

STIX

Siyahın beyaz tonları ile buluştuğu doğal taş görünümlü seramik serisi. Tribal desenleri, el yapımı seramiğin üç boyutlu estetiği, volkanik taşların ve kireçtaşının doğal güzelliği ve platin dekorlarının kontrastı ile modası hiç geçmeyecek yaşam alanları tasarlamana imkân sağlıyor.

Natural stone looking ceramic series where black meets white tones. It allows designers to create fashionable living spaces, thanks to its tribal patterns, 3D aesthetic of hand-made ceramic, natural beauty of volcanic rocks and limestone enriched with the contrast of platinum decors.

Duvar Karoları / Wall Tiles

Fon Ebatları / Basic Tile Sizes
30x60 cm (298X598 mm)

Dekor Ebatları / Decor Sizes
30x60 cm (298X598 mm)

Yüzey Alternatifleri / Surface Alternatives
Mat / Matt

**Fon ve Dekor Renkleri /
Basic Tile and Decor Colors**
Beyaz / White
Siyah / Black

Kullanım Alanları / Usage Areas
Konut / Residential

Döşeme Alanları / Tiling Areas
Duvar / Wall

**Uyumlu Yer Karoları /
Compatible Floor Tiles**
Meridien
Samba

**Desen Farklılaşması /
Shade Variation Classification**
V1

Dona Dayanım / Frost Resistance
Yok / Not Available

Baskı Teknolojisi / Printing Technology
ReaLook

Ürün Standardı / Product Standard
EN14411 Group BIII

Dip Notlar / Footnotes

H B



Duvar Karosu
Wall Tile



Ödüllü
Award Winning



Konut
Residential



Mat
Matt



Rektifiyesiz
Non Rectified



V1
Desen Farklılaşması
Shade Variation



DECOR
PRINTING



STIX

Duvar Karoları / Wall Tiles



30x60 Mat / Matt K94498800001VTE0

Siyah / Black



30x60 Mat / Matt K94499000001VTE0

Çizgi Dekor / Lines Decor
Siyah / Black

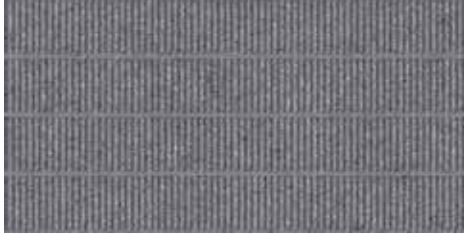

30x60 Mat / Matt K94499200001VTE0

Kanallı Çizgi Dekor / H. Lines Decor
Siyah / Black



30x60 Mat / Matt K94499500001VTE0

Platin Dekor / Platin Decor
Siyah / Black



30x60 Mat / Matt K94499300001VTE0

Scored Mix Decor (*)
Siyah / Black



30x60 Mat / Matt K94498700001VTEO

Beyaz / White



30x60 Mat / Matt K94498900001VTEO

Çizgi Dekor / Lines Decor
Beyaz / White

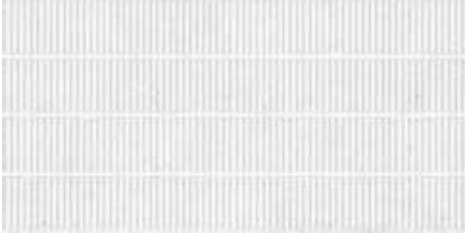

30x60 Mat / Matt K94499100001VTEO

Kanallı Çizgi Dekor / H. Lines Decor
Beyaz / White



30x60 Mat / Matt K94499400001VTEO

Platin Dekor / Platin Decor
Beyaz / White



30x60 Mat / Matt K94853800001VTEO

Scored Mix Decor (*)
Beyaz / White

(*) VitrA, dekor olarak kullanılan ürünlerinde görsel çeşitlilik sağlamak amacıyla aynı kutu içinden çıkan ürünleri aralarında küçük desen farkları olacak şekilde paketlemektedir. Bu serideki kanallı mix dekorlarda 12 farklı desen tasarımı çalışılmıştır.

(*) VitrA, bundles decors in such a way that there will be small pattern differences between them in every box to assure visual diversity. Stix scored mix decors have 12 different pattern design.



Yer Karoları / Floor Tiles : K94398500001VTE0 45x45 Stoneway Açık Gri / Light Grey

Duvar Karoları / Wall Tiles : K94380500001VTE0 30x60 Limestar Açık Gri / Light Grey
K94381700001VTE0 30x60 Limestar Rölyef Dekor 2 / Relief Decor 2 Gri / Grey

LIMESTAR



PRO

NATURE

LIMESTAR

İç dekorasyonda bütün zamanların gözdesi kireçtaşının yeni bir yorumu olan seramik serisi. Doğal taşın modern tasarımlı mekânlar için yeniden yorumlandığı bu şık seride orijinal krem tonlarının yanı sıra gri renk de bulunuyor. Serinin fonları ve çizgili rölyef dekorları modern yaşam alanları yaratmak için ideal.

A ceramic series reinterpreting the ever-popular limestone. This elegant series in which natural stone is reinterpreted for modern designed spaces, offers original cream tones in addition to grey colour option. Basic tiles and linear relief decors of the series are ideal for creating modern living spaces.

Duvar Karoları / Wall Tiles

Yüzeysel Alternatifleri / Surface Alternatives
Mat / Matt

Fon ve Dekor Ebatları / Basic Tile and Decor Sizes
30x60 cm (298x598 mm)

Fon Renkleri / Basic Tile Colors
Açık Krem / Light Cream
Açık Gri / Light Grey

Dekor Renkleri / Decor Colors
Krem / Cream
Gri / Grey

Uyumlu Yer Karoları / Compatible Floor Tiles
Stoneway

Kullanım Alanları / Usage Areas
Konut / Residential

Döşeme Alanları / Tiling Areas
Duvar / Wall

Dona Dayanım / Frost Resistance
Yok / Not Available

Desen Farklılaşması / Shade Variation Classification
V1

Baskı Teknolojisi / Printing Technology
ReaLook

Ürün Standardı / Product Standard
EN14411 Group BIII



Duvar Karosu
Wall Tile



Konut
Residential



Desen Farklılaşması
Shade Variation



Mat
Matt



Rektifiyesiz
Non Rectified

LIMESTAR

Duvar Karoları / Wall Tiles



30x60 Mat / Matt K94380200001VTE0

Açık Krem / Light Cream



30x60 Mat / Matt K94381200001VTE0

Rölyef Dekor 2 / Relief Decor 2
Krem / Cream

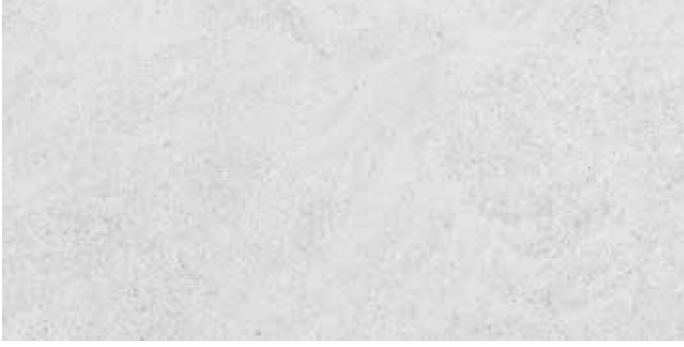

30x60 Mat / Matt K94380500001VTE0

Açık Gri / Light Grey

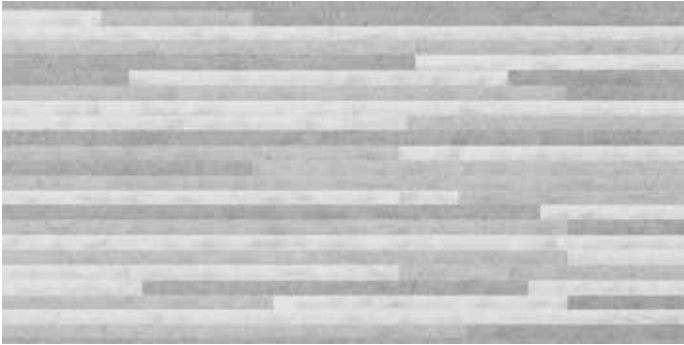

30x60 Mat / Matt K94381700001VTE0

Rölyef Dekor 2 / Relief Decor 2
Gri / Grey



Yer Karoları / Floor Tiles : K94545500001VTEo 45X45 Textone Açık Gri / Light Grey

Duvar Karoları / Floor Tiles : K94544200001VTEo 25x40 Textone Gri / Grey
K94544300001VTEo 25x40 Textone Açık Gri / Light Grey

TEXTONE



PRO

NATURE

TEXTONE

Kumaş dokusunun modern yorumuyla moda renkleri birleştiren seramik serisi, ahenkli renkler ve doku seçenekleriyle duvar ve yer karolarının çarpıcı kombinasyonlarını sunuyor.

A ceramic series that combines modern interpretation of fabric textures with trendy colors. Textone offers harmonious color and texture options of wall and floor tiles in impressive combinations.

Duvar Karoları / Wall Tiles

Fon Ebatları / Basic Tile Sizes

25x40 cm

Yüzey Alternatifleri / Surface Alternatives

Mat / Matt

Fon Renkleri / Basic Tile Colors

Bej / Beige

Krem / Cream

Açık Gri / Light Grey

Gri / Grey

Kullanım Alanları / Usage Areas

Konut / Residential

Döşeme Alanları / Tiling Areas

Duvar / Wall

Dona Dayanım / Frost Resistance

Yok / Not Available

Baskı Teknolojisi / Printing Technology

ReaLook

Ürün Standardı / Product Standard

EN14411 Group BIII



Duvar Karosu
Wall Tile



Konut
Residential



Mat
Matt



Rektifiyesiz
Non Rectified

Porselen Karolar / Porcelain Tiles

Bünye / Body Type

Sırlı Porselen / Glazed Porcelain

Yüzey Alternatifleri / Surface Alternatives

Mat / Matt

Fon Ebatları / Basic Tile Sizes

45x45 cm (447x447 mm)

Fon Renkleri / Basic Tile Colors

Bej / Beige

Krem / Cream

Açık Gri / Light Grey

Gri / Grey

Kullanım Alanları / Usage Areas

Konut / Residential

Döşeme Alanları / Tiling Areas

Yer / Floor

Dona Dayanım / Frost Resistance

Var / Available

Desen Farklılaşması /

Shade Variation Classification

V3

Baskı Teknolojisi / Printing Technology

ReaLook

Ürün Standardı / Product Standard

EN14411 Group Bla (Glazed Porcelain)



Porselen
Porcelain



Yer Karosu
Floor Tile



Konut
Residential



Dona Dayanım
Frost Resistance



V3
Desen Farklılaşması
Shade Variation



Mat
Matt



Rektifiyesiz
Non Rectified

TEXTONE

Duvar Karoları / Wall Tiles



25x40 Mat / Matt K94544100001VTE0

Krem / Cream

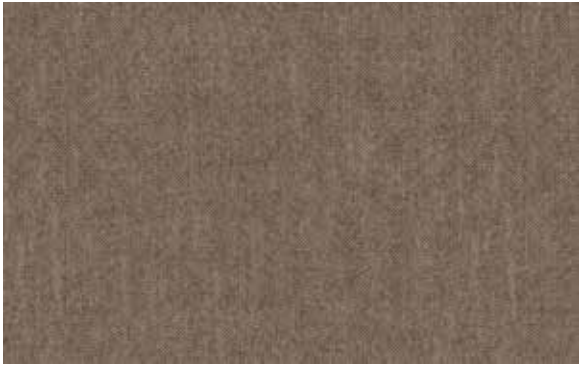

25x40 Mat / Matt K94544000001VTE0

Bej / Beige



25x40 Mat / Matt K94544300001VTE0

Açık Gri / Light Grey



25x40 Mat / Matt K94544200001VTE0

Gri / Grey

Porselen Karolar / Porcelain Tiles



45x45 Mat / Matt K94545500001VTE0

Açık Gri / Light Grey

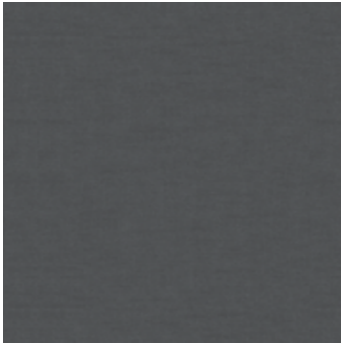

45x45 Mat / Matt K94545400001VTE0

Gri / Grey



45x45 Mat / Matt K94545300001VTE0

Krem / Cream



45x45 Mat / Matt K94545200001VTE0

Bej / Beige



QUARZ

Yer Karoları / Floor Tiles : K94543600001VTE0 45x45 Quarz Açık Gri / Light Grey

Duvar Karoları / Wall Tiles : K94542400001VTE0 25x40 Quarz Açık Gri / Light Grey
K94542700001VTE0 25x40 Quarz Açık Gri Dalga Dekor / Wave Decor Light Grey

PRO

NATURE

QUARZ

Açık tonları ve etkileyici doğal taş görünümüyle cross-cut traverten taşı modern bir tasarım çizgisinde yorumlayan seramik serisi. Serinin ürün yelpazesi, doğal akışkan rigato rölyefleri, uyumlu yer karoları ve tamamlayıcı parçaları kapsıyor.

A modern interpretation of cross-cut travertine stone, in light shades and impressive natural stone look.

The product range includes natural fluid rigato reliefs, compatible floor tiles and bullnose parts.

Duvar Karoları / Wall Tiles

Fon ve Dekor Ebatları / Basic Tile and Decor Sizes

25x40 cm
7,5x25 cm

Yüzey Alternatifleri / Surface Alternatives

Mat / Matt

Fon ve Dekor Renkleri / Basic Tile and Decor Colors

Kum Beji / Sand
Açık Gri / Light Grey
Gri / Grey
Vizon / Mink

Kullanım Alanları / Usage Areas

Konut / Residential

Döşeme Alanları / Tiling Areas

Duvar / Wall

Dona Dayanım / Frost Resistance

Yok / Not Available

Desen Farklılaşması / Shade Variation Classification

V3

Baskı Teknolojisi / Printing Technology

ReaLook

Ürün Standardı / Product Standard

EN14411 Group BIII



Duvar Karosu
Wall Tile



Konut
Residential



Mat
Matt



Rektifiyesiz
Non Rectified



V³
Desen Farklılaşması
Shade Variation

Porselen Karolar / Porcelain Tiles

Bünye / Body Type

Sırlı Porselen / Glazed Porcelain

Yüzey Alternatifleri / Surface Alternatives

Mat / Matt

Fon Ebatları / Basic Tile Sizes

45x45 cm (447x447 mm)

Fon Renkleri / Basic Tile Colors

Kum Beji / Sand
Açık Gri / Light Grey
Gri / Grey
Vizon / Mink

Kullanım Alanları / Usage Areas

Konut / Residential

Döşeme Alanları / Tiling Areas

Yer / Floor

Dona Dayanım / Frost Resistance

Var / Available

Desen Farklılaşması /

Shade Variation Classification

V3

Baskı Teknolojisi / Printing Technology

ReaLook

Ürün Standardı / Product Standard

EN14411 Group Bla (Glazed Porcelain)



Porselen
Porcelain



Yer Karosu
Floor Tile



Konut
Residential



Dona Dayanım
Frost Resistance



V3
Desen Farklılaşması
Shade Variation



Mat
Matt



Rektifiyesiz
Non Rectified

QUARZ

Duvar Karoları / Wall Floors



25x40 Mat / Matt K94542300001VTE0

Kum Beji / Sand



25x40 Mat / Matt K94542400001VTE0

Açık Gri / Light Grey



25x40 Mat / Matt K94542500001VTE0

Gri / Grey



25x40 Mat / Matt K94548000001VTE0

Vizon / Mink



25x40 Mat / Matt K94542600001VTE0

Kum Beji / Sand
Dalga Dekor / Wave Decor



25x40 Mat / Matt K94542700001VTE0

Açık Gri / Light Grey
Dalga Dekor / Wave Decor



25x40 Mat / Matt K94542800001VTE0

Gri / Grey
Dalga Dekor / Wave Decor



25x40 Mat / Matt K94548100001VTE0

Vizon / Mink
Dalga Dekor / Wave Decor

QUARZ

Porselen Karolar / Porcelain Tiles



45x45 Mat / Matt K94543500001VTE0

Kum Beji / Sand



45x45 Mat / Matt K94543600001VTE0

Açık Gri / Light Grey



45x45 Mat / Matt K94543700001VTE0

Gri / Grey



45x45 Mat / Matt K94548400001VTE0

Vizon / Mink



PANGA



Yer Karoları / Floor Tiles : K84633600001VTE0 33x33 Panga Açık Gri / Light Grey

Duvar Karoları / Wall Tiles : K88247000001VTE0 25x40 Panga Beyaz / White

PRO

NATURE

PANGA

Ahşabın rahatlatan doğal dokusunu mekânlara taşıyan Panga serisi, dikkat çekici renkleriyle kapladığı her yerde samimiyet duygusu yaratıyor. Modern görünümü ile yaşam alanlarına sıcak bir hava katan seri açık gri, antrasit, beyaz, bej ve kahve renkleriyle öne çıkıyor.

Redesigning spaces with the comforting natural touch of wood, Panga series is distinguished with the sense of warmth it creates with its attractive color options. The series makes the living spaces more welcoming thanks to its modern outlook and light grey, anthracite, white, beige, brown color options.

Duvar Karoları / Wall Tiles

**Fon ve Dekor Ebatları /
Basic Tile and Decor Sizes**
25x40 cm

Yüzey Alternatifleri / Surface Alternatives
Mat / Matt

**Fon ve Dekor Renkleri /
Basic Tile and Decor Colors**
Beyaz / White
Açık Gri / Light Grey

Kullanım Alanları / Usage Areas
Konut / Residential

Döşeme Alanları / Tiling Areas
Duvar / Wall

Dona Dayanım / Frost Resistance
Yok / Not Available

**Desen Farklılaşması /
Shade Variation Classification**
V1

Baskı Teknolojisi / Printing Technology
Rotocolor

Ürün Standardı / Product Standard
EN14411 Group BIII



Duvar Karosu
Wall Tile



Konut
Residential



Mat
Matt



Rektifiyesiz
Non Rectified



V1
Desen Farklılaşması
Shade Variation

Yer Karoları / Floor Tiles

Bünye / Body Type

Seramik Yer Karoları / Ceramic Floor Tiles

Yüzey Alternatifleri / Surface Alternatives

Mat / Matt

Fon Ebatları / Basic Tile Sizes

33x33 cm

Fon Renkleri / Basic Tile Colors

Beyaz / White

Açık Gri / Light Grey

Kullanım Alanları / Usage Areas

Konut / Residential

Döşeme Alanları / Tiling Areas

Yer / Floor

Dona Dayanım / Frost Resistance

Var / Available

Desen Farklılaşması /

Shade Variation Classification

V1

Baskı Teknolojisi / Printing Technology

Rotocolor

Ürün Standardı / Product Standard

EN14411 Group B1b



Yer Karosu
Floor Tile



Dona Dayanım
Frost Resistance



Konut
Residential



Mat
Matt



Rektifiyesiz
Non Rectified



Desen Farklılaşması
Shade Variation

PANGA

Duvar Karoları / Wall Floors



25x40 Mat / Matt K88247000001VTE0

Beyaz / White



25x40 Mat / Matt K88245500001VTE0

Açık Gri / Light Grey

Seramik Yer Karoları / Ceramic Floor Tiles



33x33 Mat / Matt K84629200001VTE0

Beyaz / White



33x33 Mat / Matt K84633600001VTE0

Açık Gri / Light Grey



PIETRA PIENZA - S



Yer Karoları / Floor Tiles : K92274100001VTE0 M45x45 Pietra Pienza - S Anrasit / Anthracite

Duvar Karoları / Wall Tiles : K94495400001VTE0 25x40 Pietra Pienza - S Anrasit Çizgi Dekor / Anthracite Line Decor
K94495500001VTE0 25x40 Pietra Pienza - S Anrasit / Anthracite

PRO

NATURE

PIETRA PIENZA - S

İleri üretim teknolojisi sayesinde sahip olduğu zengin yüzey görüntüsüyle dikkat çeken modern taş görünümlü seramik serisi, modern şehir hayatına doğal renkleri ve tonlarıyla zarafet katıyor.

A ceramic series distinguished with its modern stone outlook and rich surface alternatives derived from state-of-the-art production technologies. Pietra Pienza adds elegance to modern urban life with its natural colors and tones.

Duvar Karoları / Wall Tiles

**Fon ve Dekor Ebatları /
Basic Tile and Decor Sizes**
25x40 cm

Yüzey Alternatifleri / Surface Alternatives
Mat / Matt

Fon ve Dekor Renkleri / Basic Tile and Decor Colors

Bej / Beige
Açık Gri / Light Grey
Koyu Gri / Dark Grey
Antrasit / Anthracite

Kullanım Alanları / Usage Areas
Konut / Residential

Döşeme Alanları / Tiling Areas
Duvar / Wall

Dona Dayanım / Frost Resistance
Yok / Not Available

**Desen Farklılaşması /
Shade Variation Classification**
V3

Baskı Teknolojisi / Printing Technology
ReaLook

Ürün Standardı / Product Standard
EN14411 Group BIII

Duvar Karosu
Wall Tile

Konut
Residential

Mat
Matt

Rektifiyesiz
Non Rectified

Desen Farklılaşması
Shade Variation

Porselen Karolar / Porcelain Tiles

Bünye / Body Type

Sırlı Porselen / Glazed Porcelain

Yüzey Alternatifleri / Surface Alternatives

Mat / Matt

Fon Ebatları / Basic Tile Sizes

45x45 cm (447x447 mm)

Fon Renkleri / Basic Tile Colors

Bej / Beige

Açık Gri / Light Grey

Koyu Gri / Dark Grey

Antrasit / Anthracite

Kullanım Alanları / Usage Areas

Konut / Residential

Döşeme Alanları / Tiling Areas

Yer / Floor

Dona Dayanım / Frost Resistance

Var / Available

Desen Farklılaşması /

Shade Variation Classification

V3

Baskı Teknolojisi / Printing Technology

ReaLook

Ürün Standardı / Product Standard

EN14411 Group B1a



Porselen
Porcelain



Yer Karosu
Floor Tile



Konut
Residential



Dona Dayanım
Frost Resistance



V3
Desen Farklılaşması
Shade Variation



Mat
Matt



Rektifiyesiz
Non Rectified

PIETRA PIENZA - S

Duvar Karoları / Wall Tiles



25x40 Mat / Matt K94495800001VTE0

Bej / Beige



25x40 Mat / Matt K94495700001VTE0

Bej / Beige
Çizgi Dekor / Line Decor



25x40 Mat / Matt K94495200001VTE0

Açık Gr / Light Grey



25x40 Mat / Matt K94495100001VTE0

Açık Gr / Light Grey
Çizgi Dekor / Line Decor

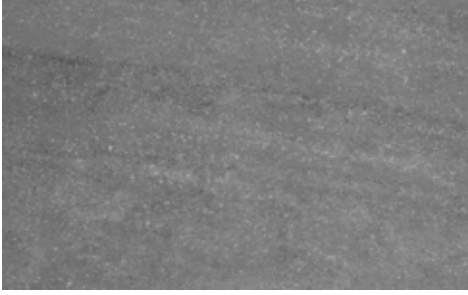

25x40 Mat / Matt K94496100001VTEO

Koyu Gri / Dark Grey

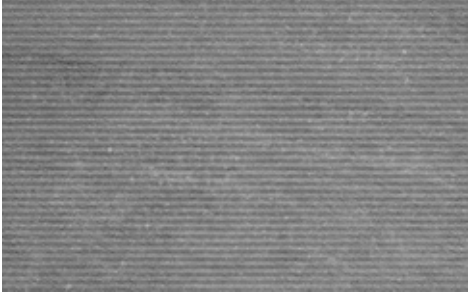

25x40 Mat / Matt K94496000001VTEO

Koyu Gri / Dark Grey
Çizgi Dekor / Line Decor



25x40 Mat / Matt K94495500001VTEO

Antrasit / Anthracite



25x40 Mat / Matt K94495400001VTEO

Antrasit / Anthracite
Çizgi Dekor / Line Decor

PIETRA PIENZA - S

Porselen Karolar / Porcelain Tiles



45x45 Mat / Matt

K92271500001VTEO

Bej / Beige



45x45 Mat / Matt

K92272600001VTEO

Açık Gr / Light Grey



45x45 Mat / Matt

K92273000001VTEO

Koyu Gri / Dark Grey



45x45 Mat / Matt

K92274100001VTEO

Antrasit / Anthracite



WOOD OBSESSION

AHŞAP TUTKUSU

Ahşap, dokusuyla yakınlaştıran, canlılığı ile hayat katan, doğanın soluğunu taşıyan tutkunuz. Yaşayan her alana kattığı sıcaklıkla ruhunuzu dinlendiriyor.

The wood is your obsession making spaces warmer with its texture, animated with its spirit and breathing with its nature. It rests your soul adding warmth to every living space.



URBANWOOD





PRO

NATURE

URBANWOOD

ColorCode yaklaşımıyla İskandinav ahşapı modern dokuya sakince taşıyan porselen koleksiyonu. Urbanwood koleksiyonunda doğal ahşap, beton ile uyum sağlayarak şekil buluyor. Yüksek kaydırmazlığa sahip yüzeyi sayesinde Urbanwood, ticari ve kamusal alanlarda da güvenli kullanım sağlıyor.

A porcelain collection that uses the ColorCode approach to add a modern hue to the intrinsic serenity of Scandinavian wood. Natural wood and concrete combine effortlessly and harmoniously in the Urbanwood collection. The collection's highly effective anti-slip surface ensures that it is safe for all commercial and public uses.

Porselen Karolar / Porcelain Tiles

Bünye / Body Type

Sırlı Porselen/Glazed Porcelain

Fon Ebatları / Basic Tile Sizes

20x120 cm (R 197x1197 mm)

20x120 (206x1205 mm)

Yüzey Alternatifleri / Surface Alternatives

R10A

Fon Renkleri / Basic Tile Colors

Vizon / Mink

Koyu Grej / Dark Greige

Gri / Grey

Koyu Gri / Dark Grey

Kullanım Alanları / Usage Areas

Konut / Residential

Ticari Alan / Commercial

Döşeme Alanları / Tiling Areas

Yer / Floor

Duvar / Wall

Dona Dayanım / Frost Resistance

Var / Available

Desen Farklılaşması / Shade Variation Classification

V2

Baskı Teknolojisi / Printing Technology

ReaLook

Ürün Standardı / Product Standard

EN14411 Group Bla

Dip Notlar / Footnotes

F H R



Porselen
Porcelain



Yer Karosu
Floor Tile



Duvar Karosu
Wall Tile



Konut
Residential



Dona Dayanım
Frost Resistance



Mat
Matt



V2
Desen Farklılaşması
Shade Variation



Rektifiyeli
Rectified



Rektifiyesiz
Non Rectified



Yeni
Novelty

URBANWOOD

Porselen Karolar / Porcelain Tiles



20x120 R10A K947488R0001VTE0
20x120 R10A K94748800001VTE0

Vizon / Mink



20x120 R10A K947486R0001VTE0
20x120 R10A K94748600001VTE0

Koyu Grej / Dark Greige



20x120 R10A K947485R0001VTE0
20x120 R10A K94748500001VTE0

Gri - Grey



20x120 R10A K947487R0001VTE0
20x120 R10A K94748700001VTE0

Koyu Gri - Dark Grey



3,7x20 R10A K9475118R001VTE0

Chevron Dekor / Chevron Decor
Vizon / Mink



Yeni
Novelty



3,7x20 R10A K9475098R001VTE0

Chevron Dekor / Chevron Decor
Koyu Grej / Dark Greige



3,7x20 R10A K9475088R001VTE0

Chevron Dekor / Chevron Decor
Gri / Grey



3,7x20 R10A K9475108R001VTE0

Chevron Dekor / Chevron Decor
Koyu Gri / Dark Grey





ASPENWOOD

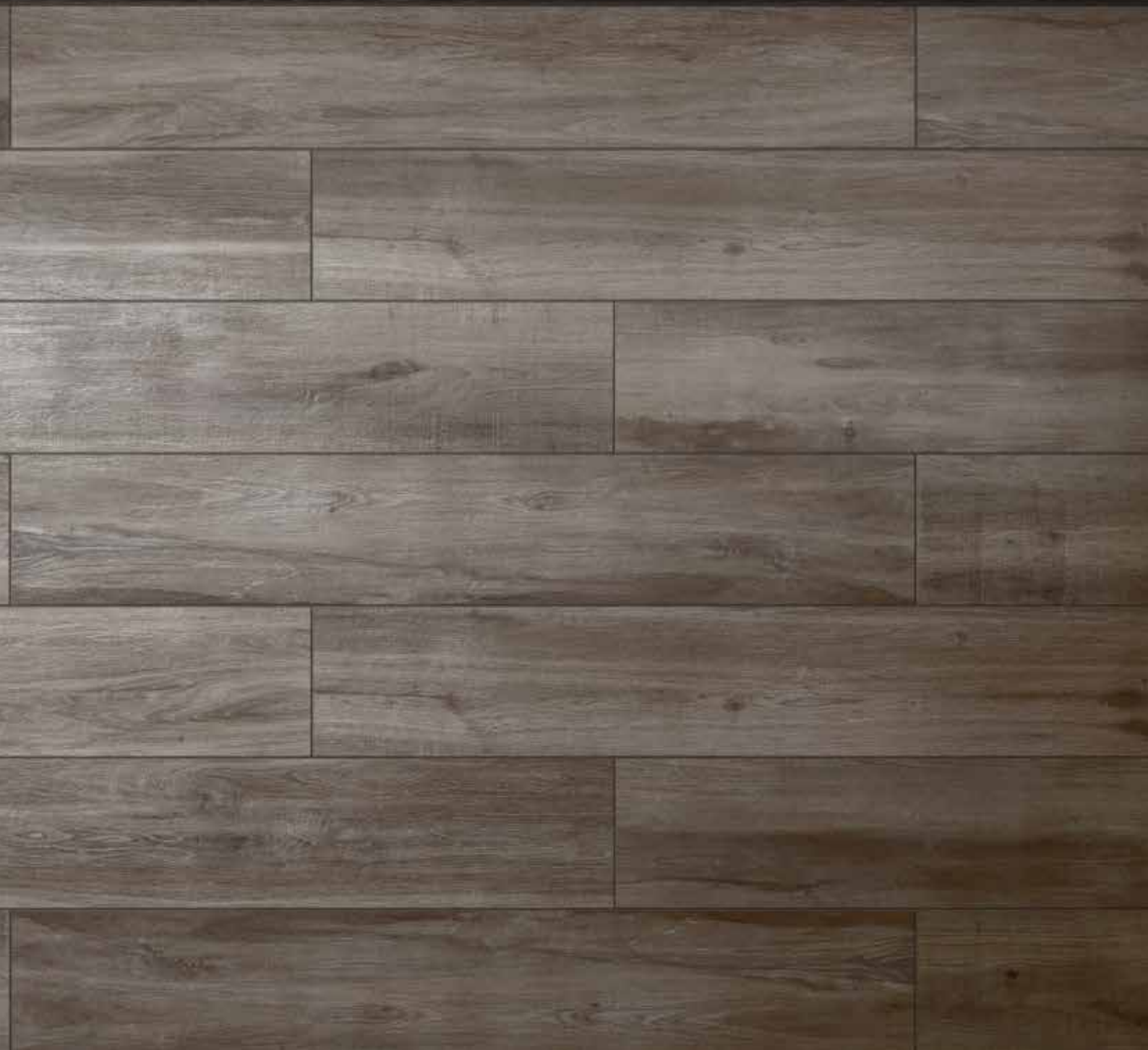





ASPENWOOD



PRO

NATURE

ASPENWOOD

Yüzeyle uygulandığında zengin tasarım ve kullanım imkanı sunan ahşap malzemenin farkı, biçimlendirme kabiliyetinde yatıyor. Ahşap dokulu seramik serisi Aspenwood, hamlıkla gelen yalınlığının yanı sıra coşkulu ve renkli seçenekler sunuyor. Aspen'in karakteristik doğası ve dağları çevreleyen ağaçlardan gelen saf ve ham yansımalar, bu seri ile mekanlara taşınıyor. Ürün yelpazesi, geleneksel ahşap görünümlü zeminler için doğal ahşap renk tonlarını, modern tasarım alanları içinse ham malzeme renk tonlarını içeriyor; R10 sınıfındaki kaymayı önleyici ürünler sayesinde restoran, otel ve ofis gibi alanlar için güvenli çözümler sunuyor.

The amazing quality of wood, which is bestowed with diverse possibilities of interpretations when applied in surface design, lies in its ability of modeling. Aspenwood is a wooden textured ceramic range; quiet and minimalist for the first and exuberant and colorful for the second. You can see the natural beauty of the trees and raw material look that revolves around the characteristics of Aspen mountains. The product range includes natural wood tones for traditional wood-looking floors, as well as greige tones for modern designed spaces. Thanks to its R10 class anti-slip products, the collection offers safe solutions for public spaces such as restaurants, hotels and offices.

Porselen Karolar / Porcelain Tiles

Bünye / Body Type

Sırlı Porselen / Glazed Porcelain

Yüzey Alternatifleri / Surface Alternatives

R10A

Fon Ebatları / Basic Tile Sizes

20x120 cm (R 197x1197 mm)

20X120 (205x1205 mm)

Fon Renkleri / Basic Tile Colors

Bej / Beige

Vizon / Mink

Grej / Greige

Koyu Grej / Dark Greige

Kızıl / Cherry

Venge / Wenge

Koyu Venge / Dark Wenge

Gri / Grey

Koyu Gri / Dark Grey

Antrasit / Anthracite

Kullanım Alanları / Usage Areas

Konut / Residential

Döşeme Alanları / Tiling Areas

Yer / Floor

Duvar / Wall

Dona Dayanım / Frost Resistance

Var / Available

Desen Farklılaşması / Shade Variation Classification

V3

Baskı Teknolojisi / Printing Technology

ReaLook

Ürün Standardı / Product Standard

EN14411 Group Bla

Dip Notlar / Footnotes

F G H R S



Porselen
Porcelain



Yer Karosu
Floor Tile



Duvar Karosu
Wall Tile



Konut
Residential



Dona Dayanım
Frost Resistance



Desen Farklılaşması
Shade Variation



Mat
Matt



Rektifiyeli
Rectified



Rektifiyesiz
Non-Rectified



Yeni
Novelty



Ödüllü
Award Winning



ASPENWOOD

Porselen Karolar / Porcelain Tiles



20x120 R10A K94569600001VTE0
20x120 R10A K945696R0001VTE0

Vizon / Mink



20x120 R10A K94569200001VTE0
20x120 R10A K945692R0001VTE0

Grej / Greige



20x120 R10A K94624100001VTE0
20x120 R10A K946241R0001VTE0

Koyu Grej / Dark Greige



20x120 R10A K94569300001VTE0
20x120 R10A K945693R0001VTE0

Gri / Grey



20x120 R10A K94569100001VTE0
20x120 R10A K945691R0001VTE0

Koyu Gri / Dark Grey



20x120 R10A K94569400001VTE0
20x120 R10A K945694R0001VTE0

Antrasit / Anthracite



20x120 R10A K94624200001VTE0
20x120 R10A K946242R0001VTE0

Bej / Beige



20x120 R10A K94624300001VTE0
20x120 R10A K946243R0001VTE0

Kizil / Cherry



20x120 R10A K94569500001VTE0
20x120 R10A K945695R0001VTE0

Venge / Wenge



20x120 R10A K94624400001VTE0
20x120 R10A K946244R0001VTE0

Koyu Venge / Dark Wenge

WOODMIX





PRO

NATURE

WOODMIX

Üstün porselen teknolojilerini doğal mat ahşap görüntüsü ile buluşturan seramik serisi. Oksitlenmiş doğal ve değişken ahşap tonları mimarlar ve iç mimarlar için mükemmel bir seçenek sunuyor. Tamamen doğal bir görüntü yaratmak için ürünlerde budak farklılıkları yer alıyor. Seri son yılların popüler İskandinav nordik ahşabının başarılı bir yorumu olarak dikkat çekiyor.

A ceramic series combining state of the art porcelain technology with natural matt wooden look. A perfect choice for architects and interior designers with its oxidized natural and variable wood shades. The series comes with wood pattern variations in order to give a full natural look. It is an ideal substitute to trending up Scandinavian nordic wood.

Porselen Karolar / Porcelain Tiles

Bünye / Body Type

Colorbody Porselen / Colorbody Porcelain

Yüzey Alternatifleri / Surface Alternatives

R10

Fon Ebatları / Basic Tile Sizes

60x120 cm (R 597x1197 mm)

30x120 cm (R 297x1197 mm)

20x120 cm (R 197x1197 mm)

Dekor Ebatları / Decor Sizes

30x60 cm (R 297x597 mm)

Fon ve Dekor Renkleri /

Basic Tile and Decor Colors

Krem / Cream

Bej / Beige

Moka / Mocha

Gri / Grey

Antrasit / Anthracite

Kullanım Alanları / Usage Areas

Konut / Residential

Ticari Alan / Commercial

Döşeme Alanları / Tiling Areas

Yer / Floor

Duvar / Wall

Dona Dayanım / Frost Resistance

Var / Available

Desen Farklılaşması / Shade Variation Classification

V4

Baskı Teknolojisi / Printing Technology

ReaLook

Ürün Standardı / Product Standard

EN14411 Group B1a

Dip Notlar / Footnotes

H I R



Porselen
Porcelain



Yer Karosu
Floor Tile



Duvar Karosu
Wall Tile



Dış Cephe
Facade



Konut
Residential



Ticari Alan
Commercial



Dona Dayanım
Frost Resistance



Desen Farklılaşması
Shade Variation



Mat
Matt



Rektifiyeli
Rectified



Ödüllü
Award Winning



WOODMIX

Porselen Karolar / Porcelain Tiles



60x120	R10	K946481R0001VTE0
30X120	R10	K944425R0001VTE0
20x120	R10	K944423R0001VTE0

Krem / Creme



30x60 R10 K0862238R001VTE0

Kesme Dekor / Cut Decor
Krem / Creme



60x120	R10	K946477R0001VTE0
30X120	R10	K943049R0001VTE0
20x120	R10	K943048R0001VTE0

Bej / Beige



30x60 R10 K0861618R001VTE0

Kesme Dekor / Cut Decor
Bej / Beige



60x120	R10	K946478R0001VTE0
30X120	R10	K943053R0001VTE0
20x120	R10	K943051R0001VTE0

Moka / Mocha



30x60 R10 K0861628R001VTE0

Kesme Dekor / Cut Decor
Moka / Mocha



60x120	R10	K946479R0001VTE0
30X120	R10	K943056R0001VTE0
20x120	R10	K943055R0001VTE0

Gri / Grey



30x60 R10 K9430578R001VTE0

Kesme Dekor / Cut Decor
Gri / Grey



60x120	R10	K946480R0001VTE0
30X120	R10	K944424R0001VTE0
20x120	R10	K944422R0001VTE0

Antrasit / Anthracite



30x60 R10 K0862228R001VTE0

Kesme Dekor / Cut Decor
Antrasit / Anthracite



PERA





PRO

NATURE

PERA

Adını aldığı şehir olan İstanbul gibi başka hiçbir yerde mümkün olmayacak bir ortam yaratan seramik serisi. Pera, gücün ve hassaslığın karışımını mekânlara yansıtıyor. Ahşap damarlarının düzeni ve kalıcı cazibesi, siyah ve beyazın muhteşem kontrastı ve geçmişin tasarımlarını hatırlatan rölyef deseniyle modern yaşama zamansızlık katıyor.

A ceramic series creating a totally original atmosphere just as İstanbul, the enchanting city giving its name to the series. Pera reflects the blend of power and sensitivity to spaces. Order and permanent attraction of wooden veins, excellent contrast between black and white, and relief patterns reminding the designs from the past serve to add a sense of timelessness to the modern life.

Porselen Karolar / Porcelain Tiles

Bünye / Body Type

Sırlı Porselen / Glazed Porcelain

Yüzey Alternatifleri / Surface Alternatives

R9

Fon Ebatları / Basic Tile Sizes

20x120 cm (R 197x1197 mm)

20x120 cm (204x1210 mm)

Dekor Ebatları / Decor Sizes

20x120 cm (R 197x1197 mm)

Fon ve Dekor Renkleri /

Basic Tile and Decor Colors

Beyaz / White

Gri / Grey

Siyah / Black

Kullanım Alanları / Usage Areas

Konut / Residential

Döşeme Alanları / Tiling Areas

Yer / Floor

Duvar / Wall

Dona Dayanım / Frost Resistance

Var / Available

Desen Farklılaşması /

Shade Variation Classification

V3

Baskı Teknolojisi / Printing Technology

ReaLook

Ürün Standardı / Product Standard

EN14411 Group B1a

Dip Notlar / Footnotes

H R



Porselen
Porcelain



Yer Karosu
Floor Tile



Duvar Karosu
Wall Tile



Dış Cephe
Facade



Konut
Residential



Dona Dayanım
Frost Resistance



Desen Farklılaşması
Shade Variation



Mat
Matt



Rektifiyeli
Rectified



Rektifiyesiz
Non Rectified



Ödüllü
Award Winning



PERA

Porselen Karolar / Porcelain Tiles



20x120 R9

K924211R0001VTEO

Beyaz / White



20x120 R9

K924255R0001VTEO

Dekor 1 / Decor 1
Beyaz / White



20x120 R9

K944493R0001VTEO

Eskitme Dekor / Decor
Beyaz / White



20x120 R9

K944491R0001VTEO

Gri / Grey



20x120 R9

K944492R0001VTEO

Dekor 1 / Decor 1
Gri / Grey



20x120 R9

K944494R0001VTEO

Eskitme Dekor / Decor
Gri / Grey



20x120 R9 K924222R0001VTEO

Siyah / Black



20x120 R9 K924270R0001VTEO

Dekor 1 / Decor 1
Siyah / Black



20x120 R9 K944495R0001VTEO

Eskitme Dekor / Decor
Siyah / Black



SAMBA





PRO

NATURE

SAMBA

Doğanın sürdürülebilir etkilerini mekânlara taşıyan seramik serisi. Samba, şehir hayatına uygun bir doku alternatifi sunuyor. Çok yönlülük ve sonsuz sayıda renk şeması ile uyumlu bir şekilde harmanlanabilme fırsatı sunan seri yepyeni ve etkili bir tarz yaratıyor.

A ceramic series bringing the sustainable effects of the nature to spaces. Samba offers an ideal alternative for urban areas. Giving the opportunity to match versatile designs with infinite number of colors, the series creates a totally new and effective style.

Porselen Karolar / Porcelain Tiles

Bünye / Body Type

Sırlı Porselen / Glazed Porcelain

Yüzey Alternatifleri / Surface Alternatives

R10

Fon Ebatları / Basic Tile Sizes

20x120 cm (R 197x1197 mm)

20x120 cm (204x1210 mm)

Dekor Ebatları / Decor Sizes

20x120 cm (R 197x1197 mm)

20x120 cm (204x1210 mm)

Fon ve Dekor Renkleri / Basic Tile and Decor Colors

Açık Meşe / Light Oak

Meşe / Oak

Bej / Beige

Venge / Wenge

Kullanım Alanları / Usage Areas

Konut / Residential

Döşeme Alanları / Tiling Areas

Yer / Floor

Duvar / Wall

Dona Dayanım / Frost Resistance

Var / Available

Desen Farklılaşması / Shade Variation Classification

V3

Baskı Teknolojisi / Printing Technology

ReaLook

Ürün Standardı / Product Standard

EN14411 Group B1a

Dip Notlar / Footnotes

H R



Porselen
Porcelain



Yer Karosu
Floor Tile



Duvar Karosu
Wall Tile



Dış Cephe
Facade



Konut
Residential



Dona Dayanım
Frost Resistance



Desen Farklılaşması
Shade Variation



Mat
Matt



Rektifiyesiz
Non Rectified



Rektifiyeli
Rectified



Ödüllü
Award Winning



SAMBA

Porselen Karolar / Porcelain Tiles



20X120 R10 K92537500001VTE0
20X120 R10 K925375R0001VTE0

Açık Meşe / Light Oak



20x120 R10 K94305800001VTE0
20x120 R10 K943058R0001VTE0

Meşe / Oak



20x120 R10 K94305900001VTE0
20x120 R10 K943059R0001VTE0

Açık Venge / Light Wenge



20x120 R10 K925353R0001VTE0
20x120 R10 K92535300001VTE0

Bej / Beige



20x120 R10 K92536400001VTE0
20x120 R10 K925364R0001VTE0

Venge / Wenge



20x120 R10 K08102100001VTE0
20x120 R10 K081021R0001VTE0

Dekor / Decor
Açık Meşe / Light Oak



20x120 R10 K08100600001VTE0
20x120 R10 K081006R0001VTE0

Dekor / Decor
Bej / Beige



20x120 R10 K08101000001VTE0
20x120 R10 K081010R0001VTE0

Dekor / Decor
Venge / Wenge



Yer Karoları / Floor Tiles : K909242R0001VTE0 Woodplus 15x90 Meşe / Oak

Duvar Karoları / Wall Tiles : K909253R0001VTE0 Woodplus 15x90 Açık Meşe / Light Oak

WOODPLUS





PRO

NATURE

WOODPLUS

Yaşam alanlarına ağacın sıcaklığını ve doğallığını taşıyan ahşap görümlü seramik serisi. Woodplus, doğa dostu yaklaşımıyla mekânlara şıklık katarken, 7 Farklı renk alternatifiyle mekânları zamanın ötesinde bir görünüme kavuşturuyor.

A ceramic series with wooden outlook reflecting the warmth and spontaneity of trees in living spaces. Woodplus adds a timeless elegance to spaces in an environmentally friendly manner with 7 different color alternatives.

Porselen Karolar / Porcelain Tiles

Bünye / Body Type

Sırlı Porselen / Glazed Porcelain

Yüzey Alternatifleri / Surface Alternatives

R10

Fon Ebatları / Basic Tile Sizes

15x90 cm (R 147x897 mm)

15x90 (147x897 mm)

Fon ve Dekor Renkleri / Basic Tile and Decor Colors

Antrasit / Anthracite

Koyu Gri / Dark Grey

Beyaz / White

Açık Meşe / Light Oak

Meşe / Oak

Venge / Wenge

Ceviz / Walnut

Kullanım Alanları / Usage Areas

Konut / Residential

Döşeme Alanları / Tiling Areas

Yer / Floor

Duvar / Wall

Dona Dayanım / Frost Resistance

Var / Available

Desen Farklılaşması / Shade Variation Classification

V2

Baskı Teknolojisi / Printing Technology

ReaLook

Ürün Standardı / Product Standard

EN14411 Group B1a

Dip Notlar / Footnotes

H R



Porselen
Porcelain



Yer Karosu
Floor Tile



Duvar Karosu
Wall Tile



Dış Cephe
Facade



Konut
Residential



Dona Dayanım
Frost Resistance



Desen Farklılaşması
Shade Variation



Mat
Matt



Rektifiyeli
Rectified



Rektifiyesiz
Non Rectified

WOODPLUS

Porselen Karolar / Porcelain Tiles



15x90 R10 K909253R0001VTEO
15x90 R10 K90925300001VTEO

Açık Meşe / Light Oak



15x90 R10 K909242R0001VTEO
15x90 R10 K90924200001VTEO

Meşe / Oak



15x90 R10 K909264R0001VTEO
15x90 R10 K90926400001VTEO

Ceviz / Walnut



15x90 R10 K909231R0001VTEO
15x90 R10 K90923100001VTEO

Venge / Wenge



Beyaz / White

15x90 R10 K932983R0001VTEO
15x90 R10 K93298300001VTEO



Koyu Gri / Dark Grey

15x90 R10 K932994R0001VTEO
15x90 R10 K93299400001VTEO



Antrasit / Anthracite

15x90 R10 K933005R0001VTEO
15x90 R10 K93300500001VTEO



Yer Karosu/ Floor Tiles : K924211R0001VTE0 20x120 Pera Beyaz / White

Duvar Karoları / Wall Tiles : K929726R0001VTS0 33x100 Provence Geometrik Dekor / Geometric Decor Beyaz / White
K082605R0001VTS0 11x33 Provence Altın Bordür 1 Gold Border 1 Beyaz / White
K08293300001VTS0 3x33 Provence Bordür / Border Altın / Gold
K929903R0001VTS0 15x33 Provence Süpürgelik / Plinth Grej / Greige

PROVENCE



Duvar Karoları / Wall Tiles

Fon Ebatları / Basic Tile Sizes
33x100 cm (R 329x991 mm)

Dekor Ebatları / Decor Sizes
33x100 cm (R 329x991 mm)
11x33 cm (Bordür / Border)
5x33 cm (Bordür / Border)
3x33 cm (Bordür / Border)
2x33 cm (Bordür / Border)
15x33 cm (Süpürgelik / Plinth)

**Fon ve Dekor Renkleri /
Basic Tile and Decor Colors**
Beyaz / White
Grej / Greige

Kullanım Alanları / Usage Areas
Konut / Residential

Döşeme Alanları / Tiling Areas
Duvar / Wall

Dona Dayanım / Frost Resistance
Yok / Not Available

**Desen Farklılaşması /
Shade Variation Classification**
V3

Baskı Teknolojisi / Printing Technology
ReaLook

Ürün Standardı / Product Standard
EN14411 Group BIII

Dip Notlar / Footnotes

H B

PRO

NATURE

PROVENCE

Versay Sarayı'nda bulunan ve "boiserie" olarak adlandırılan ahşap duvar panellerinden ilham alan seramik serisi. Provence, dekorlardaki altın kaplamalı alternatifleri ile modern mekânlara klasik bir atmosfer kazandırıyor. Pudra tonlarının mat ve eskitilmiş doğal görünümü ve bu doğallıkla kontrast yaratan değerli taş ışlıklarının uyumu sıra dışı bir atmosfer yaratıyor.

A ceramic series inspired by framed wooden panels, which are known as "boiserie" with the most distinguished examples found in Versailles Palace. Provence gives a classic atmosphere to modern spaces with gold plated decors. The series creates an unusual atmosphere thanks to the matt and worn outlook of powder hues and contrasting gleams of precious stones.



PROVENCE

Duvar Karoları / Wall Tiles



Beyaz / White

33x100 K929601R0001VTS0



Grej / Greige

33x100 K929623R0001VTS0



Çiçekli Dekor / Floral Decor
Grej / Greige

33x100 Beyaz / White K929645R0001VTS0
33x100 Grej / Greige K929660R0001VTS0



Geometrik Dekor / Geometric Decor
Grej / Greige

33x100 Beyaz / White K929726R0001VTS0
33x100 Grej / Greige K929741R0001VTS0



33x100 Beyaz / White
33x100 Grej / Greige

K929682R0001VTSO
K929704R0001VTSO

Çizgili Dekor / Lines Decor
Grej / Greige



33x100 Beyaz / White
33x100 Grej / Greige

K082524R0001VTSO
K082546R0001VTSO

Çiçekli Altın Dekor / Floral Gold Decor
Grej / Greige



33x100 Beyaz / White
33x100 Grej / Greige

K082561R0001VTSO
K082583R0001VTSO

Geometrik Altın Dekor / Geometric Gold Decor
Grej / Greige



11x33 Beyaz / White
Grej / Greige

K082605R0001VTEO
K082620R0001VTEO

Altın Bordür 1
Gold Border 1
Grej / Greige



11x33 Beyaz / White
Grej / Greige

K929763R0001VTEO
K929785R0001VTEO

Bordür 1 / Border 1
Grej / Greige



3x33 Altın / Gold

K08293300001VTEO

Kaplama Bordür
Covering Border
Altın / Gold



11x33 Beyaz / White
Grej / Greige

K082642R0001VTEO
K082664R0001VTEO

Çiçekli Altın Bordür 2
Floral Gold Border 2
Grej / Greige



2x33 Altın / Gold

K08296600001VTEO

Pencil Bordür
Pencil Border
Altın / Gold



11x33 Beyaz / White
Grej / Greige

K929800R0001VTEO
K929822R0001VTEO

Floral Border 2
Grej / Greige



5x33 Altın / Gold

K08295500001VTEO

Geometrik Bordür
Geometric Border
Altın / Gold



15x33 Beyaz / White
Grej / Greige

K929881R0001VTEO
K929903R0001VTEO

Süpürgelik / Plinth
Grej / Greige



MARBLE DREAM

MERMER RÜYASI

Mermer, doğanın yaratıcılığa, sanata ve mimariye sunduğu en değerli hazinesi. Yarattığı atmosfer ve tasarım zenginliği, sizin için modern yaşamın coşkusu ile klasiğin seçkin zevkini bir araya getiriyor.

Marble is the nature's most precious treasure for creativity, art and architecture. The atmosphere it creates and the diversity in designing combines the passion of modern life and the elite pleasure of the classic for you.



MARMORI

RECEPTION





RECEPTION

PRO

NATURE

MARMORI

Klasik mermerlerin en seçkin sekiz örneğini birlikte sunan mermer görünümlü porselen karo serisi. Koleksiyon, siyah renkli Saint Laurent Nero, beyaz renkli Calacatta, Carrara mermerleri ve krem ile bronzun bir araya geldiği Pulpis mermerlerinden ilham alan doğal görünümlü seramiklerin yanı sıra grej, fildişi, gri renk yelpazesindeki mermerler ile öne çıkıyor. Siyah ve beyazın zıtlıklardan beslenen çarpıcı uyumu, klasiğin modası geçmeyecek sadeliğini kullanıldığı mekânlara taşıyor. Krem ve bronzun zarafeti ise iç mekânlara zenginlik ve asalet kazandırıyor. Birbiriyle kontrast içinde kullanılacak renkleri sayesinde koleksiyon, sınırsız bir tasarım özgürlüğü sunuyor.

Marble textured porcelain tile series which combines the most elegant examples of classical marbles. The collection stands out with the natural looking tiles inspired by black Saint Laurent Nero, white Calacatta, Carrara and cream / bronze Pulpis marbles as well as the marbles in the range of greige, ivory and grey colors. Its eye-catching harmony nourished by the contrasts of white and black, carries the timeless simplicity of classic to the spaces it is used. On the other hand, the delicacy of cream and bronze adds richness and nobility to interior spaces. The collection offers an unlimited freedom of design, thanks to natural marble colors that can be used in contrast with each other.

Porselen Karolar / Porcelain Tiles

Bünye / Body Type

Sırlı Porselen / Glazed Porcelain

Yüzey Alternatifleri / Surface Alternatives

FLPR

LPR

Fon Ebatları / Basic Tile Sizes

60x120 cm (R 597x1197 mm)

60x60 cm (R 597x597 mm)

30x60 cm (R 297x297 mm)

Fon Renkleri / Basic Colors

Gold Calacatta Beyaz / White

Carrara Beyaz / White

Pulpis Fildişi / Ivory

Royal Fildişi / Ivory

Fior Grej / Greige

Cloud Gri / Grey

Pulpis Bronz / Bronze

St. Laurent Siyah / Black

Kullanım Alanları / Usage Areas

Konut / Residential

Döşeme Alanları / Tiling Areas

Duvar / Wall

Yer / Floor

Dona Dayanım / Frost Resistance

Var / Available

Desen Farklılaşması / Shade Variation Classification

V3

Baskı Teknolojisi / Printing Technology

ReaLook

Ürün Standardı / Product Standard

EN14411 Group Bla

Dip Notlar / Footnotes

G H P R



Porselen
Porcelain



Yer Karosu
Floor Tile



Duvar Karosu
Wall Tile



Diş Cephe
Facade



Konut
Residential



Dona Dayanım
Frost Resistance



V3
Desen Farklılaşması
Shade Variation



Full
Lappato



Rektifiyeli
Rectified



Lappato

MARMORI

Porselen Karolar / Porcelain Tiles



Gold Calacatta Beyaz / White

60x120	FLPR	K947021FLPR1VTE0
60x60	FLPR	K947000FLPR1VTE0
30x60	FLPR	K947020FLPR1VTE0

60x120	LPR	K947021LPR01VTE0
60x60	LPR	K945331LPR01VTE0



Carrara Beyaz / White

60x120	FLPR	K947023FLPR1VTE0
60x60	FLPR	K947015FLPR1VTE0
30x60	FLPR	K947009FLPR1VTE0

60x120	LPR	K947870LPR01VTE0
60x60	LPR	K946537LPR01VTE0



60x120	FLPR	K947005FLPR1VTEO
60x60	FLPR	K947014FLPR1VTEO
30x60	FLPR	K947008FLPR1VTEO

Pulpis Fildişi / Ivory



60x120	FLPR	K947017FLPR1VTEO
60x60	FLPR	K947002FLPR1VTEO
30x60	FLPR	K947004FLPR1VTEO

Royal Krem / Cream

MARMORI

Porselen Karolar / Porcelain Tiles



60x120	FLPR	K947018FLPR1VTEO
60x60	FLPR	K947003FLPR1VTEO
30x60	FLPR	K947016FLPR1VTEO

Fior Grej / Greige



60x120	FLPR	K947019FLPR1VTEO
60x60	FLPR	K947007FLPR1VTEO
30x60	FLPR	K947010FLPR1VTEO

60x120	LPR	K947871LPR01VTEO
60x60	LPR	K946538LPR01VTEO

Cloud Gri / Grey



60x120	FLPR	K947013FLPR1VTE0
60x60	FLPR	K947001FLPR1VTE0
30x60	FLPR	K947022FLPR1VTE0

Pulpis Bronz / Bronze

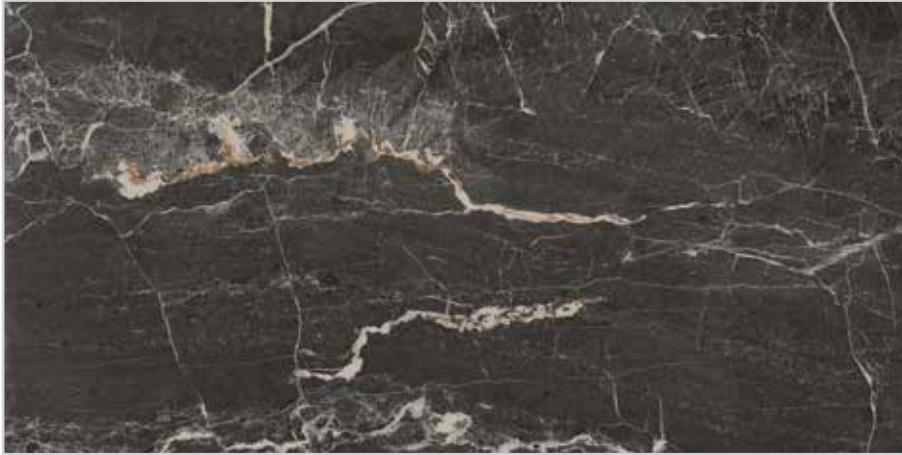

60x120	FLPR	K947011FLPR1VTE0
60x60	FLPR	K947006FLPR1VTE0
30x60	FLPR	K947012FLPR1VTE0
60x120	LPR	K947869LPR01VTE0
60x60	LPR	K945332LPR01VTE0

St. Laurent Siyah / Black



Yer Karoları / Floor Tiles : K942998HR001VTE0 80x80 Calacatta Beyaz / White
K933020R0001VTE0 22,5x90 Woodplus Koyu Gri / D. Grey

Duvar Karoları / Wall Tiles : K942998HR001VTE0 80x80 Calacatta Beyaz / White
K943345HR001VTE0 40x80 Calacatta Beyaz / White
K943010R0001VTE0 80x80 Calacatta Rigato Dekor / Rigato Decor Beyaz / White

CALACATTA





PRO

NATURE

CALACATTA

Dünyaca ünlü lüks calacatta mermerinden esinlenen seramik serisi. Bembeyaz zemin üzerinde yer alan gri damarlı yapısıyla banyo, mutfak ve diğer yaşam alanlarında modern bir atmosfer yaratıyor. Seri, honed touch parlak saten yüzeyi ve rigato dekoruyla yer ve duvar kullanımına uygun.

A ceramic series inspired by the world famous Italian luxury marble; calacatta. It has grey shades on clear white background and can be used to create a fresh look in modern bathrooms, kitchens and other living spaces. The colorbody porcelain series is suitable for both wall and floor use, with honed touch surface alternatives and complemented with rigato decors.

Porselen Karolar / Porcelain Tiles

Bünye / Body Type

Colorbody Porselen / Colorbody Porcelain (R9)

Yüzey Alternatifleri / Surface Alternatives

R9

Honed Touch (HT)

FLPR

R10B

Fon Ebatları / Basic Tile Sizes

80x80 cm (R 797x797 mm)

40x80 cm (R 397x797mm)

60x120 cm (R 597x1197 mm)

20x120 cm (R 197x1197 mm)

60x60 cm (R 597x597 mm)

Dekor Ebatları / Decor Sizes

80x80 cm (R 797x797 mm)

Fon ve Dekor Renkleri / Basic Tile and Decor Colors

Beyaz / White

Kullanım Alanları / Usage Areas

Konut / Residential

Ticari Alan / Commercial

Döşeme Alanları / Tiling Areas

Duvar / Wall

Yer / Floor

Dona Dayanım / Frost Resistance

Var / Available

Desen Farklılaşması / Shade Variation Classification

V3

Baskı Teknolojisi / Printing Technology

ReaLook

Ürün Standardı / Product Standard

EN14411 Group B1a

Dip Notlar / Footnotes

H R



Porselen
Porcelain



Yer Karosu
Floor Tile



Duvar Karosu
Wall Tile



Dış Cephe
Facade



Konut
Residential



Ticari Alan
Commercial



Dona Dayanım
Frost Resistance



Desen Farklılaşması
Shade Variation



Mat
Matt



Full
Lappato



Honed
Touch



Rektifiyeli
Rectified



Rektifiyesiz
Non Rectified

CALACATTA

Porselen Karolar / Porcelain Tiles



60X120	FLPR	K943006FLPR1VTE0
20X120	FLPR	K943007FLPR1VTE0
60x60	FLPR	K943958FLPR1VTE0
80x80	R9	K942998R0001VTE0
40x80	R9	K942999R0001VTE0
80x80	HT	K942998HR001VTE0
60x60	HT	K943959HR001VTE0
40x80	HT	K943345HR001VTE0
60X60	R10B	K947749R0001VTE0

Beyaz / White



80x80 R9 K943010R0001VTE0

Rigato Dekor / Rigato Dekor
Beyaz / White





Yer Karoları / Floor Tiles : K946272LPR01VTE0 60x60 Statua Beyaz / White

Duvar Karoları / Wall Tiles : K946269R0001VTS0 33x100 Beyaz / White
K946270R0001VTS0 33x100 Statua Beyaz Çizgi Dekor / White Line Decor
K946271R0001VTS0 33x100 Statua Beyaz Dalga Dekor / White Wave Decor

STATUA



PRO

NATURE

STATUA

İç mekân tasarımlarının değerini hiç kaybetmeyen klasiği; altın damarlı şık Calacatta mermerini yeniden yorumlayan seramik serisi. Doğal mermer işleme tekniklerinden ilham alan üç boyutlu dekorları ve zengin damarlı dokusu, seriye klasik bir mermer sütunun zamansız güzelliğini kazandırıyor. Kullanıldığı duvarlarda güçlü bir tasarım ifadesi sunan seri, klasiğin eskimeyen çizgilerini modern tasarımın yalın dengesiyle birleştiriyor.

Ceramic collection which interprets a classic of interior design; golden-grain elegant Calacatta marble. Inspired by natural marble engraving methods, its 3D decors and rich grained texture introduce the timeless beauty of classical marble pillar to the collection. Reflecting a strong design expression on the walls it is used, the collection combines the ageless lines of classic with simple balance of contemporary design.

Duvar Karoları / Wall Tiles

Yüzey Alternatifleri / Surface Alternatives
Parlak / Glossy

Fon Ebatları / Basic Tile Sizes
33x100 cm (R 329x991 mm)

Dekor Ebatları / Decor Sizes
33x100 cm (R 329x991 mm)

**Fon ve Dekor Renkleri /
Basic Tile and Decor Colors**
Beyaz / White

Kullanım Alanları / Usage Areas
Konut / Residential

Döşeme Alanları / Tiling Areas
Duvar / Wall

Dona Dayanım / Frost Resistance
Yok / Not Available

**Desen Farklılaşması /
Shade Variation Classification**
V4

Baskı Teknolojisi / Printing Technology
ReaLook

Ürün Standardı / Product Standard
EN14411 Group BIII

Dip Notlar / Footnotes
H R



Yeni
Novelty



Duvar Karosu
Wall Tile



Konut
Residential



Parlak
Glossy



Rektifiyeli
Rectified



Desen Farklılaşması
Shade Variation



Ödüllü
Award Winning



GOOD
DESIGN
AWARD
2018

Porselen Karolar / Porcelain Tiles

Bünye / Body Type

Sırlı Porselen / Glazed Porcelain

Yüzey Alternatifleri / Surface Alternatives

LPR

FLPR

Fon Ebatları / Basic Tile Sizes

60x60 cm (597x597 mm)

Fon Renkleri /

Basic Tile and Decor Colors

Beyaz / White

Kullanım Alanları / Usage Areas

Konut / Residential

Döşeme Alanları / Tiling Areas

Yer / Floor

Duvar / Wall

Dona Dayanım / Frost Resistance

Var / Available

Desen Farklılaşması /

Shade Variation Classification

V4

Baskı Teknolojisi / Printing Technology

ReaLook

Ürün Standardı / Product Standard

EN14411 Group B1a

Dip Notlar / Footnotes



Yeni
Novelty



Porselen
Porcelain



Yer Karosu
Floor Tile



Duvar Karosu
Wall Tile



Konut
Residential



Dona Dayanım
Frost Resistance



Desen Farklılaşması
Shade Variation



Lappato



Full Lappato



Rektifiyeli
Rectified

STATUA

Duvar Karoları / Wall Tiles



33x100 Parlak / Glossy K946269R0001VTS0

Beyaz / White



33x100 Parlak / Glossy K946270R0001VTS0

Çizgi Dekor / Line Decor
Beyaz / White



33x100 Parlak / Glossy K946271R0001VTS0

Dalga Dekor / Wave Decor
Beyaz / White



1x100 K946661LZ001VTE0

Çubuk Bordür - Logolu / Line Border - Logo
Pirinç / Brass



1x100 K94666100001VTE0

Çubuk Bordür / Line Border
Pirinç / Brass

Porselen Karolar / Porcelain Tiles



60x60 LPR K946272LPR01VTEO
60x60 FLPR K946272FLPR1VTEO

Beyaz / White



Duvar Karoları / Wall Tiles : K945000R0001VTS0 33x100 Metamarmo Mavi / Blue
K945078R0001VTS0 33x100 Metamarmo 3D Büyük Dalga Dekor/ 3D Large Wave Decor Mavi / Blue
K944999R0001VTS0 33x100 Metamarmo Küçük Dalga Dekor / Small Wave Decor Beyaz / White
K356997LZ001VTS0 1x100 Metamarmo Bakır Çubuk Bordür / Copper Line Border

METAMARMO



PRO

NATURE

METAMARMO

Akışkan mermer damarlarının çarpıcı renklerini ve gökyüzünün ışıltısını içinde barındıran mermer dokulu seramik serisi. Metalik tamamlayıcı parçaları, olağanüstü güzellikte renkleri, üç boyutlu rölyefleri ve bakır bordürleri ile kullanıldığı mekânlara cesur, yeni bir hava kazandırıyor.

Marble-textured ceramic series which blend attractive colours of fluid marble grains and glimmer of the sky. It brings a bold look to modern spaces, with its complementary metallic parts, extraordinarily beautiful colours, 3D reliefs and copper borders.

Duvar Karoları / Wall Tiles

Fon Ebatları / Basic Tile Sizes
33x100 cm (R 329x991 mm)

Dekor ve Bordür Ebatları / Decor and Border Sizes

33x100 cm (R 329x991 mm)
1x100 cm (Bordür / Border)
4x33 cm (Bordür / Border)

Yüzey Alternatifleri / Surface Alternatives

Parlak / Glossy

Fon ve Dekor Renkleri / Basic Tile and Decor Colors

Beyaz / White
Krem / Cream
Mavi / Blue

Kullanım Alanları / Usage Areas

Konut / Residential
Ticari Alan / Commercial

Döşeme Alanları / Tiling Areas

Duvar / Wall

Dona Dayanım / Frost Resistance

Yok / Not Available

Baskı Teknolojisi / Printing Technology

ReaLook

Ürün Standardı / Product Standard

EN14411 Group BIII

Dip Notlar / Footnotes

H B R



Duvar Karosu
Wall Tile



Ticari Alan
Commercial



Konut
Residential



Parlak
Glossy



Rektifiyeli
Rectified



Desen Farklılaşması
Shade Variation



Ödüllü
Award Winning



Porselen Karolar / Porcelain Tiles

Bünye / Body Type

Sırlı Porselen / Glazed Porcelain

Yüzey Alternatifleri / Surface Alternatives

LPR
FLPR

Fon Ebatları / Basic Tile Sizes

60x60 cm (597x597 mm)

Fon ve Dekor Renkleri / Basic Tile and Decor Colors

Krem / Cream

Kullanım Alanları / Usage Areas

Konut / Residential
Ticari Alan (Düşük Trafik) /
Commercial (Low Traffic)

Döşeme Alanları / Tiling Areas

Yer / Floor
Duvar / Wall

Dona Dayanım / Frost Resistance

Var / Available

Desen Farklılaşması / Shade Variation Classification

V4

Baskı Teknolojisi / Printing Technology

ReaLook

Ürün Standardı / Product Standard

EN14411 Group B1a

Dip Notlar / Footnotes

H



Porselen
Porcelain



Yer Karosu
Floor Tile



Duvar Karosu
Wall Tile



Konut
Residential



Rektifiyeli
Rectified



Dona Dayanım
Frost Resistance



Desen Farklılaşması
Shade Variation



Lappato



Ödüllü
Award Winning



Full
Lappato



METAMARMO

Duvar Karoları / Wall Tiles



Krem / Cream

33x100

Parlak / Glossy

K944996R0001VTSO



3D Büyük Dalga Dekor / 3D Large Wave Decor
Krem / Cream

33x100

Parlak / Glossy

K944709R0001VTSO

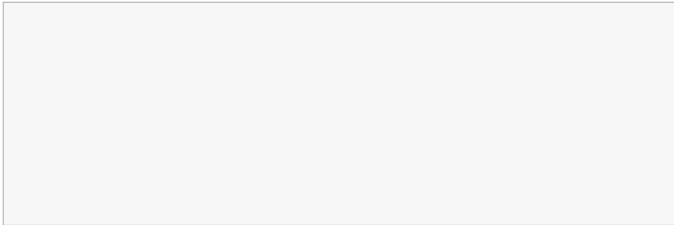

Düz Beyaz / Plain White

33x100

Parlak / Glossy

K944998R0001VTSO

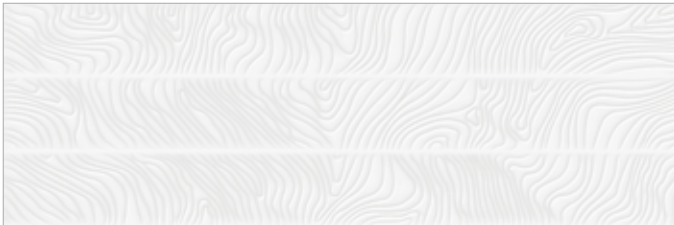

Küçük Dalga Dekor / Small Wave Decor
Beyaz / White

33x100

Parlak / Glossy

K944999R0001VTSO



Mavi / Blue

33x100 Parlak / Glossy K945000R0001VTSO

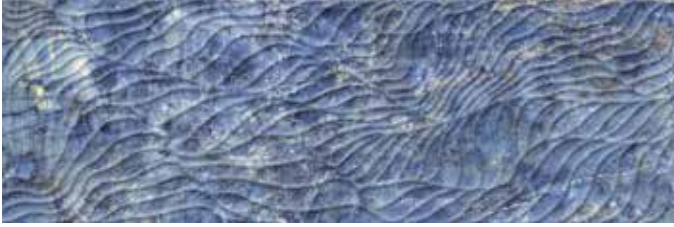

3D Büyük Dalga Dekor/ 3D Large Wave Decor
Mavi / Blue

33x100 Parlak / Glossy K945078R0001VTSO



Bakır Çubuk Bordür - Logolu / Copper Line Border - Logo

1x100 K356997LZ001VTEO



Bakır Çubuk Bordür / Copper Line Border

1x100 K35699700001VTEO



Bakır Bordür / Copper Border

4x33 Parlak / Glossy K35701600001VTEO

Porselen Karolar / Porcelain Tiles



Krem / Cream

60x60 LPR K945020LPR01VTEO
60x60 FLPR K945021FLPR1VTEO



Duvar Karoları / Wall Tiles : K937824R0001VTS0 33x100 Versus - XL Beyaz / White
K941221R0001VTS0 33x100 Versus - XL Dalgalı Dekor / Wave Decor Beyaz / White
K08601300001VTS0 3x100 Bordür Gümüş / Border Silver

VERSUS - XL



PRO

NATURE

VERSUS - XL

Silver fantasy mermerini, doğalına en yakın tonlarıyla mekânlara yansıtan yeni seramik serisi. Duvar seramiklerinin yanı sıra aynı tasarım dilinde porselenlere de sahip Versus, zıtlıklardan besleniyor; döşendiği her ortamda minimal ve modern bir algı yaratıyor. Soğuk mermer dokusunun bronz renkteki parlak paslanmaz metal çubuklarla yarattığı zıtlık, duvarlara yepyeni bir görünüm kazandırıyor.

A new ceramic series using silver fantasy marble with hues which are closest to its natural color. Presented with porcelain tiles in addition to its wall tiles, Versus is enriched with contrasts creating a sense of minimalism and modernity in all spaces. The contrast created by the cool marble tissue with glossy stainless steel bars of bronze color gives a brand new outlook to walls.

Duvar Karoları / Wall Tiles

Yüzey Alternatifleri / Surface Alternatives

Parlak / Glossy

Fon Ebatları / Basic Tile Sizes

33x100 cm (R 329x991 mm)

Dekor Ebatları / Basic Decor Sizes

33x100 cm (R 329x991 mm)

3x100 cm (Bordür / Border)

Fon ve Dekor Renkleri / Basic Tile and Decor Colors

Beyaz / White

Gri / Grey

Kullanım Alanları / Usage Areas

Konut / Residential

Döşeme Alanları / Tiling Areas

Duvar / Wall

Dona Dayanım / Frost Resistance

Yok / Not Available

Desen Farklılaşması / Shade Variation Classification

V3

Baskı Teknolojisi / Printing Technology

ReaLook

Ürün Standardı / Product Standard

EN14411 Group BIII

Dip Notlar / Footnotes

H R



Duvar Karosu
Wall Tile



Konut
Residential



Desen Farklılaşması
Shade Variation



Rektifiyeli
Rectified



Parlak
Glossy



Ödüllü
Award Winning



GOOD DESIGN
AWARD 2015

Porselen Karolar / Porcelain Tiles

Bünye / Body Type

Colorbody Porselen / Colorbody Porcelain
Sırlı Porselen / Glazed Porcelain

Yüzey Alternatifleri / Surface Alternatives

R9
Honed Touch (HT)
LPR
FLPR

Fon Ebatları / Basic Tile Sizes

80x80 cm (R 797x797 mm)
60x60 cm (R 597x597 mm)

Fon Renkleri / Basic Tile Colors

Beyaz / White
Anthracite / Antrasit

Kullanım Alanları / Usage Areas

Konut / Residential
Ticari Alan / Commercial

Döşeme Alanları / Tiling Areas

Duvar / Wall
Yer / Floor

Dona Dayanım / Frost Resistance

Var / Available

Desen Farklılaşması / Shade Variation Classification

V3

Baskı Teknolojisi / Printing Technology

ReaLook

Ürün Standardı / Product Standard

EN14411 Group B1a

Dip Notlar / Footnotes

H R



Porselen
Porcelain



Yer Karosu
Floor Tile



Duvar Karosu
Wall Tile



Konut
Residential



Ticari Alan
Commercial



Dona Dayanım
Frost Resistance



Desen Farklılaşması
Shade Variation



Full
Lappato



Lappato



Rektifiyeli
Rectified



GOOD DESIGN
AWARD 2015

VERSUS - XL

Duvar Karoları / Wall Tiles



33x100

Parlak / Glossy

K937824R0001VTS0

Beyaz / White



33x100

Parlak / Glossy

K941221R0001VTS0

Dalga Dekor / Wave Decor
Beyaz / White



33x100

Parlak / Glossy

K938966R0001VTS0

Süpürgelik / Plinth
Beyaz / White



33x100

Parlak / Glossy

K939320R0001VTS0

Gri / Grey



33x100

Parlak / Glossy

K941232R0001VTS0

Dalga Dekor / Wave Decor
Gri / Grey

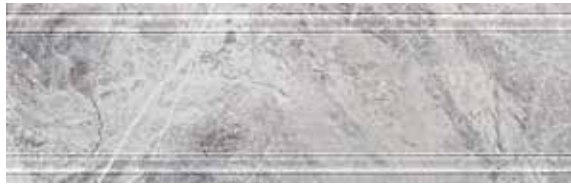

33x100

Parlak / Glossy

K939331R0001VTS0

Süpürgelik / Plinth
Gri / Grey



3x100

Parlak / Glossy

K085976LZ001VTE0

Bakır Çubuk Bordür - Logolu / Copper Line Border - Logo



3x100

Parlak / Glossy

K08597600001VTE0

Bakır Çubuk Bordür / Copper Line Border



3x100

Parlak / Glossy

K086013LZ001VTE0

Gümüş Çubuk Bordür - Logolu / Silver Line Border - Logo



3x100

Parlak / Glossy

K08601300001VTE0

Gümüş Çubuk Bordür / Silver Line Border

Porselen Karolar / Porcelain Tiles



Beyaz / White

80x80	R9	K938432R0001VTE0
80x80	HT	K938432HR001VTE0
60x60	LPR	K944103LPR01VTE0
60x60	FLPR	K938351FLPR1VTE0



Rigato Dekor / Rigato Decor
Beyaz / White

80x80	R9	K943034R0001VTE0
-------	----	------------------



Antrasit / Anthracite

80x80	R9	K939353R0001VTE0
80x80	HT	K939353HR001VTE0
60x60	LPR	K943302LPR01VTE0
60x60	FLPR	K939342FLPR1VTE0

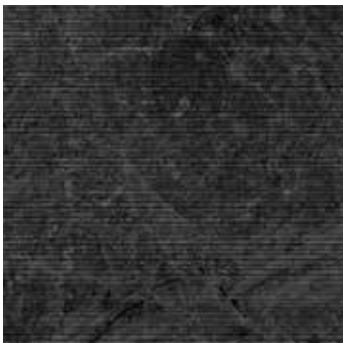

Rigato Dekor / Rigato Decor
Antrasit / Anthracite

80x80	R9	K943040R0001VTE0
-------	----	------------------



Yer Karoları / Floor Tiles : K928971FLPR1VTE0 60x60 Inside - XL Kum Rengi / Sand

Duvar Karoları / Wall Tiles : K928886R0001VTS0 33x100 Inside - XL Kum Rengi / Sand
K928912R0001VTS0 33x100 Inside - XL Panel Dekor / Panel Decor Kum Rengi / Sand
K082384R0001VTS0 33x100 Inside - XL Süpürgelik / Planth Kum Rengi / Sand

INSIDE - XL



PRO

NATURE

INSIDE - XL

Madrid şehrinden ilham alınarak dünyaca ünlü İspanyol mermeri Emprador'un dokusu ile tasarlanan seramik serisi. Inside, yoğun damarlı yapısı ve doğal renkleriyle mekânlarda ihtişamlı bir atmosfer yaratıyor. Seriyi tamamlayan panel dekoru, mermerin asaletini, eski çağlardan kalma görünümü dev floral deseniyle duvarlara taşıyor.

A ceramic series reflecting the texture of world famous Spanish marble Emprador with inspiration from Madrid, inside creates a magnificent atmosphere with its intense venous structure and natural colors. The panel decor complementing the series brings the noble character of marble to walls with gigantic floral pattern reminding one of the ancient times.

Duvar Karoları / Wall Tiles

Yüzey Alternatifleri / Surface Alternatives
Parlak / Glossy

Fon Ebatları / Basic Tile Sizes
33x100 cm (R 329x991 mm)

Dekor ve Bordür Ebatları / Decor and Border Sizes
33x100 cm (R 329x991 mm)
16,5x100 cm (Bordür / Border)

Fon ve Dekor Renkleri / Basic Tile and Decor Colors
Sand / Sand
Gri / Grey
Vizon / Mink

Kullanım Alanları / Usage Areas
Konut / Residential

Döşeme Alanları / Tiling Areas
Duvar / Wall

Dona Dayanım / Frost Resistance
Yok / Not Available

Baskı Teknolojisi / Printing Technology
ReaLook

Ürün Standardı / Product Standard
EN14411 Group BIII

Dip Notlar / Footnotes

H R



Duvar Karosu
Wall Tile



Konut
Residential



Rektifiyeli
Rectified



Parlak
Glossy



Desen Farklılaşması
Shade Variation

Porselen Karolar / Porcelain Tiles

Bünye / Body Type

Sırlı Porselen / Glazed Porcelain (FLPR)

Yüzey Alternatifleri / Surface Alternatives

FLPR

Fon ve Dekor Ebatları / Basic Tile and Decor Sizes

60x60 cm (R 597x597 mm)

Fon Renkleri / Basic Tile Colors

Sand / Sand
Gri / Grey
Vizon / Mink

Dekor Renkleri / Decor Colors

Gri-Sand / Grey-Sand
Vizon-Sand / Mink-Sand

Kullanım Alanları / Usage Areas

Konut / Residential
Ticari Alan (Düşük Trafik) /
Commercial (Low Traffic)

Döşeme Alanları / Tiling Areas

Duvar / Wall
Yer / Floor

Dona Dayanım / Frost Resistance

Var / Available

Desen Farklılaşması / Shade Variation Classification

V3

Baskı Teknolojisi / Printing Technology

ReaLook

Ürün Standardı / Product Standard

EN14411 Group B1a

Dip Notlar / Footnotes

H R



Porselen
Porcelain



Yer Karosu
Floor Tile



Duvar Karosu
Wall Tile



Konut
Residential



Dona Dayanım
Frost Resistance



Desen Farklılaşması
Shade Variation



Rektifiyeli
Rectified



Full
Lappato

INSIDE - XL

Duvar Karoları / Wall Tiles



Vizon / Mink

33x100 Parlak / Glossy K928901R0001VTS0



Gri / Grey

33x100 Parlak / Glossy K928890R0001VTS0



Sand / Sand

33x100 Parlak / Glossy K928886R0001VTS0



Panel Dekor / Panel Decor
Sand / Sand

33x100 Sand / Sand Parlak / Glossy K928912R0001VTS0
33x100 Gri / Grey Parlak / Glossy K928923R0001VTS0
33x100 Vizon / Mink Parlak / Glossy K928934R0001VTS0

Porselen Karolar / Porcelain Tiles



Sand / Sand

60x60	Sand / Sand	FLPR	K928971FLPR1VTEO
60x60	Gri / Grey	FLPR	K928982FLPR1VTEO
60x60	Vizon / Mink	FLPR	K928993FLPR1VTEO



BERN



Yer Karoları / Floor Tiles : K946221R0001VTE0 60x60 Bern Koyu Gri / Dark Grey

Duvar Karoları / Wall Tiles : K947049R0001VTS0 40x80 Bern Gri / Grey
K947050R0001VTS0 40x80 Bern Koyu Gri / Dark Grey
K947051R0001VTS0 40x80 Bern Gri Dekor / Grey Decor

PRO

NATURE

BERN

Klasik mermer görünümünü modern tasarımın güncel çizgileriyle yeniden yorumlayan seramik serisi. Organik tasarımın doğal akışkanlığını taşıyan dalga efektli ve üç boyutlu dekorlarıyla kullanıldığı mekânlara dinamik bir atmosfer kazandırıyor. Gri tonlarının modern soğukluğunu hareketli dekorlarının canlılığıyla dengeleyen koleksiyon, 40x80 ebatların yatay, dikey ve karışık kullanımıyla zengin döşeme seçenekleri sunuyor.

A tile series that reinterprets classical look of marble, with contemporary lines of modern design. The collection adds a dynamic atmosphere to the spaces it is used, thanks to its wave-effect and 3D decors which reflect fluid naturality of organic design. Balancing the modern coolness of grey tones with vibrancy of wavy decors, the collection offers rich tiling options, with horizontal, vertical and mixed use of 40 by 80 tiles.

Duvar Karoları / Wall Tiles

Yüzey Alternatifleri / Surface Alternatives
Parlak / Glossy

**Fon ve Dekor Ebatları /
Basic and Decor Tile Sizes**
40x80 cm (R 397x797 mm)

**Fon ve Dekor Renkleri /
Basic Tile and Decor Colors**
Gri / Grey
Koyu Gri / Dark Grey

Kullanım Alanları / Usage Areas
Konut / Residential

Döşeme Alanları / Tiling Areas
Duvar / Wall

Dona Dayanım / Frost Resistance
Yok / Not Available

Baskı Teknolojisi / Printing Technology
RealLook

Ürün Standardı / Product Standard
EN14411 Group BIII

Dip Notlar / Footnotes
H R



Duvar Karosu
Wall Tile



Konut
Residential



Desen Farklılaşması
Shade Variation



Rektifiyeli
Rectified



Parlak
Glossy

Porselen Karolar / Porcelain Tiles

Bünye / Body Type

Seramik Yer Karosu / Ceramic Floor Tiles)

Yüzey Alternatifleri / Surface Alternatives

Parlak / Glossy

Fon Ebatları / Basic Tile Sizes

60x60 cm (R 592x592 mm)

Fon Renkleri / Basic Tile Colors

Gri / Grey

Koyu Gri / Dark Grey

Kullanım Alanları / Usage Areas

Konut / Residential

Döşeme Alanları / Tiling Areas

Duvar / Wall

Yer / Floor

Dona Dayanım / Frost Resistance

Var / Available

Desen Farklılaşması / Shade Variation Classification

V2

Baskı Teknolojisi / Printing Technology

ReaLook

Ürün Standardı / Product Standard

EN14411 Group B1a



Porselen
Porcelain



Yer Karosu
Floor Tile



Duvar Karosu
Wall Tile



Konut
Residential



Dona Dayanım
Frost Resistance



Desen Farklılaşması
Shade Variation



Rektifiyeli
Rectified



Parlak
Glossy

BERN

Duvar Karoları / Wall Tiles



40x80 Parlak / Glossy K947049R0001VTS0

Gri / Grey



40x80 Parlak / Glossy K947050R0001VTS0

Koyu Gri / Dark Grey



40x80 Parlak / Glossy K947051R0001VTS0

Dekor / Decor
Gri / Grey



40x80 Parlak / Glossy K947052R0001VTS0

Dekor / Decor
Koyu Gri / Dark Grey



60X60 FCPR K946220R0001VTE0

Gri / Grey



60X60 FCPR K946221R0001VTE0

Koyu Gri / Dark Grey

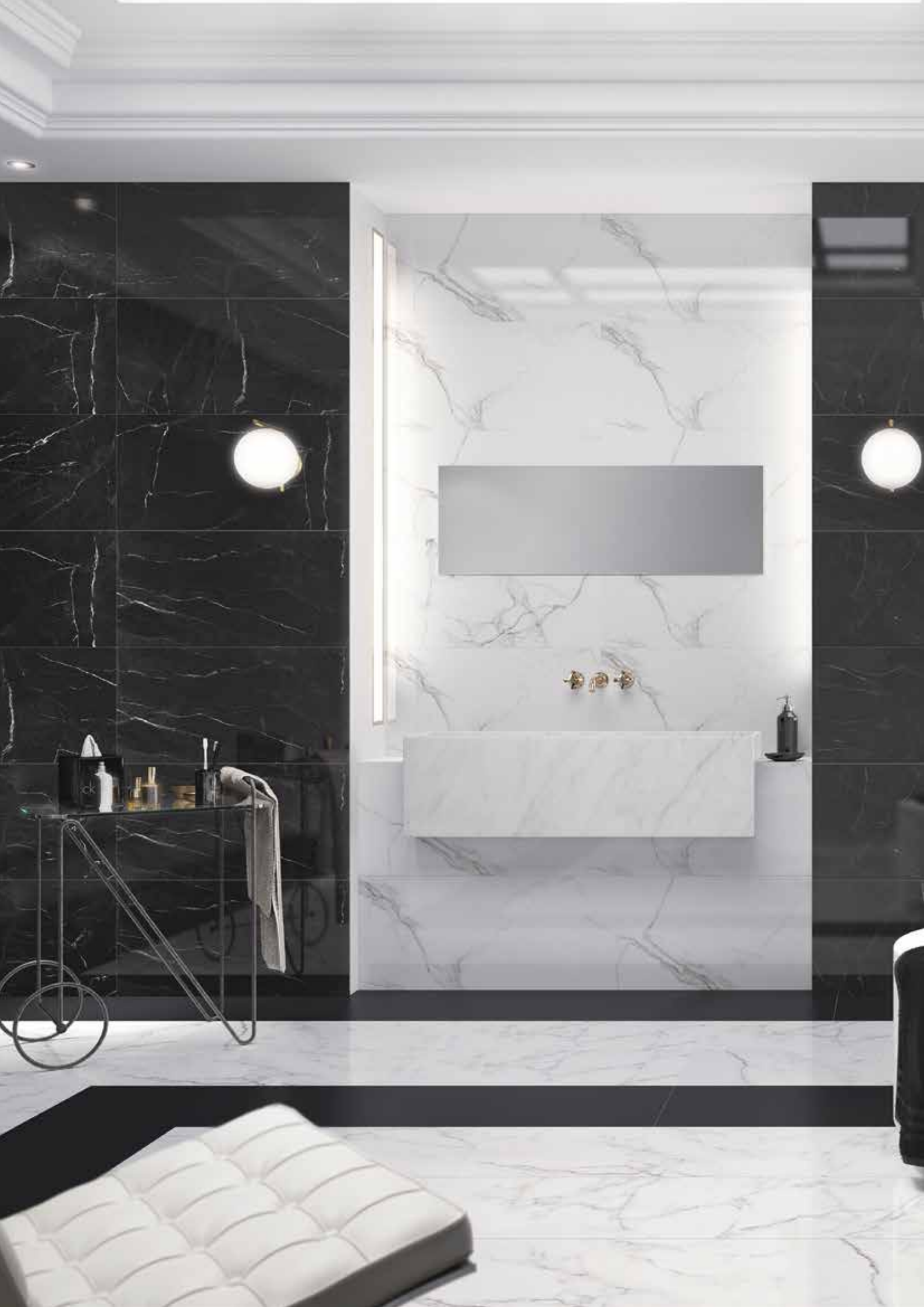

BLACK & WHITE STAR - XL

Duvar Karoları / Wall Tiles : K943661R0001VTS0 40x80 Black & White Star Beyaz / White
K944012R0001VTS0 40x80 Black & White Star Siyah / Black
K944011R0001VTS0 40x80 Black & White Star Dekor / Decor

Yer Karoları / Floor Tiles : K944668R0001VTE0 60x60 Matrix Süper Siyah / Super Black
K943958FLPR1VTE0 60x60 Calacatta Beyaz / White



PRO

NATURE

BLACK & WHITE STAR - XL

Black & White Star ile asaleti çağrıştıran siyah ve beyaz tonlarındaki klasik mermer, modern estetiğin çağdaş yorumuyla yeniden şekilleniyor. 3D Dama dekora sahip Black & White Star duvar karosu serisi, minimalist çizgileriyle tasarımda özgün ve modern bir dünya sunuyor.

In Black & White Star, conventional marble in noble black and white tones is being reshaped with a contemporary interpretation of modern aesthetics. Black & White Star wall tile series with different 3D decor alternatives offers a genuine and modern world by means of its minimalist lines.

Duvar Karoları / Wall Tiles

Yüzey Alternatifleri / Surface Alternatives
Parlak / Glossy

Fon Ebatları / Basic Tile Sizes
25x70 cm (R 247x697 mm)

Dekor Ebatları / Decor Sizes
25x70 cm (R 247x697 mm)

Fon ve Dekor Renkleri / Basic Tile & Decor Colors
Beyaz / White
Siyah / Black

Uyumlu Yer Karoları / Compatible Floor Tiles
Calacatta
Woodmix

Kullanım Alanları / Usage Areas
Konut / Residential

Döşeme Alanları / Tiling Areas
Duvar / Wall

Dona Dayanım / Frost Resistance
Yok / Not Available

**Desen Farklılaşması /
Shade Variation Classification**
V3

Baskı Teknolojisi / Printing Technology
ReaLook

Ürün Standardı / Product Standard
EN14411 Group BIII

Dip Notlar / Footnotes

B H R



Porcelain
Porcelain



Yer Karosu
Floor Tile



Duvar Karosu
Wall Tile



Dekor
Printing



Konut
Residential



Dona Dayanım
Frost Resistance



Full
Lappato



Rektifiyeli
Rectified



Desen Farklılaşması
Shade Variation

BLACK & WHITE STAR - XL

Duvar Karoları / Wall Tiles



Beyaz / White

40x80

Parlak / Glossy

K943661R0001VTE0



Siyah / Black

40x80

Parlak / Glossy

K944012R0001VTE0



Dama Beyaz-Siyah Dekor / Drafts White-Black Decor
Beyaz / White

40x80

Parlak / Glossy

K944011R0001VTE0





Duvar Karoları / Wall Tiles : K945178R0001VTE0 25x70 Black & White Star - L Beyaz / White
K945179R0001VTE0 25x70 Black & White Star - L Dekor / Decor Beyaz / White
K945180R0001VTE0 25x70 Black & White Star - L Siyah / Black

**BLACK & WHITE
STAR - L**





PRO

NATURE

BLACK & WHITE STAR - L

Black & White Star ile asaleti çağrıştıran siyah ve beyaz tonlarındaki klasik mermer, modern estetiğin çağdaş yorumuyla yeniden şekilleniyor. Dalgalı 3D dekora sahip Black & White Star duvar karosu serisi, minimalist çizgileriyle tasarımda özgün ve modern bir dünya sunuyor.

In Black & White Star, conventional marble in noble black and white tones is being reshaped with a contemporary interpretation of modern aesthetics. Black & White Star wall tile series with different 3D decor alternatives offers a genuine and modern world by means of its minimalist lines.

Duvar Karoları / Wall Tiles

Yüzey Alternatifleri / Surface Alternatives

Parlak / Glossy

Fon Ebatları / Basic Tile Sizes

25x70 cm (R 247x697 mm)

Dekor Ebatları / Decor Sizes

25x70 cm (R 247x697 mm)

Fon ve Dekor Renkleri / Basic Tile and Decor Colors

Beyaz / White

Siyah / Black

Uyumlu Yer Karoları / Compatible Floor Tiles

Calacatta

Woodmix

Piccadilly

Kullanım Alanları / Usage Areas

Konut / Residential

Döşeme Alanları / Tiling Areas

Duvar / Wall

Dona Dayanım / Frost Resistance

Yok / Not Available

Desen Farklılaşması / Shade Variation Classification

V3

Baskı Teknolojisi / Printing Technology

ReaLook

Ürün Standardı / Product Standard

EN14411 Group BIII

Dip Notlar / Footnotes

H B R



Duvar Karosu
Wall Tile



Konut
Residential



Desen Farklılaşması
Shade Variation



Rektifiyeli
Rectified



Parlak
Glossy

BLACK & WHITE STAR - L

Duvar Karoları / Wall Tiles



25x70

Parlak / Glossy

K945178R0001VTE0

Beyaz / White



25x70

Parlak / Glossy

K945179R0001VTE0

Dekor / Decor
Beyaz / White

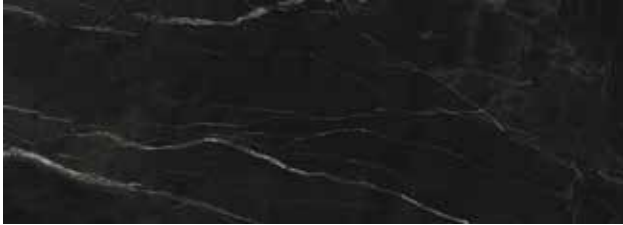

25x70

Parlak / Glossy

K945180R0001VTE0

Siyah / Black

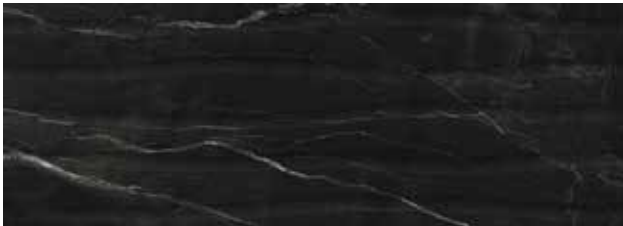

25x70

Parlak / Glossy

K945181R0001VTE0

Dekor / Decor
Siyah / Black



3x70

Mat / Matt

K080715R0001VTE0

Gümüş Bordür / Silver Border



3x70

Parlak / Glossy

K080494R0001VTE0

Gümüş Bordür / Silver Border





Yer Karoları / Floor Tiles : K945077LPR01VTE0 60x60 Opaline Krem / Cream

Duvar Karoları / Wall Tiles : K945051R0001VTE0 25x70 Opaline Krem / Cream
K945057R0001VTE0 25x70 Opaline Altın Dekor Krem / Gold Decor Cream
K945080R0001VTE0 25x70 Opaline Çizgi Dekor Krem / Lines Decor Cream
K945053R0001VTE0 25x70 Opaline 3D Dekor Krem / 3D Decor Cream
K357014R0001VTE0 5x70 Opaline Altın Bordür Krem / Gold Border Cream

OPALINE



PRO

NATURE

OPALINE

Agatha mermerinin doğal güzelliğini platin ve altın detayların zengin ihtişamı ile buluşturan seramik serisi. Altıgen ve rölyefli dekorların geometrik tekrarı, seriye modern bir dokunuş kazandırıyor mermer dokulu parlak yüzeyi, kullanıldığı mekanları aydınlatıyor.

Ceramic series which blend natural beauty of Agatha marble with rich flamboyance of platinum and golden details. Geometrical repetition of hexagonal and relief decors, brings a modern touch to the series. Its marble-textured shiny surface, illuminates spaces in which it is used.

Duvar Karoları / Wall Tiles

Fon Ebatları / Basic Tile Sizes
25x70 cm (R 247x697 mm)

Dekor ve Bordür Ebatları / Decor and Border Sizes
25x70 cm (R 247x697 mm)
5x70 cm (Bordür / Border)

Yüzey Alternatifleri / Surface Alternatives
Parlak / Glossy

Fon ve Dekor Renkleri / Basic Tile and Decor Colors
Gri / Grey
Krem / Cream

Kullanım Alanları / Usage Areas
Konut / Residential
Ticari Alan / Commercial

Döşeme Alanları / Tiling Areas
Duvar / Wall

Dona Dayanım / Frost Resistance
Yok / Not Available

Baskı Teknolojisi / Printing Technology
ReaLook

Ürün Standardı / Product Standard
EN14411 Group BIII

Dip Notlar / Footnotes
H B R



Duvar Karosu
Wall Tile



Ticari Alan
Commercial



Konut
Residential



Parlak
Glossy



Rektifiyeli
Rectified



Desen Farklılaşması
Shade Variation



DEKOR
PRINTING

Porselen ve Seramik Karolar / Porcelain and Ceramic Tiles

Bünye / Body Type

Sırlı Porselen / Glazed Porcelain
Seramik Yer Karosu / Ceramic Floor Tiles

Yüzey Alternatifleri / Surface Alternatives

LPR
Parlak / Glossy

Fon Ebatları / Basic Tile Sizes

60x60 cm (592x592 mm) FCPR
60x60 cm (597x597 mm) LPR

Fon Renkleri / Decor Colors

Gri / Grey
Krem / Cream

Kullanım Alanları / Usage Areas

Konut / Residential

Döşeme Alanları / Tiling Areas

Yer / Floor
Duvar / Wall

Dona Dayanım / Frost Resistance

Var / Available

Desen Farklılaşması / Shade Variation Classification

V3

Baskı Teknolojisi / Printing Technology

ReaLook

Ürün Standardı / Product Standard

EN14411 Group B1a
EN14411 Group B11a

Dip Notlar / Footnotes

H



Porselen
Porcelain



Yer Karosu
Floor Tile



Duvar Karosu
Wall Tile



Konut
Residential



Dona Dayanım
Frost Resistance



Desen Farklılaşması
Shade Variation



Lappato



Rektifiyeli
Rectified



Parlak
Glossy

OPALINE

Duvar Karoları / Wall Tiles



25x70 Parlak / Glossy K945051R0001VTE0

Krem / Cream



25x70 Parlak / Glossy K945055R0001VTE0

Petek Dekor / Honeycomb Decor
Krem / Cream



25x70 Parlak / Glossy K945080R0001VTE0

Çizgi Dekor / Lines Decor
Krem / Cream



25x70 Parlak / Glossy K945053R0001VTE0

3D Dekor / 3D Decor
Krem / Cream



25x70 Parlak / Glossy K945057R0001VTE0

Altın Dekor / Gold Decor
Krem / Cream



5x70 Parlak / Glossy K357014R0001VTE0

Altın Bordür / Gold Border
Krem / Cream



60x60 LPR
K945077LPR01VTE0

60x60 FCPR
K357012R0001VTE0

Krem / Cream



25x70 Parlak / Glossy

K945052R0001VTE0

Gri / Grey



25x70 Parlak / Glossy

K945056R0001VTE0

Petek Dekor / Honeycomb Decor
Gri / Grey



25x70 Parlak / Glossy

K945081R0001VTE0

Çizgi Dekor / Lines Decor
Gri / Grey



25x70 Parlak / Glossy

K945054R0001VTE0

3D Dekor / 3D Decor
Gri / Grey

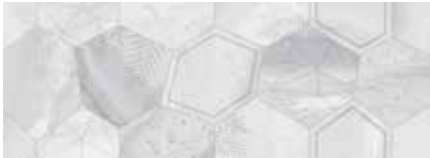

25x70 Parlak / Glossy

K945058R0001VTE0

Platin Dekor / Platin Decor
Gri / Grey



5x70 Parlak / Glossy

K357015R0001VTE0

Platin Bordür / Platin Border
Gri / Grey



60x60 LPR
K945076LPR01VTE0

60x60 FCPR
K357011R0001VTE0

Gri / Grey



TUNDRA SKY



Yer Karoları / Floor Tiles : K945016LPR01VTE0 60x60 Tundra Sky Gri / Grey
922962R0001VTE0 45x90 Piccadilly Gri / Grey

Duvar Karoları / Wall Tiles : K944968R0001VTE0 25x70 Tundra Sky Gri / Grey Parlak / Glossy
K944972R0001VTE0 25x70 Tundra Sky 3D Dekor Gri / 3D Decor Grey Parlak / Glossy
K944970R0001VTE0 25x70 Tundra Sky Beton Beyaz / Cement White

PRO

NATURE

TUNDRA SKY

Tundra grisi mermerin doğal güzelliğini beton dokusunun modern estetiği ile birleştiren seramik serisi. Mat ve parlak yüzeylerin mükemmel uyumu, üç boyutlu yüzeyleri ve dalgalı dekorları ile benzersiz mekânlar yaratmanız için tasarlandı.

Ceramic series which combine natural beauty of tundra grey marble with modern aesthetics of concrete texture. It is designed for creating unique spaces with excellent harmony of matt and glossy surfaces, 3D patterns and wavelike settings.

Duvar Karoları / Wall Tiles

Fon Ebatları / Basic Tile Sizes
25x70 cm (R 247x697 mm)

**Dekor ve Bordür Ebatları /
Decor and Border Sizes**
25x70 cm (R 247x697 mm)
3x70 cm (Bordür / Border)

Yüzey Alternatifleri / Surface Alternatives
Mat / Matt
Parlak / Glossy

**Fon ve Dekor Renkleri /
Basic Tile and Decor Colors**
Beyaz / White
Gri / Grey

Kullanım Alanları / Usage Areas
Konut / Residential
Ticari Alan / Commercial

Döşeme Alanları / Tiling Areas
Duvar / Wall

Dona Dayanım / Frost Resistance
Yok / Not Available

Baskı Teknolojisi / Printing Technology
ReaLook

Ürün Standardı / Product Standard
EN14411 Group BIII

Dip Notlar / Footnotes
H B R



Duvar Karosu
Wall Tile



Ticari Alan
Commercial



Konut
Residential



Mat
Matt



Parlak
Glossy



Rektifiyeli
Rectified



V₃
Desen Farklılaşması
Shade Variation

PRO

NATURE

TUNDRA SKY

Porselen Karolar / Porcelain Tiles

Bünye / Body Type

Sırlı Porselen / Glazed Porcelain
Seramik Yer Karosu / Ceramic Floor Tiles

Yüzey Alternatifleri / Surface Alternatives

LPR
Parlak / Glossy

Fon Ebatları / Basic Tile Sizes

60x60 cm (592x592 mm) FCPR
60X60 cm (597x597 mm) LPR

Fon Renkleri / Decor Colors

Gri / Grey

Kullanım Alanları / Usage Areas

Konut / Residential

Döşeme Alanları / Tiling Areas

Yer / Floor
Duvar / Wall

Dona Dayanım / Frost Resistance

Var / Available

Desen Farklılaşması / Shade Variation Classification

V3

Baskı Teknolojisi / Printing Technology

ReaLook

Ürün Standardı / Product Standard

EN14411 Group Bla
EN14411 Group Blla

Dip Notlar / Footnotes

H



Porselen
Porcelain



Yer Karosu
Floor Tile



Duvar Karosu
Wall Tile



Konut
Residential



Ticari Alan
Commercial



Dona Dayanım
Frost Resistance



Desen Farklılaşması
Shade Variation



Lappato



Rektifiyeli
Rectified



Parlak
Glossy

TUNDRA SKY

Duvar Karoları / Wall Tiles

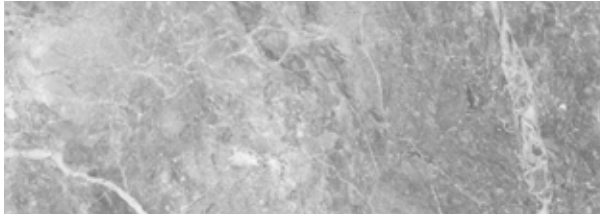

25x70 Parlak / Glossy K944968R0001VTE0

Gri / Grey

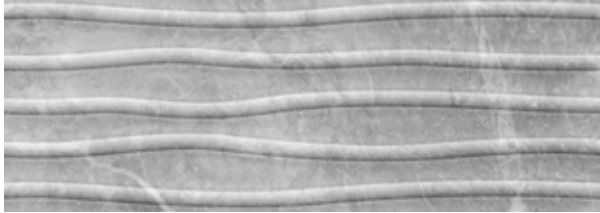

25x70 Parlak / Glossy K944972R0001VTE0

3D Dekor / 3D Decor
Gri / Grey



25x70 Mat / Matt K944969R0001VTE0

Gri / Grey

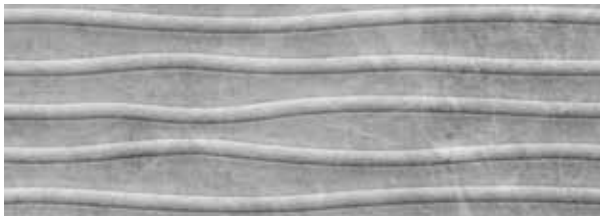

25x70 Mat / Matt K944973R0001VTE0

3D Dekor / 3D Decor
Gri / Grey

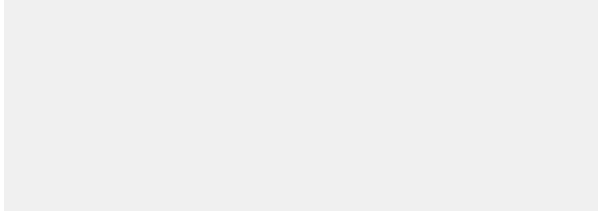

25x70 Parlak / Glossy K944971R0001VTE0

Düz Beyaz / Plain White

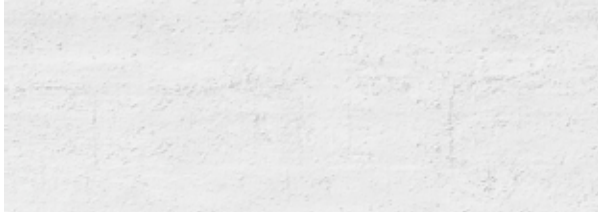

25x70 Mat / Matt K944970R0001VTE0

Beton Beyaz - Cement White



3x70 Mat / Matt K080715R0001VTE0

Gümüş Bordür / Silver Border



3x70 Parlak / Glossy K080494R0001VTE0

Gümüş Bordür / Silver Border

Porselen Karolar / Porcelain Tiles

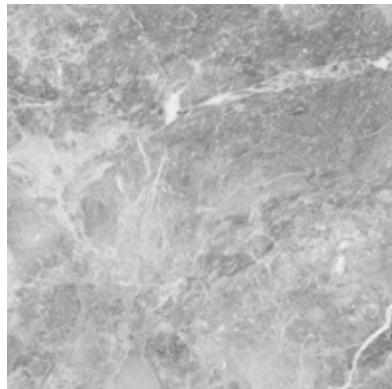

60x60 LPR K945016LPR01VTE0

60x60 FCPR K357007R0001VTE0

Gri / Grey



ATTRACTION

Yer Karoları / Floor Tiles : K932213LPR01VTE0 60x60 Attraction Beyaz / White

Duvar Karoları / Wall Tiles : K920210R0001VTE0 25x70 Attraction Beyaz / White
K920232R0001VTE0 25x70 Attraction Dekor Beyaz / Decor White
K080494R0001VTE0 3x70 Gümüş Çubuk Bordür / Silver Border

PRO

NATURE

ATTRACTION

Dünyada ender rastlanan İtalyan Calacatta mermeriyle hayat bulan seramik serisi. Attraction, sadeliğin ihtişamını tüm doğallığıyla mekânlara yansıtırken petek dokulu rölyeflerin iç ve dış bükey olarak değişen yapısıyla da mekâna dinamizm kazandırıyor.

A ceramic series designed with Italian Calacatta marble, one of the rarest types in the world. Reflecting the magnificence of simplicity in a quite natural way, Attraction adds dynamism to spaces with variable concave and convex structure of honeycomb reliefs.

Duvar Karoları / Wall Tiles

Yüzey Alternatifleri / Surface Alternatives
Parlak / Glossy

**Fon ve Dekor Ebatları /
Basic Tile and Decor Sizes**
25x70 cm (R 247x697 mm)

**Fon ve Dekor Renkleri /
Basic Tile and Decor Colors**
Beyaz / White

Kullanım Alanları / Usage Areas
Konut / Residential

Döşeme Alanları / Tiling Areas
Duvar / Wall

Dona Dayanım / Frost Resistance
Yok / Not Available

Baskı Teknolojisi / Printing Technology
ReaLook

Ürün Standardı / Product Standard
EN14411 Group BIII

Dip Notlar / Footnotes

H R



Duvar Karosu
Wall Tile



Konut
Residential



Rektifiyeli
Rectified



Parlak
Glossy

Porselen Karolar / Porcelain Tiles

Bünye / Body Type

Sırlı Porselen / Glazed Porcelain
Seramik Yer Karosu / Ceramic Floor Tiles

Yüzey Alternatifleri / Surface Alternatives

LPR
Parlak / Glossy

Fon Ebatları / Basic Tile Sizes

60x60 cm (592x592 mm) FCPR
60X60 cm (597x597 mm) LPR

Fon Renkleri / Basic Tile Colors

Beyaz / White

Kullanım Alanları / Usage Areas

Konut / Residential

Döşeme Alanları / Tiling Areas

Yer / Floor
Duvar / Wall

Dona Dayanım / Frost Resistance

Var / Available

Desen Farklılaşması /

Shade Variation Classification
V3

Baskı Teknolojisi / Printing Technology

ReaLook

Ürün Standardı / Product Standard

EN14411 Group B1a
EN14411 Group B1a

Dip Notlar / Footnotes

H



Porselen
Porcelain



Yer Karosu
Floor Tile



Duvar Karosu
Wall Tile



Konut
Residential



Dona Dayanım
Frost Resistance



Desen Farklılaşması
Shade Variation



Lappato



Rektifiyeli
Rectified



Parlak
Glossy

ATTRACTION



25x70

Parlak / Glossy

K920210R0001VTE0

Beyaz / White



25x70

Parlak / Glossy

K920232R0001VTE0

Dekor / Decor
Beyaz / White



3x70

Parlak / Glossy

K080494R0001VTE0

Çubuk Bordür / Stick Border
Gümüş / Silver



3x70

Mat / Matt

K080715R0001VTE0

Çubuk Bordür / Stick Border
Gümüş / Silver

Porselen Karolar / Porcelain Tiles



60x60
60x60

LPR
FCPR

K932213LPR01VTE0
K945028R0001VTE0

Beyaz / White



Yer Karoları / Floor Tiles : K920265FLPR1VTE0 60x60 Celebration Krem / Cream

Duvar Karoları / Wall Tiles : K920184R0001VTE0 25x70 Celebration Vizon / Mink
K080472R0001VTE0 25x70 Celebration Dekor 1 / Decor 1 Altın / Gold

CELEBRATION



PRO

NATURE

CELEBRATION

Tutkulu mekânlar yaratmak için gereken tüm detayları deseninde taşıyan parlak yüzeyli seramik serisi. Celebration, mermer görünümlü yüzeyi ile mekânlara canlılık getirirken, üç boyutlu rölyefli dekorlarıyla da duvarlarda hareketlilik sağlıyor.

A ceramic series with glossy surface embodying all the details required for creating spaces full of passion. Celebration adds liveliness to spaces with its marble-like polished surface while fostering the dynamism of walls with three dimensional relief decors.

Duvar Karoları / Wall Tiles

Yüzey Alternatifleri / Surface Alternatives
Parlak / Glossy

Fon ve Dekor Ebatları / Basic Tile and Decor Sizes
25x70 cm (R 247x697 mm)
3x70 cm

Fon Renkleri / Basic Tile Colors
Krem / Cream
Antrasit / Anthracite
Vizon / Mink

Dekor Renkleri / Basic Decor Colors
Beyaz / White
Altın / Gold
Vizon / Mink

Kullanım Alanları / Usage Areas
Konut / Residential

Döşeme Alanları / Tiling Areas
Duvar / Wall

Dona Dayanım / Frost Resistance
Yok / Not Available

Baskı Teknolojisi / Printing Technology
ReaLook

Ürün Standardı / Product Standard
EN14411 Group BIII

Dip Notlar / Footnotes

B H R



Duvar Karosu
Wall Tile



Konut
Residential



Rektifiyeli
Rectified



Parlak
Glossy



Dekor
Printing

PRO

NATURE

CELEBRATION

Porselen Karolar / Porcelain Tiles

Bünye / Body Type

Sırlı Porselen / Glazed Porcelain
Seramik Yer Karosu / Ceramic Floor Tiles

Yüzey Alternatifleri / Surface Alternatives

LPR
Parlak / Glossy

Fon Ebatları / Basic Tile Sizes

60x60 cm (592x592 mm) FCPR
60X60 cm (597x597 mm) LPR

Fon Renkleri / Basic Tile Colors

Krem / Cream
Vizon / Mink
Antrasit / Anthracite

Kullanım Alanları / Usage Areas

Konut / Residential

Döşeme Alanları / Tiling Areas

Yer / Floor
Duvar / Wall

Dona Dayanım / Frost Resistance

Var / Available

Desen Farklılaşması / Shade Variation Classification

V3

Baskı Teknolojisi / Printing Technology

ReaLook

Ürün Standardı / Product Standard

EN14411 Group Bla
EN14411 Group Blla

Dip Notlar / Footnotes

H



Porselen
Porcelain



Yer Karosu
Floor Tile



Duvar Karosu
Wall Tile



Konut
Residential



Parlak
Glossy



Dona Dayanım
Frost Resistance



V3
Desen Farklılaşması
Shade Variation



Lappato



Full
Lappato



Rektifiyeli
Rectified

CELEBRATION

Duvar Karoları / Wall Tiles



25x70 Parlak / Glossy K920206R0001VTE0

Krem / Cream



25x70 Parlak / Glossy K920184R0001VTE0

Vizon / Mink



25x70 Parlak / Glossy K920173R0001VTE0

Antrasit / Anthracite



25x70 Parlak / Glossy K920862R0001VTE0

Dekor 1 / Decor 1
Vizon / Mink



3x70 Parlak / Glossy K080494R0001VTE0

Çubuk Bordür / Stick Border
Gümüş / Silver



3x70 Mat / Matt K080715R0001VTE0

Çubuk Bordür / Stick Border
Gümüş / Silver



25x70 Parlak / Glossy K080472R0001VTEo

Dekor 1 / Decor 1
Altın / Gold



25x70 Parlak / Glossy K920873R0001VTEo

Çizgili Dekor 2 / Lines Decor 2
Vizon / Mink

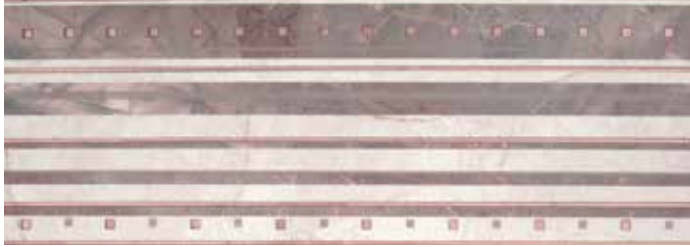

25x70 Parlak / Glossy K080483R0001VTEo

Çizgili Dekor 2 / Lines Decor 2
Altın / Gold

Porselen Karolar / Porcelain Tiles



60x60	Krem / Cream	LPR	K932224LPR01VTEo
60x60	Vizon / Mink	LPR	K933871LPR01VTEo
60x60	Krem / Cream	FLPR	K920265FLPR1VTEo
60x60	Krem / Cream	FCPR	K945027R0001VTEo
60x60	Vizon / Mink	FCPR	K945026R0001VTEo

Krem / Cream



VERSUS - M

Yer Karoları / Floor Tiles : K945029R0001VTE0 60x60 Versus - M Beyaz / White

Duvar Karoları / Wall Tiles : K941243R0001VTE0 30x60 Versus - M Beyaz / White
K941280R0001VTE0 30x60 Versus - M Beyaz Dalga Dekor / White Wave Decor

PRO

NATURE

VERSUS - M

Silver fantasy mermerini, doğalına en yakın tonlarıyla mekânlara yansıtan yeni seramik serisi. Duvar seramiklerinin yanı sıra aynı tasarım dilinde porselenlere de sahip Versus, zıtlıklardan besleniyor; döşendiği her ortamda minimal ve modern bir algı yaratıyor. Soğuk mermer dokusunun bronz renkteki parlak paslanmaz metal çubuklarla yarattığı zıtlık, duvarlara yepyeni bir görünüm kazandırıyor.

A new ceramic series using silver fantasy marble with hues which are closest to its natural color. Presented with porcelain tiles in addition to its wall tiles, Versus is enriched with contrasts creating a sense of minimalism and modernity in all spaces. The contrast created by the cool marble tissue with glossy stainless steel bars of bronze color gives a brand new outlook to walls.

Duvar Karoları / Wall Tiles

Yüzey Alternatifleri / Surface Alternatives

Parlak / Glossy

Fon Ebatları / Basic Tile Sizes

30x60 cm (R 292x592 mm)

30x60 cm (298x598 mm)

Dekor Ebatları / Decor Sizes

30x60 cm (R 292x592 mm)

30x60 cm (298x598 mm)

Fon ve Dekor Renkleri / Basic Tile and Decor Colors

Beyaz / White

Gri / Grey

Uyumlu Yer Karoları / Compatible Floor Tiles

Versus

Kullanım Alanları / Usage Areas

Konut / Residential

Ticari Alan / Commercial

Döşeme Alanları / Tiling Areas

Duvar / Wall

Dona Dayanım / Frost Resistance

Yok / Not Available

Baskı Teknolojisi / Printing Technology

ReaLook

Ürün Standardı / Product Standard

EN14411 Group BIII

Dip Notlar / Footnotes

H R



Duvar Karosu
Wall Tile



Konut
Residential



Ticari Alan
Commercial



Desen Farklılaşması
Shade Variation



Rektifiyeli
Rectified



Rektifiyesiz
Non Rectified



Parlak
Glossy

Porselen ve Seramik Karolar / Porcelain and Ceramic Tiles

Bünye / Body Type

Sırlı Porselen / Glazed Porcelain
Seramik Yer Karosu / Ceramic Floor Tile

Yüzey Alternatifleri / Surface Alternatives

Mat / Matt
Parlak / Glossy

Fon Ebatları / Basic Tile Sizes

45x45 cm (447x447mm)
60x60 cm (592x592 mm) FCPR

Fon Renkleri / Basic Tile Colors

Beyaz / White
Anthracite / Antrasit

Kullanım Alanları / Usage Areas

Konut / Residential
Ticari Alan / Commercial

Döşeme Alanları / Tiling Areas

Duvar / Wall
Yer / Floor

Dona Dayanım / Frost Resistance

Var / Available

Desen Farklılaşması / Shade Variation Classification

V3

Baskı Teknolojisi / Printing Technology

ReaLook

Ürün Standardı / Product Standard

EN14411 Group Bla
EN14411 Group Blla



Porselen
Porcelain



Yer Karosu
Floor Tile



Konut
Residential



Parlak
Glossy



Dona Dayanım
Frost Resistance



V3
Desen Farklılaşması
Shade Variation



Mat
Matt



Rektifiyesiz
Non Rectified

VERSUS - M

Duvar Karoları / Wall Tiles



Beyaz / White

30x60
30x60

Parlak / Glossy
Parlak / Glossy

K941243R0001VTE0
K94124300001VTE0



Gri / Grey

30x60
30x60

Parlak / Glossy
Parlak / Glossy

K941254R0001VTE0
K94125400001VTE0



Dalga Dekor / Wave Decor
Beyaz / White

30x60
30x60

Parlak / Glossy
Parlak / Glossy

K941280R0001VTE0
K94128000001VTE0

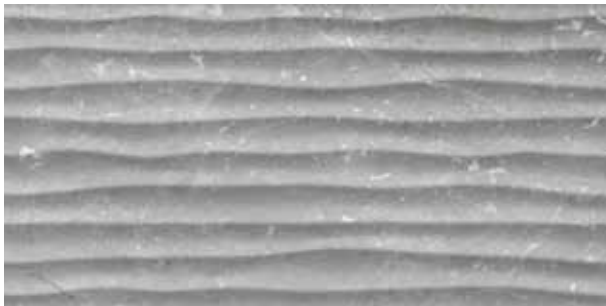

Dalga Dekor / Wave Decor
Gri / Grey

30x60
30x60

Parlak / Glossy
Parlak / Glossy

K941291R0001VTE0
K94129100001VTE0



30x60 Parlak / Glossy K94316900001VTE0

Süpürgelik / Plinth
Beyaz / White



30x60 Parlak / Glossy K94317100001VTE0

Süpürgelik / Plinth
Gri / Grey

Porselen Karolar / Floor Tiles



60x60 FCPR K945029R0001VTE0
45x45 K94526400001VTE0

Beyaz / White

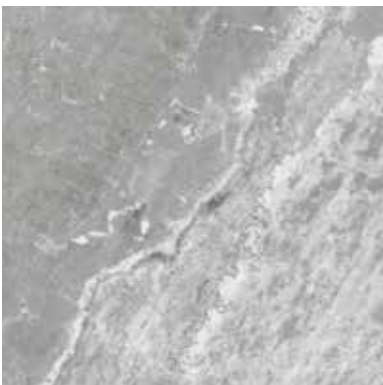

60x60 FCPR K945030R0001VTE0
45x45 K94526500001VTE0

Antrasit / Anthracite



Yer Karoları / Floor Tiles : K357021R0001VTE0 60x60 Inside - M Kum Beji / Sand

Duvar Karoları / Wall Tiles : K94457200001VTE0 30x60 Inside - M Kum Beji / Sand
K94519600001VTE0 30x60 Inside - M Kum Beji Dekor / Sand Decor

INSIDE - M



PRO

NATURE

INSIDE - M

Madrid şehrinden ilham alınarak dünyaca ünlü İspanyol mermeri Emprador'un dokusu ile tasarlanan seramik serisi. Inside, yoğun damarlı yapısı ve doğal renkleriyle mekânlarda ihtişamlı bir atmosfer yaratıyor. Seriyi tamamlayan dekoru, mermerin asaletini, eski çağlardan kalma görünümü dev floral deseniyle duvarlara taşıyor.

A ceramic series reflecting the texture of world famous spanish marble Emprador with inspiration from Madrid, Inside creates a magnificent atmosphere with its intense venous structure and natural colors. Its decor complementing the series brings the noble character of marble to walls with gigantic floral pattern reminding one of the ancient times.

Duvar Karoları / Wall Tiles

Yüzey Alternatifleri / Surface Alternatives
Parlak / Glossy

Fon Ebatları / Basic Tile Sizes
30x60 cm (R 298x598 mm)

Dekor Ebatları / Decor Sizes
30x60 cm (R 298x598 mm)

**Fon ve Dekor Renkleri /
Basic Tile and Decor Colors**
Kum Beji / Sand
Gri / Grey

**Uyumlu Yer Karoları /
Compatible Floor Tiles**
Inside

Kullanım Alanları / Usage Areas
Konut / Residential
Ticari Alan / Commercial

Döşeme Alanları / Tiling Areas
Duvar / Wall

**Desen Farklılaşması /
Shade Variation Classification**
V3

Dona Dayanım / Frost Resistance
Yok / Not Available

Baskı Teknolojisi / Printing Technology
ReaLook

Ürün Standardı / Product Standard
EN14411 Group BIII

Dip Notlar / Footnotes

H R



Duvar Karosu
Wall Tile



Konut
Residential



Desen Farklılaşması
Shade Variation



Rektifiyeli
Rectified



Rektifiyesiz
Non Rectified



Parlak
Glossy

Seramik Karolar / Ceramic Tiles

Bünye / Body Type

Seramik Yer Karosu / Ceramic Floor Tile

Yüzey Alternatifleri / Surface Alternatives

Parlak / Glossy

Fon Ebatları / Basic Tile Sizes

60x60 cm (592x592 mm) FCPR

Fon Renkleri / Basic Tile Colors

Kum Beji / Sand

Gri / Grey

Vizon / Mink

Kullanım Alanları / Usage Areas

Konut / Residential

Ticari Alan / Commercial

Döşeme Alanları / Tiling Areas

Duvar / Wall

Yer / Floor

Dona Dayanım / Frost Resistance

Var / Available

Desen Farklılaşması /

Shade Variation Classification

V3

Baskı Teknolojisi / Printing Technology

ReaLook

Ürün Standardı / Product Standard

EN14411 Group BIIa

H R



Porselen
Porcelain



Yer Karosu
Floor Tile



Konut
Residential



V3
Desen Farklılaşması
Shade Variation



Dona Dayanım
Frost Resistance



Parlak
Glossy



Rektifiyesiz
Non Rectified

INSIDE - M

Duvar Karoları / Wall Tiles



Sand

30x60

Parlak / Glossy

K94457200001VTE0



Gri / Grey

30x60

Parlak / Glossy

K94519300001VTE0



Dekor / Decor
Sand

30x60

Parlak / Glossy

K94519600001VTE0



Dekor / Decor
Gri / Grey

30x60

Parlak / Glossy

K94519400001VTE0



60x60 Parlak / Glossy K357021R0001VTE0

Sand



60x60 Parlak / Glossy K357022R0001VTE0

Gri / Grey



60x60 Parlak / Glossy K357026R0001VTE0

Vizon / Mink



Yer Karoları / Floor Tiles : K357025R0001VTE0 60x60 Eccentric - M Kemik / Bone

Duvar Karoları / Wall Tiles : K945166R0001VTE0 30x60 Eccentric - M Kemik / Bone
K945169R0001VTE0 30x60 Eccentric - M Kemik Dekor / Bone Decor

ECCENTRIC - M



PRO

NATURE

ECENTRIC - M

Otantik ve yarı değerli agatha taşının güzelliğinden ilham alan yeni seramik serisi. Eccentric, geçmişten günümüze süs eşyası yapımında kullanılan bu değerli taş görünümüyle evlere bir mücevher gibi ışıltı katıyor. Üç boyutlu rölyefli dekoru ile tamamlanan seri mekanları göz alıcı bir güzelliğe kavuşturuyor.

A new ceramic series inspired by authentic and semi-precious agate stone. Eccentric adds gleam to residences like a jewel with the outlook of this precious stone which is traditionally used for making ornaments. Complemented with three dimensional relief decor, the series adds extraordinary beauty to spaces.

Duvar Karoları / Wall Tiles

Yüze Alternatifleri / Surface Alternatives

Parlak / Glossy

Fon Ebatları / Basic Tile Sizes

30x60 cm (R 292x592 mm)

Dekor Ebatları / Decor Sizes

30x60 cm (R 292x592 mm)

Fon ve Dekor Renkleri / Basic Tile and Decor Colors

Beyaz / White

Gri / Grey

Kemik / Bone

Uyumlu Yer Karoları / Compatible Floor Tiles

Samba

Kullanım Alanları / Usage Areas

Konut / Residential

Ticari Alan / Commercial

Döşeme Alanları / Tiling Areas

Duvar / Wall

Dona Dayanım / Frost Resistance

Yok / Not Available

Baskı Teknolojisi / Printing Technology

ReaLook

Ürün Standardı / Product Standard

EN14411 Group BIII

Dip Notlar / Footnotes

H R



Duvar Karosu
Wall Tile



Konut
Residential



Ticari Alan
Commercial



Desen Farklılaşması
Shade Variation



Rektifiyeli
Rectified



Parlak
Glossy

Seramik Karolar / Ceramic Tiles

Bünye / Body Type

Seramik Yer Karosu / Ceramic Floor Tile

Yüzey Alternatifleri / Surface Alternatives

Parlak / Glossy

Fon Ebatları / Basic Tile Sizes

60x60 cm (592x592 mm) FCPR

Fon Renkleri / Basic Tile Colors

Beyaz / White

Gri / Grey

Kemik / Bone

Kullanım Alanları / Usage Areas

Konut / Residential

Ticari Alan / Commercial

Döşeme Alanları / Tiling Areas

Duvar / Wall

Yer / Floor

Dona Dayanım / Frost Resistance

Var / Available

Desen Farklılaşması / Shade Variation Classification

V3

Baskı Teknolojisi / Printing Technology

ReaLook

Ürün Standardı / Product Standard

EN14411 Group B1a



Porselen
Porcelain



Yer Karosu
Floor Tile



Konut
Residential



Dona Dayanım
Frost Resistance



V3
Desen Farklılaşması
Shade Variation



Rektifiyeli
Rectified



Parlak
Glossy

ECCENTRIC - M

Duvar Karoları / Wall Tiles



Beyaz / White

30x60 Parlak / Glossy K945165R0001VTE0



Kemik / Bone

30x60 Parlak / Glossy K945166R0001VTE0



Gri / Grey

30x60 Parlak / Glossy K945167R0001VTE0



Dekor / Decor
Beyaz / White

30x60 Parlak / Glossy K945168R0001VTE0



Dekor / Decor
Kemik / Bone

30x60 Parlak / Glossy K945169R0001VTE0



Dekor / Decor
Gri / Grey

30x60 Parlak / Glossy K945170R0001VTE0



60x60 FCPR

K357023R0001VTE0

Beyaz / White



60x60 FCPR

K357024R0001VTE0

Gri / Grey



60x60 FCPR

K357025R0001VTE0

Kemik / Bone



Yer Karoları / Floor Tiles : K928061LPR01VTE0 60x60 Ethereal - M Açık Gri / Light Grey

Duvar Karoları / Wall Tiles : K92778100001VTE0 30x60 Ethereal - M Açık Gri / Light Grey
K92797600001VTE0 30x60 Ethereal - M Geometrik Mix Dekor / Geometric Mix Decor Gri / Grey
K92805000001VTE0 30x60 Ethereal - M Çizgili Mix Dekor / Lines Mix Decor Gri / Grey

ETHEREAL - M



PRO

NATURE

ETHEREAL - M

Üç boyutlu geometrik desenleri, altın ve gümüş baskılı dekor ve bordür alternatifleriyle yerlerde ve duvarlarda sofistike bir atmosfer yaratan seramik serisi. Doğal mermerin kendi içindeki çeşitliliğinden ilham alan Ethereal, modern geometrik düzenle duvarlara yansıyor. Beş farklı görsellikte tasarlanan seride, bir karo içindeki farklı renk ve desenler aracılığıyla, doğal mermerdeki el işçiliği en ihtişamlı haliyle mekânlara değer katıyor.

A ceramic series creating a sophisticated atmosphere on walls and floors with three dimensional geometrical patterns, golden and silvery decors and borders. Inspired by the intrinsic variety of natural marble, Ethereal embellishes walls with modern geometrical shapes. The series is characterized with a magnificent workmanship on natural marble stone displayed by means of different colors and patterns forming five visual alternatives.

Duvar Karoları / Wall Tiles

Yüzey Alternatifleri / Surface Alternatives
Parlak / Glossy

Fon Ebatları / Basic Tile Sizes
30x60 cm (298x598 mm)

Dekor Ebatları / Basic Decor Sizes
30x60 cm (298x598 mm)

Fon Renkleri / Basic Tile Colors
Açık Bej / Light Beige
Açık Gri / Light Grey
Gri / Grey
Soft Kahve / Soft Brown
Kum Gri / Sand Grey

Kullanım Alanları / Usage Areas
Konut / Residential

Döşeme Alanları / Tiling Areas
Duvar / Wall

Dona Dayanım / Frost Resistance
Yok / Not Available

Desen Farklılaşması / Shade Variation Classification
V3

Baskı Teknolojisi / Printing Technology
ReaLook

Ürün Standardı / Product Standard
EN14411 Group BIII

Dip Notlar / Footnotes

B H



Duvar Karosu
Wall Tile



Konut
Residential



Desen Farklılaşması
Shade Variation



Rektifiyesiz
Non-Rectified



Parlak
Glossy



Dekor
Printing

Porselen ve Seramik Karolar / Porcelain and Ceramic Tiles

Bünye / Body Type

Sırlı Porselen / Glazed Porcelain
Seramik Yer Karoları / Ceramic Floor Tiles

Yüzey Alternatifleri / Surface Alternatives

LPR
Mat / Matt
Parlak / Glossy

Fon Ebatları / Basic Tile Sizes

60x60 cm (R 597x597 mm) LPR
60x60 cm (R 592x592 mm) FCPR
45x45 cm (R 447X447 mm)

Fon Renkleri / Basic Tile Colors

Açık Bej / Light Beige
Açık Gri / Light Grey
Gri / Grey
Soft Kahve / Soft Brown
Kum Gri / Sand Grey

Kullanım Alanları / Usage Areas

Konut / Residential
Ticari Alan (Düşük Trafik) /
Commercial (Low Traffic)

Döşeme Alanları / Tiling Areas

Duvar / Wall
Yer / Floor

Dona Dayanım / Frost Resistance

Var / Available

Desen Farklılaşması / Shade Variation Classification

V3

Baskı Teknolojisi / Printing Technology

RealLook

Ürün Standardı / Product Standard

EN14411 Group B1a
EN14411 Group B11a

Dip Notlar / Footnotes

H P R



Porselen
Porcelain



Yer Karosu
Floor Tile



Duvar Karosu
Wall Tile



Konut
Residential



Parlak
Glossy



Dona Dayanım
Frost Resistance



Desen Farklılaşması
Shade Variation



Rektifiyeli
Rectified



Lappato



Mat
Matt

ETHEREAL - M

Duvar Karoları / Wall Tiles



Açık Bej / Light Beige

30x60 Parlak / Glossy K92781400001VTE0



Açık Gri / Light Grey

30x60 Parlak / Glossy K92778100001VTE0



Gri / Grey

30x60 Parlak / Glossy K92779200001VTE0



Soft Kahve / Soft Brown

30x60 Parlak / Glossy K92782500001VTE0



3D Dekor / 3D Decor
Açık Bej / Light Beige

30x60 Açık Bej / Light Beige Parlak / Glossy K92787300001VTE0
30x60 Açık Gri / Light Grey Parlak / Glossy K92784000001VTE0



Geometrik Mix Dekor / Geometric Mix Decor
Soft Kahve, Açık Bej / Soft Brown, Light Beige

30x60 Soft Kahve, Açık Bej / S. Brown, L. Beige Parlak / Glossy K92796500001VTE0
30x60 Gri / Grey Parlak / Glossy K92797600001VTE0

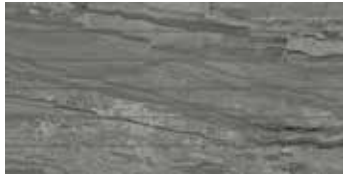

Scored
Açık Gri / Light Grey

30x60 Açık Gri / Light Grey Parlak / Glossy K93969200001VTE0
30x60 Gri / Grey Parlak / Glossy K93962200001VTE0
30x60 Soft Kahve / Soft Brown Parlak / Glossy K93963300001VTE0



Çizgili Mix Dekor / Lines Mix Decor
Soft Kahve, Açık Bej / Soft Brown, Light Beige

30x60
30x60

Soft Kahve, Açık Bej / Soft Brown, Light Beige
Gri / Grey

Parlak / Glossy
Parlak / Glossy

K92804600001VTE0
K92805000001VTE0



Geometrik Dekor / Geometric Decor
Soft Kahve / Soft Brown

30x60
30x60

Soft Kahve / Soft Brown
Açık Bej / Light Beige

Parlak / Glossy
Parlak / Glossy

K92794300001VTE0
K92793200001VTE0



Geometrik Altın Dekor / Geometric Gold Decor
Soft Kahve / Soft Brown

30x60
30x60

Soft Kahve / Soft Brown
Açık Bej / Light Beige

Parlak / Glossy
Parlak / Glossy

K08226600001VTE0
K08225500001VTE0



Geometrik Platin Dekor / Geometric Platin Decor
Gri / Grey

30x60
30x60

Açık Gri / Light Grey
Gri / Grey

Parlak / Glossy
Parlak / Glossy

K08222200001VTE0
K08223300001VTE0



Geometrik Altın Bordür /
Geometric Gold Border
Açık Bej / Light Beige

9x60
9x60

Açık Bej / Light Beige
Kahve / Brown

Parlak / Glossy
Parlak / Glossy

K94434600001VTE0
K94434700001VTE0



Geometrik Platin Bordür /
Geometric Platin Border
Açık Gri / Light Grey

9x60
9x60

Açık Gri / Light Grey
Gri / Grey

Parlak / Glossy
Parlak / Glossy

K94434800001VTE0
K94434900001VTE0



Soft Kahve / Soft Brown

60x60
60x60
60x60
60x60

Soft Kahve / Soft Brown
Açık Bej / Light Beige
Açık Gri / Light Grey
Gri / Grey

LPR
LPR
LPR
LPR

K928105LPR01VTE0
K928094LPR01VTE0
K928061LPR01VTE0
K928072LPR01VTE0

60x60
60x60
60x60
60x60

Soft Kahve / Soft Brown
Açık Bej / Light Beige
Açık Gri / Light Grey
Gri / Grey

FCPR
FCPR
FCPR
FCPR

K945034R0001VTE0
K945033R0001VTE0
K945031R0001VTE0
K945032R0001VTE0

45x45
45x45
45x45
45x45

Açık Bej / Light Beige
Açık Gri / Light Grey
Gri / Grey
Kahve / Brown

Mat / Matt
Mat / Matt
Mat / Matt
Mat / Matt

K94106600001VTE0
K94107000001VTE0
K94108100001VTE0
K94109200001VTE0



Yer Karoları / Floor Tiles : K94460700001VTE0 33x33 Ethereal XS Kum Gri / Sand Grey

Duvar Karoları / Wall Tiles : K94461600001VTE0 20x25 Ethereal XS Açık Gri/ Light Grey
K94461800001VTE0 Ethereal XS Kum Gri/ Sand Grey

ETHEREAL XS



PRO

NATURE

ETHEREAL XS

Doğal mermerin kendi içindeki çeşitliliğinden ilham alan ethereal, modern geometrik düzenle duvarlara yansıyor. Beş farklı görsellikte tasarlanan seride, bir karo içindeki farklı renk ve desenler aracılığıyla, doğal mermerdeki el işçiliği en ihtişamlı haliyle mekânlara değer katıyor.

Inspired by the intrinsic variety of natural marble, ethereal embellishes walls with modern geometrical shapes. The series is characterized with a magnificent workmanship on natural marble stone displayed by means of different colors and patterns forming five visual alternatives.

Duvar Karoları / Wall Tiles

Yüzey Alternatifleri / Surface Alternatives
Parlak / Glossy

Fon Ebatları / Basic Tile Sizes
20x25 cm

Fon Renkleri / Basic Tile Colors
Açık Gri / Light Grey
Kum Gri / Sand Grey

Kullanım Alanları / Usage Areas
Konut / Residential

Döşeme Alanları / Tiling Areas
Duvar / Wall

Dona Dayanım / Frost Resistance
Yok / Not Available

Baskı Teknolojisi / Printing Technology
RealLook

Desen Farklılaşması / Shade Variation Classification
V3

Ürün Standardı / Product Standard
EN14411 Group BIII

Dip Notlar / Footnotes
B H



Duvar Karosu
Wall Tile



Konut
Residential



Desen Farklılaşması
Shade Variation



Rektifiyesiz
Non-Rectified



Parlak
Glossy



Decor
Printing

Seramik Yer Karosu/ Porcelain and Tiles

Bünye / Body Type

Seramik Yer Karoları / Ceramic Floor Tiles

Yüzey Alternatifleri / Surface Alternatives

Mat / Matt

Fon Ebatları / Basic Tile Sizes

33x33 cm

Fon Renkleri / Basic Tile Colors

Açık Gri / Light Grey

Kum Gri / Sand Grey

Kullanım Alanları / Usage Areas

Konut / Residential

Döşeme Alanları / Tiling Areas

Duvar / Wall

Yer / Floor

Dona Dayanım / Frost Resistance

Var / Available

Desen Farklılaşması / Shade Variation Classification

V3

Baskı Teknolojisi / Printing Technology

RealLook

Ürün Standardı / Product Standard

EN14411 Group B1b

Dip Notlar / Footnotes

H P R



Porselen
Porcelain



Yer Karosu
Floor Tile



Duvar Karosu
Wall Tile



Konut
Residential



Dona Dayanım
Frost Resistance



Desen Farklılaşması
Shade Variation



Rektifiyesiz
Non Rectified



Lappato



Mat
Matt

ETHEREAL XS

Duvar Karoları / Wall Tiles



20x25

Parlak / Glossy

K94461600001VTE0

Açık Gri / Light Grey



20x25

Parlak / Glossy

K94461800001VTE0

Kum Gri / Sand Grey

Seramik Karolar / Ceramic Tiles



Açık Gri / Light Grey
Kum Gri / Sand Grey

33x33
33x33

K94460200001VTE0
K94460700001VTE0

Kum Gri / Sand Grey



Duvar Karolari / Wall Tiles : K92132600001VTE0 30x60 Blast Beyaz / White
K92030200001VTE0 30x60 Blast Gri / Grey
K08001500001VTE0 30x60 Blast Gri Dekor / Grey Decor

BLAST



PRO

NATURE

BLAST

Yeni nesil mermer dokusunun damarlarında çarpıcı renk karışımları barındıran seramik serisi. Doğal görünümü ve üç boyutlu dekorlarıyla kullanıldığı mekanları sadelikle zenginleştiren modern tasarım seçenekleri sunuyor. Mermer dokulu yüzeyleri, organik akışkan desenlere sahip üç boyutlu dekorları ve uyumlu yer karolarıyla modern mekânlar tasarlamak için ideal.

A ceramic series having striking color blends in the veins of a new generation marble texture. It offers modern design options that enrich the spaces used, with its natural look and three-dimensional decors. Ideal for designing modern spaces with marble textured surfaces, three-dimensional decors with organic fluid patterns and harmonious floor tiles.

Duvar Karoları / Wall Tiles

**Fon ve Dekor Ebatları /
Basic Tile and Decor Sizes**
30x60 cm (298x598 mm)

Yüzey Alternatifleri / Surface Alternatives
Mat / Matt

**Fon ve Dekor Renkleri /
Basic Tile and Decor Colors**
Beyaz / White
Gri / Grey

Kullanım Alanları / Usage Areas
Konut / Residential

Döşeme Alanları / Tiling Areas
Duvar / Wall

Dona Dayanım / Frost Resistance
Yok / Not Available

**Desen Farklılaşması / Shade Variation
Classification**
V2

Baskı Teknolojisi / Printing Technology
ReaLook

Ürün Standardı / Product Standard
EN14411 Group BIII

Dip Notlar / Footnotes



Duvar Karosu
Wall Tile



Konut
Residential



Mat
Matt



Rektifiyesiz
Non Rectified



Desen Farklılaşması
Shade Variation

Porselen Karolar / Porcelain Tiles

Bünye / Body Type

Sırlı Porselen / Glazed Porcelain

Yüzey Alternatifleri / Surface Alternatives

Mat / Matt

Fon Ebatları / Basic Tile Sizes

45x45 cm (447x447 mm)

Fon ve Dekor Renkleri / Basic Tile and Decor Colors

Beyaz / White

Gri / Grey

Kullanım Alanları / Usage Areas

Konut / Residential

Döşeme Alanları / Tiling Areas

Yer / Floor

Duvar / Wall

Dona Dayanım / Frost Resistance

Var / Available

Desen Farklılaşması / Shade Variation Classification

V2

Baskı Teknolojisi / Printing Technology

ReaLook

Ürün Standardı / Product Standard

EN14411 Group B1a

Dip Notlar / Footnotes

H



Porselen
Porcelain



Yer Karosu
Floor Tile



Duvar Karosu
Wall Tile



Konut
Residential



Dona Dayanım
Frost Resistance



Desen Farklılaşması
Shade Variation



Mat
Matt



Rektifiyesiz
Non Rectified



Rektifiyeli
Rectified

BLAST

Duvar Karoları / Wall Tiles



30x60

Mat / Matt

K92132600001VTE0

Beyaz / White



30x60

Mat / Matt

K08064500001VTE0

Dekor / Decor
Beyaz / White



30x60

Mat / Matt

K92030200001VTE0

Gri / Grey



30x60

Mat / Matt

K08001500001VTE0

Dekor / Decor
Gri / Grey

Porselen Karolar / Porcelain Tiles



45x45

Mat / Matt

K93589000001VTE0

Beyaz / White



45x45

Mat / Matt

K935886000001VTE0

Gri / Grey



DECOCREAM



Duvar Karoları / Wall Tiles : K94371800001VTE0 30x60 Decocream Sıcak Gri / Warm Grey
K94373600001VTE0 30x60 Decocream Büyük Shelter 3D Dekor / Large Shelter 3D Decor S. Gri / W. Grey



PRO

NATURE

DECOCREAM

İspanyol Crema Marfil mermerinin modern bir yorumu olan seramik serisi. Seri, 3D rölyefli yapısı sayesinde klasik bir sunum yaratmaktan çıkıp mekânlara modern bir kimlik katıyor. Rahatlatıcı ve sakin renklerin hâkim olduğu bu şık duvar karosu serisinde, orijinal krem renginin yanında sıcak bir gri tonu da bulunuyor. 30X60 cm ebadında sunulan Decocream, göz alıcı tasarımıyla farklı kullanım alanları için estetiği ve doğallığıyla güçlü bir seçenek oluşturuyor.

A ceramic series wrapping up spanish Crema Marfil marble with a modern and warm look. Thanks to 3D modern relief, the series goes beyond classic presentation and adds modern identity to spaces. Comforting and calm tones dominate the series; apart from the original cream, a warm grey option is available. Decocream provided in 30x60 cm with various decor alternatives creates a strong option for different usage areas with its aesthetic and natural look.

Duvar Karoları / Wall Tiles

Yüzey Alternatifleri / Surface Alternatives
Parlak / Glossy

Fon Ebatları / Basic Tile Sizes
30x60 cm (298x598 mm)

Dekor Ebatları / Decor Sizes
30x60 cm (298x598 mm)
8x60 cm (Bordür / Border)

Fon ve Dekor Renkleri / Basic Tile and Decor Colors
Krem / Cream
Sıcak Gri / Warm Grey

Uyumlu Yer Karoları / Compatible Floor Tiles
Marfim

Kullanım Alanları / Usage Areas
Konut / Residential

Döşeme Alanları / Tiling Areas
Duvar / Wall

Dona Dayanım / Frost Resistance
Yok / Not Available

Desen Farklılaşması / Shade Variation Classification
V3

Baskı Teknolojisi / Printing Technology
ReaLook
Reaktif Ink / Reactive Ink

Ürün Standardı / Product Standard
EN14411 Group BIII

Dip Notlar / Footnotes

H A



Duvar Karosu
Wall Tile



Konut
Residential



Desen Farklılaşması
Shade Variation



Rektifiyesiz
Non Rectified



Reaktif Ink
Reactive Ink



Parlak
Glossy

DECOCREAM

Duvar Karoları / Wall Tiles



30x60 Parlak / Glossy K94371700001VTE0

Krem / Cream



30x60 Parlak / Glossy K94372700001VTE0

Büyük Shelter 3D Dekor / Large Shelter 3D Dekor
Krem / Cream



30x60 Parlak / Glossy K94699900001VTE0

Dalga Dekor / Wave Dekor
Krem / Cream



30x60 Parlak / Glossy K94371800001VTE0

Sıcak Gri / Warm Grey



30x60 Parlak / Glossy K94373600001VTE0

Büyük Shelter 3D Dekor / Large Shelter 3D Dekor
Sıcak Gri / Warm Grey



30x60 Parlak / Glossy K94699800001VTE0

Dalga Dekor / Wave Dekor
Sıcak Gri / Warm Grey



VERSUS - S



Yer Karoları / Floor Tiles : K94539700001VTE0 45X45 Versus - S Krem / Cream

Duvar Karoları / Wall Tiles : K94517100001VTE0 25x40 Versus - S Krem / Cream

K94517300001VTE0 25x40 Versus - S Krem G. Dalga Dekor / L. Wave Decor Cream

PRO

NATURE

VERSUS S

Silver Fantasy mermerini, doğasına en yakın tonlarıyla mekânlara yansıtan yeni seramik serisi. Duvar karolarının yanı sıra, aynı tasarım dilinde porselenlere de sahip seri, zıtlıklardan besleniyor ve döşendiği her ortamda minimal ve modern bir atmosfer yaratıyor.

A new ceramic series using Silver Fantasy marble with Hues which are closest to its natural color presented with porcelain tiles in addition to its wall tiles, Versus is enriched with contrasts creating a sense of minimalism and modernity in all spaces.

Duvar Karoları / Wall Tiles

Fon ve Dekor Ebatları / Basic Tile and Decor Sizes

25x40 cm
7,5x25 cm

Yüzey Alternatifleri / Surface Alternatives

Parlak / Glossy

Fon ve Dekor Renkleri / Basic Tile and Decor Colors

Krem / Cream
Sıcak Gri / Warm Grey

Kullanım Alanları / Usage Areas

Konut / Residential

Döşeme Alanları / Tiling Areas

Duvar / Wall

Dona Dayanım / Frost Resistance

Yok / Not Available

Desen Farklılaşması / Shade Variation Classification

V3

Baskı Teknolojisi / Printing Technology

ReaLook

Ürün Standardı / Product Standard

EN14411 Group BIII



Duvar Karosu
Wall Tile



Konut
Residential



Parlak
Glossy



Rektifiyesiz
Non Rectified



V3
Desen Farklılaşması
Shade Variation

Yer Karoları / Floor Tiles

Bünye / Body Type

Sırlı Porselen / Glazed Porcelain

Yüzey Alternatifleri / Surface Alternatives

Mat / Matt

Fon Ebatları / Basic Tile Sizes

45x45 cm (447x447 mm)

Fon Renkleri / Basic Tile Colors

Krem / Cream

Sıcak Gri / Warm Grey

Kullanım Alanları / Usage Areas

Konut / Residential

Döşeme Alanları / Tiling Areas

Yer / Floor

Dona Dayanım / Frost Resistance

Var / Available

Desen Farklılaşması /

Shade Variation Classification

V3

Baskı Teknolojisi / Printing Technology

ReaLook

Ürün Standardı / Product Standard

EN14411 Group Bla (Glazed Porcelain)



Porselen
Porcelain



Yer Karosu
Floor Tile



Konut
Residential



Dona Dayanım
Frost Resistance



V3
Desen Farklılaşması
Shade Variation



Mat
Matt



Rektifiyesiz
Non Rectified

VERSUS - S

Duvar Karoları / Wall Tiles



25x40 Parlak / Glossy K94517100001VTE0

Krem / Cream



25x40 Parlak / Glossy K94517200001VTE0

Sıcak Gri / Warm Grey



25x40 Parlak / Glossy K94517300001VTE0

Krem / Cream
G. Dalga Dekor / L. Wave Decor



25x40 Parlak / Glossy K94539200001VTE0

Sıcak Gri / Warm Grey
G. Dalga Dekor / L. Wave Decor



7,5x25 Parlak / Glossy K94539300001VTE0

Krem / Cream Bullnose



7,5x25 Parlak / Glossy K94539400001VTE0

Sıcak Gri / Warm Grey Bullnose

Porselen Karolar / Porcelain Tiles



45x45 Mat / Matt K94539700001VTE0

Krem / Cream



45x45 Mat / Matt K94539800001VTE0

Sıcak Gri / Warm Grey



Yer Karoları / Floor Tiles : K94500700001VTE0 M45x45 Inside - S Gri / Grey

Duvar Karoları / Wall Tiles : K94495000001VTE0 25x40 Inside - S Kum Beji / Sand

K94494900001VTE0 25x40 Inside - S Kum Beji G. Dalga Dekor / Sand L. Wave Decor

INSIDE - S



Duvar Karoları / Wall Tiles

Fon ve Dekor Ebatları / Basic Tile and Decor Sizes

25x40 cm
7,5x25 cm

Yüzey Alternatifleri / Surface Alternatives

Parlak / Glossy

Fon ve Dekor Renkleri / Basic Tile and Decor Colors

Kum Beji / Sand
Gri / Grey

Kullanım Alanları / Usage Areas

Konut / Residential

Döşeme Alanları / Tiling Areas

Duvar / Wall

Dona Dayanım / Frost Resistance

Yok / Not Available

Desen Farklılaşması / Shade Variation Classification

V3

Baskı Teknolojisi / Printing Technology

ReaLook

Ürün Standardı / Product Standard

EN14411 Group BIII

PRO

NATURE

INSIDE - S

Dünyaca ünlü İspanyol mermeri Emprador'un dokusu ile tasarlanan seramik serisi, yoğun damarlı yapısı ve doğal renkleriyle mekanlarda ihtişamlı bir atmosfer yaratıyor. Seriyi tamamlayan panel dekoru, mermerin asaletini, eski çağlardan kalma ihtişamlı görünümde dev floral deseniyle duvarlara taşıyor.

A ceramic series reflecting the texture of world famous Spanish marble Emprador with inspiration from Madrid, inside creates a magnificent atmosphere with its intense venous structure and natural colors. The panel decor complementing the series brings the noble character of marble to walls with gigantic floral pattern reminding one of the ancient times.



Duvar Karosu
Wall Tile



Konut
Residential



Desen Farklılaşması
Shade Variation



Parlak
Glossy



Rektifiyesiz
Non Rectified

Porselen Karolar / Porcelain Tiles

Bünye / Body Type

Sırlı Porselen / Glazed Porcelain

Yüzey Alternatifleri / Surface Alternatives

Mat / Matt

Fon Ebatları / Basic Tile Sizes

45x45 cm (447x447 mm)

Fon Renkleri / Basic Tile Colors

Kum Beji / Sand

Gri / Grey

Kullanım Alanları / Usage Areas

Konut / Residential

Döşeme Alanları / Tiling Areas

Yer / Floor

Dona Dayanım / Frost Resistance

Var / Available

Desen Farklılaşması /

Shade Variation Classification

V3

Baskı Teknolojisi / Printing Technology

ReaLook

Ürün Standardı / Product Standard

EN14411 Group B1a



Porselen
Porcelain



Yer Karosu
Floor Tile



Konut
Residential



Dona Dayanım
Frost Resistance



V3
Desen Farklılaşması
Shade Variation



Mat
Matt



Rektifiyesiz
Non Rectified

INSIDE - S

Duvar Karoları / Wall Tiles



25x40 Parlak / Glossy K94495000001VTEO

Kum Beji / Sand



25x40 Parlak / Glossy K94494800001VTEO

Gri / Grey



25x40 Parlak / Glossy K94494900001VTEO

Kum Beji / Sand
Dalga G. Dekor / L. Wave Decor



25x40 Parlak / Glossy K94494700001VTEO

Gri / Grey
Dalga G. Dekor / L. Wave Decor

Porselen Karolar / Porcelain Floor Tiles



45x45 Mat / Matt K94500800001VTE0

Kum Beji / Sand



45x45 Mat / Matt K94500700001VTE0

Gri / Grey



Yer Karoları / Floor Tiles : K94540600001VTE0 33x33 Celebration - S Vizon / Mink

Duvar Karoları / Wall Tiles : K94540000001VTE0 25x40 Celebration - S Vizon / Mink
K94660800001VTE0 25x40 Celebration - S Krem Dalga Dekor / Wave Decor Cream

CELEBRATION - S



PRO

NATURE

CELEBRATION - S

Tutkulu mekânlar yaratmak için gereken tüm detayları deseninde taşıyan Celebration serisinin mermer görünümlü parlak yüzeyi mekânlara canlılık getiriyor. Krem, vizon ve antrasit renkleriyle mekânlara derinlik katan porselen karolar üç boyutlu rölyefli dekorlarıyla duvarlarda hareketlilik sağlıyor.

A ceramic series with glossy surface embodying all the details required for creating spaces full of passion. Celebration adds liveliness to spaces with its marble-like polished surface while fostering the dynamism of walls with three dimensional relief decors.

Duvar Karoları / Wall Tiles

Fon ve Dekor Ebatları / Basic Tile and Decor Sizes

25x40 cm (248x398 mm)
7,5x25 cm

Yüzey Alternatifleri / Surface Alternatives

Parlak / Glossy

Fon ve Dekor Renkleri / Basic Tile and Decor Colors

Krem / Cream
Vizon / Mink

Kullanım Alanları / Usage Areas

Konut / Residential

Döşeme Alanları / Tiling Areas

Duvar / Wall

Dona Dayanım / Frost Resistance

Yok / Not Available

Baskı Teknolojisi / Printing Technology

ReaLook

Ürün Standardı / Product Standard

EN14411 Group BIII



Duvar Karosu
Wall Tile



Konut
Residential



Parlak
Glossy



Rektifiyesiz
Non Rectified

PRO

NATURE

CELEBRATION - S

Porselen Karolar / Porcelain Tiles

Bünye / Body Type

Sırlı Porselen / Glazed Porcelain

Yüzey Alternatifleri / Surface Alternatives

Mat / Matt

Fon Ebatları / Basic Tile Sizes

45x45 cm (447x447 mm)

Fon Renkleri / Basic Tile Colors

Krem / Cream

Vizon / Mink

Kullanım Alanları / Usage Areas

Konut / Residential

Döşeme Alanları / Tiling Areas

Yer / Floor

Dona Dayanım / Frost Resistance

Var / Available

Desen Farklılaşması / Shade Variation Classification

V3

Baskı Teknolojisi / Printing Technology

ReaLook

Ürün Standardı / Product Standard

EN14411 Group Bla



Porselen
Porcelain



Yer Karosu
Floor Tile



Konut
Residential



Dona Dayanım
Frost Resistance



V3
Desen Farklılaşması
Shade Variation



Mat
Matt



Rektifiyesiz
Non Rectified

CELEBRATION - S

Duvar Karoları / Wall Tiles



25x40 Parlak / Glossy K94539900001VTE0

Krem / Cream



25x40 Parlak / Glossy K94540000001VTE0

Vizon / Mink



25x40 Parlak / Glossy K94660800001VTE0

Krem / Cream
Dalga Dekor / Wave Decor



25x40 Parlak / Glossy K94660900001VTE0

Vizon / Mink
Dalga Dekor / Wave Decor



7,5x25 Parlak / Glossy K94540300001VTE0

Krem Bull / Cream Bull



7,5x25 Parlak / Glossy K94540400001VTE0

Vizon Bull / Mink Bull

Porselen Karolar / Porcelain Tiles



45x45 Mat / Matt K94540700001VTE0

Krem / Cream



45x45 Mat / Matt K94540900001VTE0

Vizon / Mink



CERAMIC CULTURE

SERAMİK KÜLTÜRÜ

Seramik, insanlığın en eski bilgeliđi. Dokuları, renkleri ve yapılara karakter kazandıran tasarım zenginliđi ile binlerce yıllık seramik kùltürü yaratıcılıđınıza yeni kapılar açıyor.

Ceramics is the oldest wisdom of humankind. Thousands of years-old ceramic culture opens new doors to your creativity with its textures, colors and diversity while designing the buildings.



Yeni
Novelty

PRO

NATURE

SCALE

Büyük boyutun mimari değerini ortaya çıkaran porselen koleksiyonu. Scale koleksiyonu, bütünsel bir monokrom görüntü ve ColorCode yaklaşımının tüm sıcak ve soğuk renkleriyle uyum sağlıyor. Esnek ve dayanıklı yapısıyla Scale, mimarlar için iç ve dış mekân uygulamalarında geniş çözümler sunuyor.

A porcelain collection that brings to the fore the architectural value of large size. The Scale collection creates a monochrome look that is compatible with the full range of warm and cold colors in the ColorCode approach. Thanks to its flexibility and durability, Scale offers architects a wide range of solutions for interiors and exteriors.

Duvar Karoları / Wall Tiles

Bünye / Body Type

Slab

Yüzey Alternatifleri / Surface Alternatives

Mat / Matt

Desen Farklılaşması /

Shade Variation Classification

V1

Fon ve Dekor Renkleri / Basic Tile and Decor Colors

100x300 cm (R 97x300mm)

100x100 cm (R 97x97mm)

Baskı Teknolojisi / Printing Technology

Digital Print Technology

Ürün Standardı / Product Standard

EN14411 Group BIII

Dip Notlar / Footnotes



Yeni
Novelty



Dona Dayanım
Frost Resistance



Ticari Alan
Commercial



Mat
Matt



Rektifiyeli
Rectified



Modülerlik
Modularity



Dış Cephe
Facade



Dış Mekanlar
Outdoors



Desen Farklılaşması
Shade Variation

SCALE

Duvar Karoları / Wall Tiles



Koyu Grej / Dark Greige

100x300 REC 5,5mm

100x300 REC 3,5mm

100x100 REC 5,5mm

K947480R0001VTS0

K947476R0001VTS0

K947810R0001VTS0



Vizon / Mink

100x300 REC 5,5mm

100x300 REC 3,5mm

100x100 REC 5,5mm

K947482R0001VTS0

K947478R0001VTS0

K947813R0001VTS0



Yeni
Novelty



Koyu Gri / Dark Grey

100x300 REC 5,5mm

100x300 REC 3,5mm

100x100 REC 5,5mm

K947481R0001VTS0

K947477R0001VTS0

K947811R0001VTS0



Gri / Grey

100x300 REC 5,5mm

100x300 REC 3,5mm

100x100 REC 5,5mm

K947479R0001VTS0

K947475R0001VTS0

K947812R0001VTS0



HOMEMADE X



Yer Karoları / Floor Tiles : K945785LPR01VTE0 60x60 Newcon Gümüş Gri / Silver Grey

Duvar Karoları / Wall Tiles : K94630600001VTE0 10x30 Homemade X Safir Mavi Ç. Dekor / Sapphire Blue Frame Decor
K945000R0001VTE0 33x100 Metamarmo Mavi / Blue



PRO

NATURE

HOMEMADE X

Yirminci yüzyılın minimal tasarım çizgilerini günümüzün renkleri ile birleştiren seramik serisi, iç mekânlarda retro bir atmosfer yaratıyor. Moda ve dekorasyon dünyasının iki asil rengi; zümrüt yeşili ve safir mavisi tonlarında tasarlanan seride, yalın sadeliğiyle beyaz ve metalik parlaklığıyla bronz renk seçenekleri de bulunuyor.

Ceramic collection, which combines the minimal design lines of the twentieth century with trending colours of today, creates a retro atmosphere at the interior spaces. The collection, which is designed in the shades of fashionable emerald green and sapphire blue, has the white colour options in plain simplicity as well as the bronze colour options in metallic luminosity.

Duvar Karoları / Wall Tiles

Yüzey Alternatifleri / Surface Alternatives
Parlak / Glossy

Fon Ebatları / Basic Tile Sizes
10x30 cm (97x297 mm)

Dekor Ebatları / Decor Sizes
10x30 cm (97x297 mm)

Fon ve Dekor Renkleri / Basic Tile and Decor Colors
Beyaz / White
Safir Mavi / Sapphire Blue
Zümrüt Yeşil / Emerald Green
Bronz / Bronze

Uyumlu Yer Karoları / Compatible Floor Tiles

Calacatta
Metamarmo
Newcon

Kullanım Alanları / Usage Areas
Konut / Residential

Döşeme Alanları / Tiling Areas
Duvar / Wall

Dona Dayanım / Frost Resistance
Yok / Not Available

Baskı Teknolojisi / Printing Technology
ReaLook

Ürün Standardı / Product Standard
EN14411 Group BIII

Dip Notlar / Footnotes



Yeni
Novelty



Duvar Karosu
Wall Tile



Konut
Residential



Parlak
Glossy



Rektifiyesiz
Non-Rectified



Ödüllü
Award Winning



GOOD
DESIGN
AWARD
2018

HOMEMADE X

Duvar Karoları / Wall Tiles



10x30 Parlak / Glossy K94630500001VTE0

Beyaz / White



10x30 Parlak / Glossy K94630300001VTE0

Safir Mavi / Sapphire Blue



10x30 Parlak / Glossy K94630400001VTE0

Zümrüt Yeşil / Emerald Green

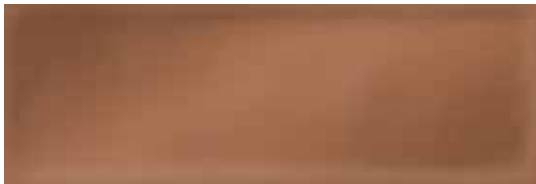

10x30 Mat / Matt K94664600001VTE0

Bronze / Bronze

Bakır Çubuk Bordür - Logolu / Copper Line Border - Logo 1x100 K356997LZ001VTE0
3x100 K085976LZ001VTE0

Bakır Çubuk Bordür / Copper Line Border 1x100 K35699700001VTE0
3x100 K08597600001VTE0



10x30 Parlak / Glossy K94630800001VTE0

Çerçeve Dekor / Frame Decor
Beyaz / White



10x30 Parlak / Glossy K94630600001VTE0

Çerçeve Dekor / Frame Decor
Safir Mavi / Sapphire Blue



10x30 Parlak / Glossy K94630700001VTE0

Çerçeve Dekor / Frame Decor
Zümrüt Yeşil / Emerald Green



Yer Karoları / Floor Tiles : K945720R0001VTE0 60x60 Clay-Cement Toprak / Dark Clay

Duvar Karoları / Wall Tiles : K946247R0001VTS0 33x100 Pearlart İnci / Pearl
K946268R0001VTS0 33x100 Pearlart İnci Altıgen Dekor / Pearl Hexagon Dekor
K946248R0001VTS0 33x100 Pearlart Bronz / Bronze
K946643R0001VTS0 33x100 Pearlart Bronz Altıgen Dekor / Bronze Hexagon Dekor

PEARLART





**BJÖRK
&
BERRIED**
Scented
Candles
**WHITE FOREST
SIZED CANDLES**
100% SOY
WAX



PRO

NATURE

PEARLART

Kullanıldığı mekânlara mücevher ışıltısı ve şıklığı getiren seramik serisi. Metalik bronz ve inci beyazı renklerin, üç boyutlu altıgen rölyefler ve üzerindeki mikro dokularla yaptığı yansımalar duvarlara yeni bir boyut kazandırıyor. İncinin huzurunu bronzun çarpıcı etkisiyle dengeleyen banyolar, kusursuz bir mücevher ile çevrili olma hissi yaratıyor.

Ceramic collection which brings jewel glimmer and elegance to the spaces it is used. Metallic bronze and pearl white reflections with 3D hexagonal reliefs and micro textures transform the walls to a new dimension. The bathrooms, which balance the peace of pearl with the striking effect of bronze, create a sense of being surrounded by a flawless jewel.

Duvar Karoları / Wall Tiles

Yüzey Alternatifleri / Surface Alternatives
Mat / Matt

Fon Ebatları / Basic Tile Sizes
33x100 cm (R 329x991 mm)

Dekor Ebatları / Decor Sizes
33x100 cm (R 329x991 mm)

Fon ve Dekor Renkleri / Basic Tile and Decor Colors
İnci / Pearl
Bronz / Bronze

Uyumlu Yer Karoları / Compatible Floor Tiles

Clay-Cement
Studio-Mix
Metalcrete
Urbancrete
Urbanwood
Stonelevel

Kullanım Alanları / Usage Areas
Konut / Residential

Döşeme Alanları / Tiling Areas
Duvar / Wall

Dona Dayanım / Frost Resistance
Yok / Not Available

Baskı Teknolojisi / Printing Technology
ReaLook

Ürün Standardı / Product Standard
EN14411 Group BIII

Dip Notlar / Footnotes
H B R M



Yeni
Novelty



Duvar Karosu
Wall Tile



Konut
Residential



Mat
Matt



Rektifiyeli
Rectified



Ödüllü
Award Winning



PEARLART

Duvar Karoları / Wall Tiles



33x100 Mat / Matt K946247R0001VTSo

İnci / Pearl



33x100 Mat / Matt K946248R0001VTSo

Bronz / Bronze



33x100 Mat / Matt K946268R0001VTSo

Altıgen Dekor / Hexagon Decor
İnci / Pearl



33x100 Mat / Matt K946643R0001VTSo

Altıgen Dekor / Hexagon Decor
Bronz / Bronze

Bakır Çubuk Bordür - Logolu / Copper Line Border - Logo

1x100 K356997LZ001VTEo
3x100 K085976LZ001VTEo

Bakır Çubuk Bordür / Copper Line Border

1x100 K35699700001VTEo
3x100 K08597600001VTEo

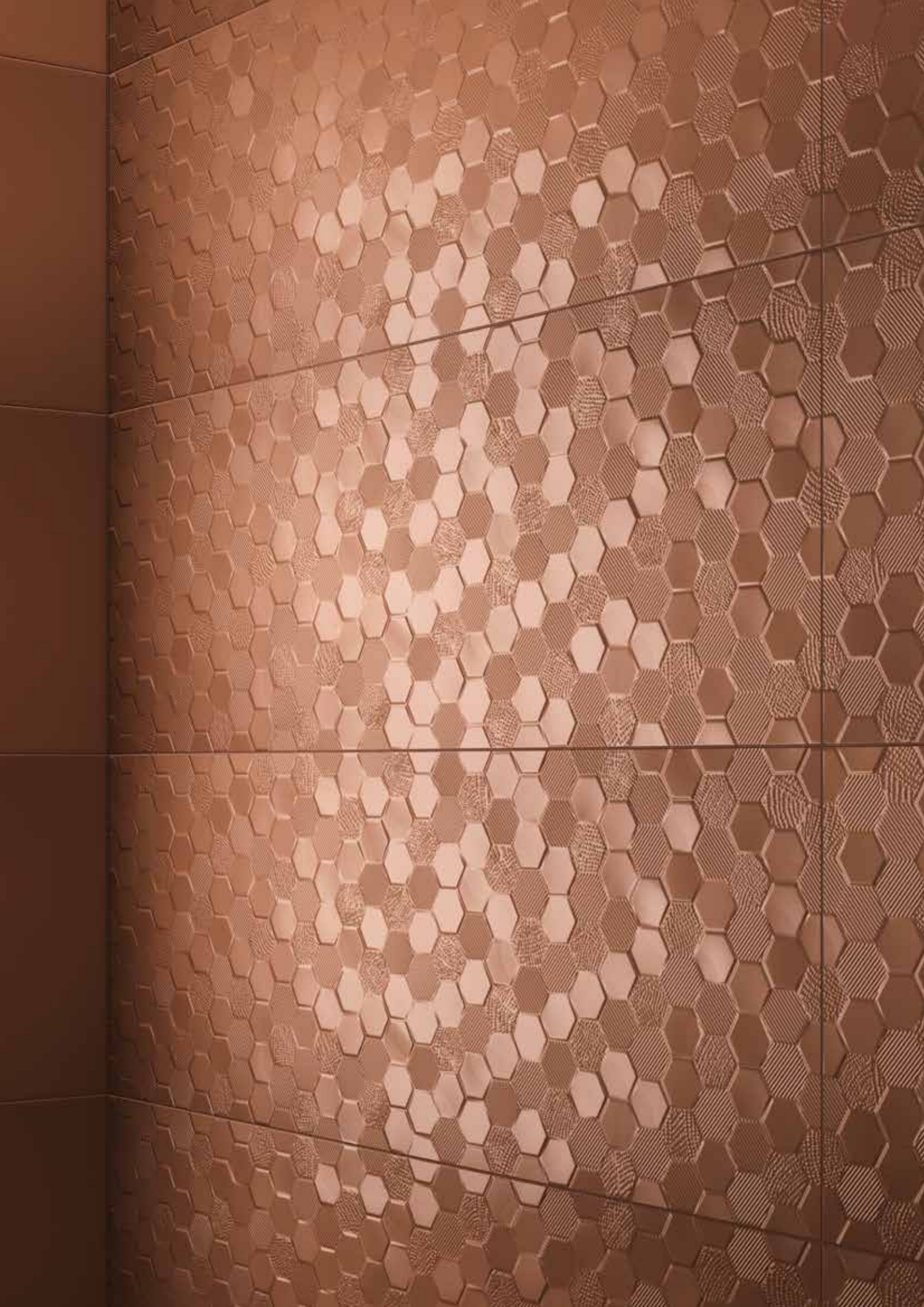



STUDIO - MIX

Yer Karoları / Floor Tiles : K944423R0001VTE0 20x120 Woodmix Krem / Cream

Duvar Karoları / Wall Tiles : K946249R0001VTS0 33x100 Studio-Mix Mermer Pembe / Marble Pink
K946641R0001VTS0 33x100 Studio-Mix Nude / Nude

PRO

NATURE

STUDIO - MIX

Farklı malzeme, renk ve desenlerin sade bir denge içinde bir araya geldiği seramik serisi. Moda dünyasının önde gelen rengi nude, aynı tonlarda damarları olan İtalyan Rosa Aurora mermeri ve pudra efektli beton görünümü ile birlikte yeniden yorumlanıyor. Studio-Mix, bu çarpıcı renkleri ve yüzeyleri metalik bronz aksanlarla birleştirerek banyolarda ultra-feminen bir etki yaratıyor. Seriyeye ait tüm elemanlar birbiri ile kullanılarak, sıcak ve soğuk atmosferde tasarımların bir araya geldiği mekânlar oluşturuyor.

Ceramic collection, which brings together different materials, colours and patterns in simplicity and balance. Nude, the leading colour of the fashion world, is reinterpreted with Italian Rosa Aurora marble having grains in the same shades and powder-effect concrete texture. Studio-Mix combines eye-catching colours and surfaces with metallic bronze accents to create an ultra-feminine effect in the bathrooms. All elements of the collection are used with each other in order to form spaces where warm and cold atmospheres come together.

Duvar Karoları / Wall Tiles

Yüzey Alternatifleri / Surface Alternatives

Mat / Matt

Fon Ebatları / Basic Tile Sizes

33x100 cm (R 329x991 mm)

Fon ve Dekor Renkleri / Basic Tile and Decor Colors

Mermer Pembe / Marble Pink

Nude / Nude

Beton Gri / Cement Blush

Kullanım Alanları / Usage Areas

Konut / Residential

Döşeme Alanları / Tiling Areas

Duvar / Wall

Uyumlu Yer Karoları / Compatible Floor Tiles

Studio-Mix

Urbanwood

Metalcrete

Dona Dayanım / Frost Resistance

Yok / Not Available

Baskı Teknolojisi / Printing Technology

ReaLook

Ürün Standardı / Product Standard

EN14411 Group BIII

Dip Notlar / Footnotes

H R



Yeni
Novelty



Duvar Karosu
Wall Tile



Konut
Residential



Mat
Matt



Rektifiyeli
Rectified



Desen Farklılaşması
Shade Variation

Porselen Karolar / Porcelain Tiles

Bünye / Body Type

Sırlı Porselen / Glazed Porcelain

Yüzey Alternatifleri / Surface Alternatives

R9

Fon Ebatları / Basic Tile Sizes

60x60 cm (597x597 mm)

Fon Renkleri /

Basic Tile and Decor Colors

Beton Gri / Cement Blush

Kullanım Alanları / Usage Areas

Konut / Residential

Döşeme Alanları / Tiling Areas

Yer / Floor

Duvar / Wall

Dona Dayanım / Frost Resistance

Var / Available

Desen Farklılaşması /

Shade Variation Classification

V3

Baskı Teknolojisi / Printing Technology

ReaLook

Ürün Standardı / Product Standard

EN14411 Group B1a

Dip Notlar / Footnotes

H R



Yeni
Novelty



Porselen
Porcelain



Yer Karosu
Floor Tile



Duvar Karosu
Wall Tile



Konut
Residential



Dona Dayanım
Frost Resistance



Desen Farklılaşması
Shade Variation



Mat
Matt



Rektifiyeli
Rectified

STUDIO - MIX

Duvar Karoları / Wall Tiles



33x100 Mat/Matt K946249R0001VTSO

Mermer Pembe / Marble Pink

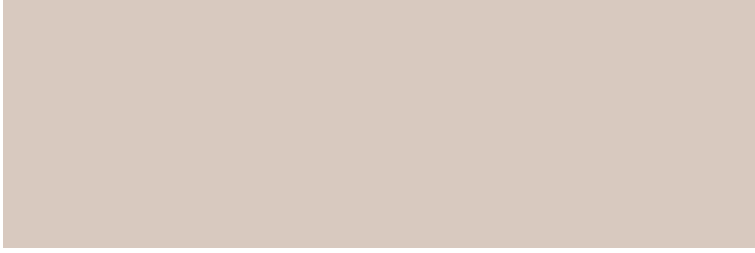

33x100 Mat/Matt K946641R0001VTSO

Nude / Nude



33x100 Mat/Matt K946250R0001VTSO

Beton Gri / Cement Blush



1x100 K356997LZ001VTEO
3x100 K085976LZ001VTEO

Bakır Çubuk Bordür - Logolu / Copper Line Border - Logo



1x100 K35699700001VTEO
3x100 K08597600001VTEO

Bakır Çubuk Bordür / Copper Line Border

Porselen Karolar / Porcelain Tiles



60x60

R9

K946260R0001VTE0

Beton Gri / Cement Blush



STUDIO - TAB



Yer Karoları / Floor Tiles : K946260R0001VTE0 60x60 Studio - Plate Beton Gri / Cement Blush

Duvar Karoları / Wall Tiles : K946667R0001VTS0 33x100 Studio -Tab Beyaz / White
K946255R0001VTS0 33x100 Studio -Tab Dekor / Decor Beyaz / White
K946641R0001VTS0 33x100 Studio -Tab Nude / Nude
K946254R0001VTS0 33x100 Studio -Tab Dekor / Decor Nude / Nude

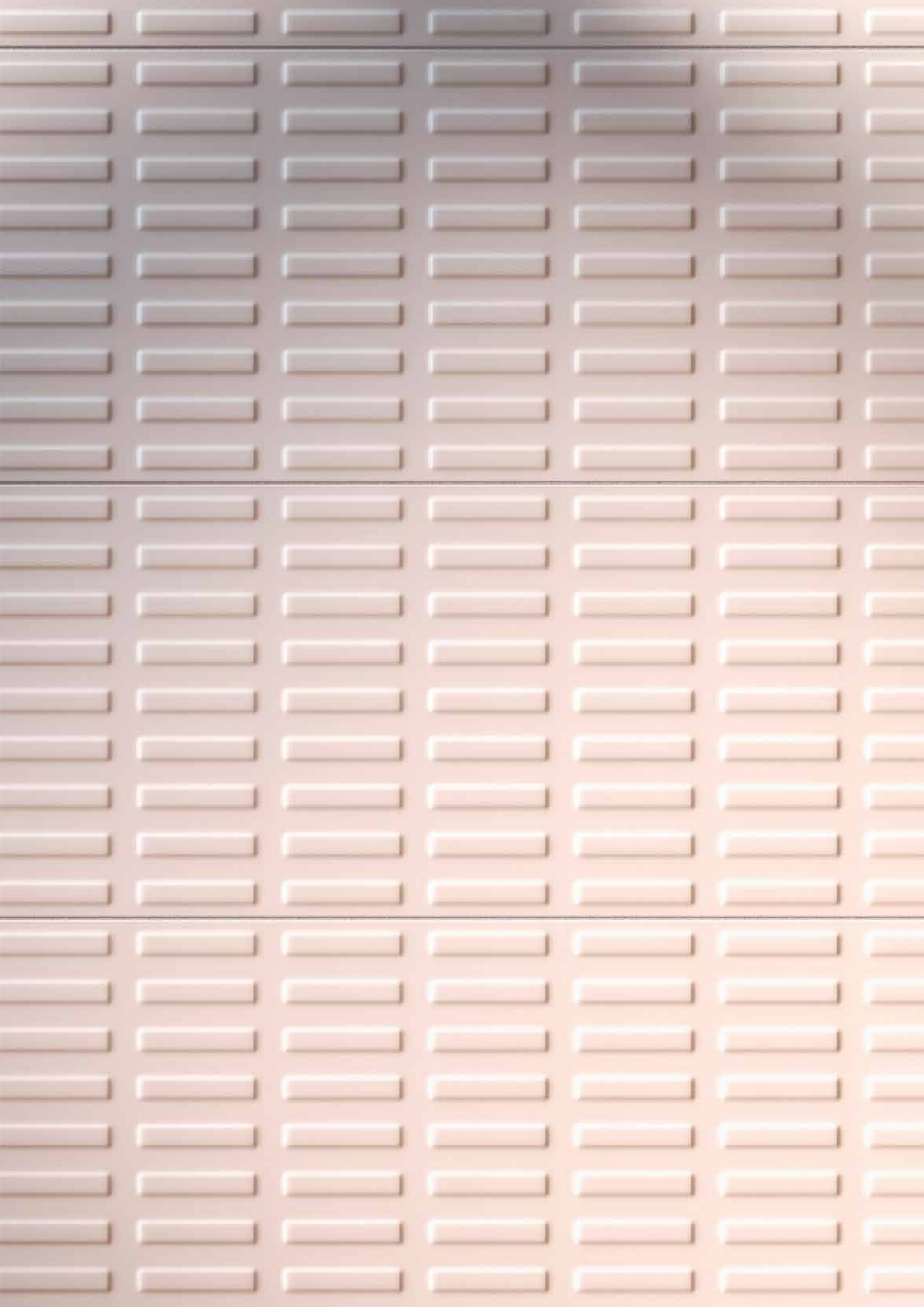

PRO

NATURE

STUDIO - TAB

Endüstriyel duvarların düzenli ve keskin geometrisini, farklı renk ve yuvarlatılmış formlarla yumuşatan sıcak ve yalın tasarımlı seramik serisi. Beyaz ve son yılların moda rengi olan nude tonlarında tasarlanmış olan seri, tüm seçeneklerin birbiri ile kullanılmasına da imkân vererek yenilikçi bir model sunuyor.

Cosy and plain designed ceramic collection, which smooths the regular and sharp geometry of the industrial walls, with diverse colours and rounded forms. Designed in the trendy shades of white and nude, the collection offers an innovative model by allowing all the options to be used in combination with each other.

Duvar Karoları / Wall Tiles

Yüzey Alternatifleri / Surface Alternatives
Mat / Matt

Fon Ebatları / Basic Tile Sizes
33x100 cm (R 329x991 mm)

Dekor Ebatları / Decor Sizes
33x100 cm (R 329x991 mm)

Fon ve Dekor Renkleri / Basic Tile and Decor Colors
Beyaz / White
Nude / Nude

Uyumlu Yer Karoları / Compatible Floor Tiles

Matrix
Woodmix
Studio-Mix
Urbanwood

Kullanım Alanları / Usage Areas
Konut / Residential

Döşeme Alanları / Tiling Areas
Duvar / Wall

Dona Dayanım / Frost Resistance
Yok / Not Available

Baskı Teknolojisi / Printing Technology
ReaLook

Ürün Standardı / Product Standard
EN14411 Group BIII

Dip Notlar / Footnotes



Yeni
Novelty



Duvar Karosu
Wall Tile



Konut
Residential



Mat
Matt



Rektifiyeli
Rectified

STUDIO - TAB

Duvar Karoları / Wall Tiles

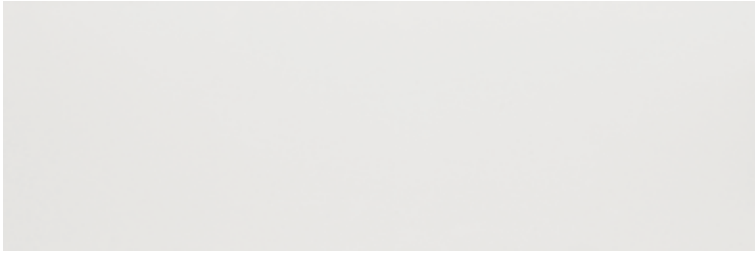

33x100 Mat / Matt K946667R0001VTSO

Beyaz / White



33x100 Mat / Matt K946641R0001VTSO

Nude / Nude



33x100 Mat / Matt K946255R0001VTSO

Studio-Tab Dekor / Studio-Tab Dekor
Beyaz / White



33x100 Mat / Matt K946254R0001VTSO

Studio-Tab Dekor / Studio-Tab Dekor
Nude / Nude





STUDIO - TEX

Yer Karoları / Floor Tiles : K944650R0001VTE0 60x60 Matrix Nude / Nude

Duvar Karoları / Wall Tiles : K946641R0001VTS0 33x100 Studio-TEX Nude / Nude
K946251R0001VTS0 33x100 Studio-TEX Dekor / Dekor Nude / Nude



PRO

NATURE

STUDIO - TEX

Endüstriyel yüzeylerin keskinliğini, tekstil sıcaklığı ile yumuşatan seramik serisi. Tekstil dokuların kusursuz geometrik yapısını, nude ve beyaz gibi hiç eskimeyecek sakın renk tonları ile birleştiren seri, bu sayede tüm ürünlerin birbiri ile kullanımına da imkân sağlıyor.

Ceramic collection which smooths the sharpness of industrial surfaces with the cosiness of textile. Combining the flawless geometric structure of textile textures with tranquil colour shades, such as nude and white, which will never age. The collection allows all the products in the range to be used in combination with each other.

Duvar Karoları / Wall Tiles

Yüzey Alternatifleri / Surface Alternatives
Mat / Matt

Fon Ebatları / Basic Tile Sizes
33x100 cm (R 329x991 mm)

Dekor Ebatları / Decor Sizes
33x100 cm (R 329x991 mm)

**Fon ve Dekor Renkleri /
Basic Tile and Decor Colors**
Beyaz / White
Nude / Nude

Uyumlu Yer Karoları / Compatible Floor Tiles
Matrix
Woodmix
Studio-Mix
Urbanwood

Kullanım Alanları / Usage Areas
Konut / Residential

Döşeme Alanları / Tiling Areas
Duvar / Wall

Dona Dayanım / Frost Resistance
Yok / Not Available

Baskı Teknolojisi / Printing Technology
ReaLook

Ürün Standardı / Product Standard
EN14411 Group BIII

Dip Notlar / Footnotes



Yeni
Novelty



Duvar Karosu
Wall Tile



Konut
Residential



Mat
Matt



Rektifiyeli
Rectified



Desen Farklılaşması
Shade Variation

STUDIO - TEX

Duvar Karoları / Wall Tiles

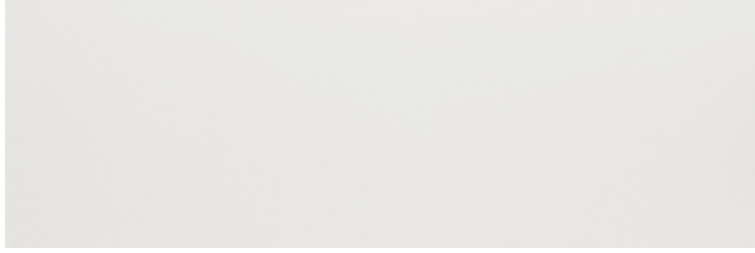

33x100 Mat / Matt K946667R0001VTSO

Beyaz / White

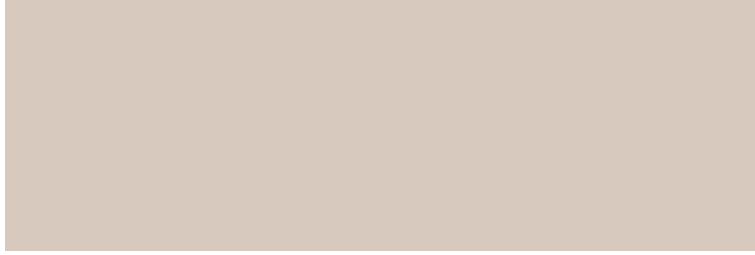

33x100 Mat / Matt K946641R0001VTSO

Nude / Nude



33x100 Mat / Matt K946252R0001VTSO

Studio-TEX Dekor / Studio-TEX Decor
Beyaz / White



33x100 Mat / Matt K946251R0001VTSO

Studio-TEX Dekor / Studio-TEX Decor
Nude / Nude

Bakır Çubuk Bordür - Logolu / Copper Line Border - Logo

1x100 K356997LZ001VTEO
3x100 K085976LZ001VTEO

Bakır Çubuk Bordür / Copper Line Border

1x100 K35699700001VTEO
3x100 K08597600001VTEO





STUDIO - PLATE



Yer Karoları / Floor Tiles : K946260R0001VTE0 60x60 Studio - Plate Beton Gri / Cement Blush

Duvar Karoları / Wall Tiles : K946250R0001VTS0 33x100 Studio - Plate Beton Gri / Cement Blush
K946400R0001VTS0 33x100 Studio - Plate Dekor / Decor Bronz / Bronze

PRO

NATURE

STUDIO - PLATE

Endüstriyel tasarım trendlerinin samimi yorumunu iç mekânlara taşıyan çarpıcı seramik serisi. Serinin soğuk renk ve yüzeyleri, sıcak bronz ve pudra efekti ile yumuşatılarak kullanıldığı mekânlarda yeni atmosferler yaratıyor. Soğuk ve sıcak formlar bir araya gelerek yeni aksanlar ortaya çıkarıyor. Serideki metalik bronz fon ve dekorlar sayesinde, modern şehirli banyolardaki endüstriyel görüntü lüksle buluşuyor.

Outstanding ceramic collection, which carries the ingenious interpretation of industrial design trends to the interior spaces. The cold colours and surfaces of the collection are smoothed with the warm bronze and powder effect in an effort to create a new atmosphere in the spaces it is used. Cold and warm forms come together to create new accents. The industrial look of the modern urban bathrooms meets with luxury, thanks to the metallic bronze tiles and borders in the collection.

Duvar Karoları / Wall Tiles

Yüzey Alternatifleri / Surface Alternatives
Mat / Matt

Fon Ebatları / Basic Tile Sizes
33x100 cm (R 329x991 mm)

Dekor Ebatları / Decor Sizes
33x100 cm (R 329x991 mm)

Fon ve Dekor Renkleri / Basic Tile and Decor Colors
Beton Gri / Cement Blush
Bronz / Bronze

Kullanım Alanları / Usage Areas
Konut / Residential

Döşeme Alanları / Tiling Areas
Duvar / Wall

Dona Dayanım / Frost Resistance
Yok / Not Available

Uyumlu Yer Karoları / Compatible Floor Tiles
Studio-Plate
Urbanwood
Metalcrete

Baskı Teknolojisi / Printing Technology
ReaLook

Ürün Standardı / Product Standard
EN14411 Group BIII

Dip Notlar / Footnotes

H B R M



Yeni
Novelty



Duvar Karosu
Wall Tile



Konut
Residential



Mat
Matt



Rektifiyeli
Rectified



Desen Farklılaşması
Shade Variation



Ödüllü
Award Winning



GOOD
DESIGN
AWARD
2018

Porselen Karolar / Porcelain Tiles

Bünye / Body Type

Sırlı Porselen / Glazed Porcelain

Yüzey Alternatifleri / Surface Alternatives

R9

Fon Ebatları / Basic Tile Sizes

60x60 cm (597x597 mm)

Fon Renkleri /

Basic Tile and Decor Colors

Beton Gri / Cement Blush

Kullanım Alanları / Usage Areas

Konut / Residential

Döşeme Alanları / Tiling Areas

Yer / Floor

Duvar / Wall

Dona Dayanım / Frost Resistance

Var / Available

Desen Farklılaşması /

Shade Variation Classification

V3

Baskı Teknolojisi / Printing Technology

ReaLook

Ürün Standardı / Product Standard

EN14411 Group Bla

Dip Notlar / Footnotes

H R



Yeni
Novelty



Porselen
Porcelain



Yer Karosu
Floor Tile



Duvar Karosu
Wall Tile



Konut
Residential



Dona Dayanım
Frost Resistance



Desen Farklılaşması
Shade Variation



Mat
Matt



Rektifiyeli
Rectified

STUDIO - PLATE

Duvar Karoları / Wall Tiles



33x100 Mat/Matt K946248R0001VTS0

Bronz / Bronze



33x100 Mat/Matt K946250R0001VTS0

Beton Gri / Cement Blush



Bakır Çubuk Bordür - Logolu / Copper Line Border - Logo

1x100 K356997LZ001VTE0
3x100 K085976LZ001VTE0



Bakır Çubuk Bordür / Copper Line Border

1x100 K35699700001VTE0
3x100 K08597600001VTE0



33x100 Mat/Matt K946400R0001VTS0

Studio-Plate Dekor / Studio-Plate Dekor
Bronz / Bronze



33x100 Mat/Matt K946642R0001VTS0

Studio-Plate Dekor / Studio-Plate Dekor
Beton Gri / Cement Blush

Porselen Karolar / Porcelain Tiles



60x60 R9 K946260R0001VTE0

Beton Gri - Cement Blush



FUTURA - XL

Yer Karoları / Floor Tiles : K933005R0001VTE0 15x90 Woodplus Antrasit / Antrachite

Duvar Karoları / Wall Tiles : K937964R0001VTS0 33x100 Futura - XL3D Dalga Dekor / 3D Wave Decor Beyaz / White

PRO

NATURE

FUTURA - XL

Dalgalı deseni ve dinamik çizgileriyle üç boyutlu bir algı yaratan çarpıcı bir seramik serisi. Futura düz beyaz rengiyle, ferah ve aydınlık mekanlar sunarken her zevke hitap edecek çözümler yaratıyor. Mat yüzeyi ve sıra dışı görünümü, duvarlarda sürükleyici bir etki yaratıyor.

An impressive ceramic series creating a three dimensional effect with its wavy pattern and dynamic lines. Futura combines warm and cool colors to create different alternatives. It makes a striking impact on walls with its matt surface and extraordinary outlook.

Duvar Karoları / Wall Tiles

Yüzey Alternatifleri / Surface Alternatives
Mat / Matt

Fon Ebatları / Basic Tile Sizes
33x100 cm (R 329x991 mm)

Dekor Ebatları / Decor Sizes
33x100 cm

Fon Renkleri / Basic Tile Colors
Beyaz / White

Uyumlu Yer Karoları / Compatible Floor Tiles
Ceppostone
Urbancrete
Urbanwood
Newcon
Woodplus

Kullanım Alanları / Usage Areas
Konut / Residential

Döşeme Alanları / Tiling Areas
Duvar / Wall

Dona Dayanım / Frost Resistance
Yok / Not Available

Ürün Standardı / Product Standard
EN14411 Group BIII

Dip Notlar / Footnotes

®

Duvar Karosu
Wall Tile

Konut
Residential

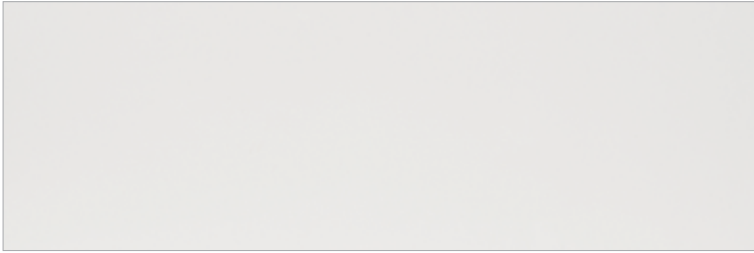

Mat
Matt

Rektifiyeli
Rectified

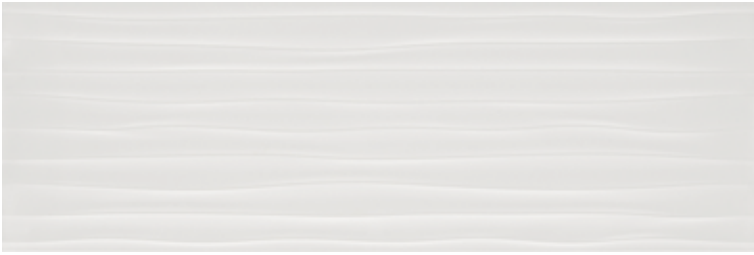

33x100 Mat / Matt K939294R0001VTS0

Beyaz / White



33x100 Mat / Matt K937964R0001VTE0

3D Dalga Dekor / 3D Wave Decor
Beyaz / White



MILLENIUM

Yer Karoları / Floor Tiles :

K906626R0001VTE0 60x60 Ultra Moka / Mocha

Duvar Karoları / Wall Tiles :

K93044100001VTE0 30x60 Millenium A. Vizon /L. Mink

K93045200001VTE0 30x60 Millenium Dekor / Decor A.Vizon / L.Mink

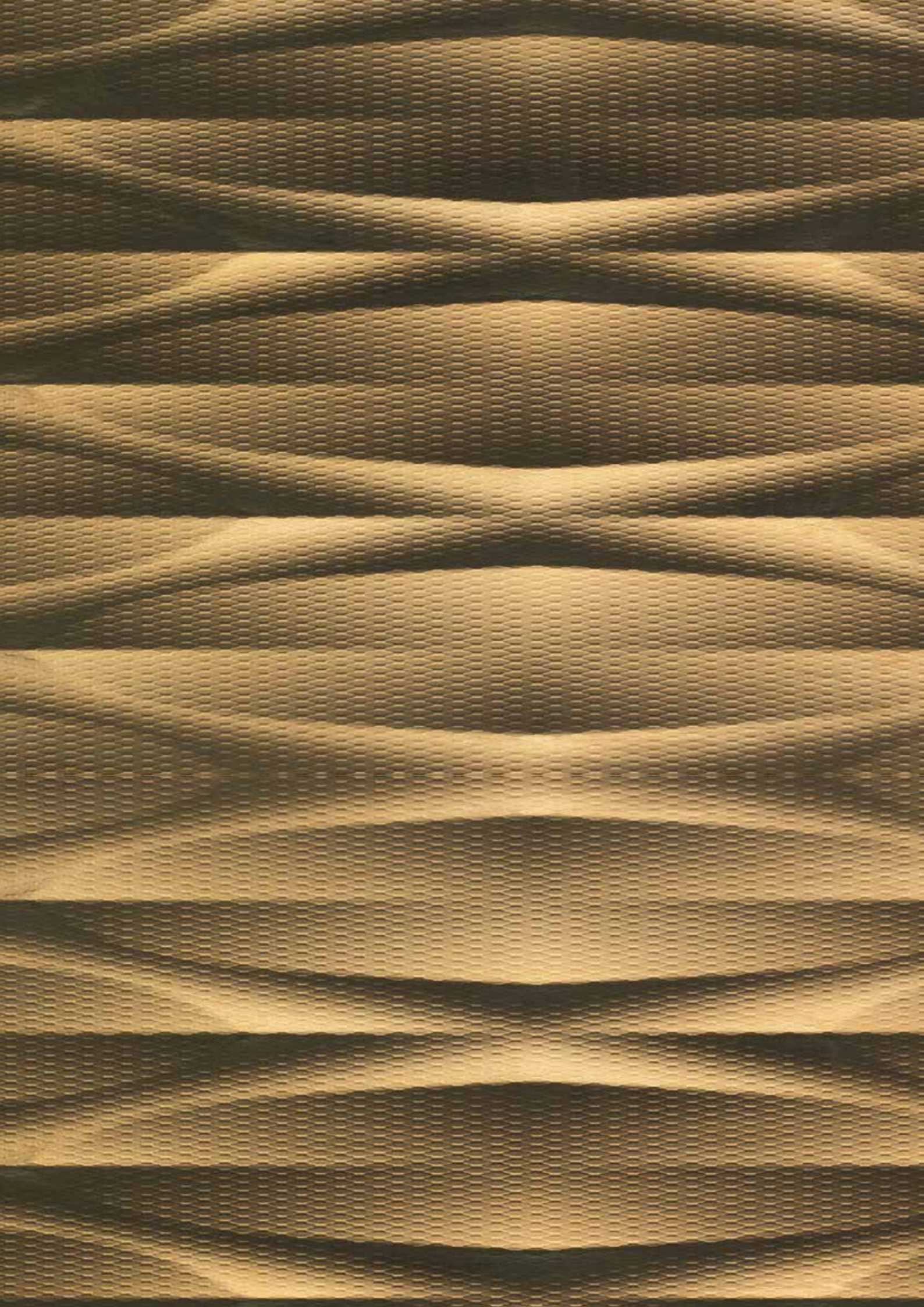

PRO

NATURE

MILLENIUM

Kapladığı her mekânı yeni yüzyılın fütüristik dünyasına dönüştüren seramik serisi. Doğal renklerin ultra modernizmle birlikteliğini sunan millenium, soft ve mat görünümle kontrast yaratan altın, platin, bronz kaplı dekor ve bordürleriyle üç boyutlu bir algı yaratıyor.

A ceramic series transforming every space to the futuristic realm of the new millenium. Combining natural colors with ultra modern designs, millenium creates a three dimensional perception with its golden, silver and platinum decors and borders contrasting with the soft and matt outlook.

Duvar Karoları / Wall Tiles

Yüzey Alternatifleri / Surface Alternatives
Mat / Matt

Fon Ebatları / Basic Tile Sizes
30x60 cm (298x598 mm)

Dekor Ebatları / Decor Sizes
30x60 cm (298x598 mm)
10x60 cm (Bordür/Border)

Fon Renkleri / Basic Tile Colors
Beyaz / White
Açık Vizon / Light Mink
Vizon / Mink
Koyu Kahve / Dark Brown
Antrasit / Anthracite

Uyumlu Yer Karoları / Compatible Floor Tiles
Skyline
Ultra
Uptown

Kullanım Alanları / Usage Areas
Konut / Residential

Döşeme Alanları / Tiling Areas
Duvar / Wall

Dona Dayanım / Frost Resistance
Yok / Not Available

Baskı Teknolojisi / Printing Technology
Reaktif Ink / Reactive Ink

Ürün Standardı / Product Standard
EN14411 Group BIII

Dip Notlar / Footnotes

Ⓑ



Duvar Karosu
Wall Tile



Konut
Residential



Mat
Matt



Rektifiyesiz
Non-Rectified



Reaktif Ink
Reactive Ink



Dekor
Baskı
Decor
Printing

MILLENIUM

Duvar Karoları / Wall Tiles



30x60

Mat / Matt

K92737200001VTE0

Beyaz / White



30x60

Mat / Matt

K92743100001VTE0

Dalga Dekor / Wave Decor
Beyaz / White



30x60

Mat / Matt

K93044100001VTE0t

Açık Vizon / Light Mink



30x60

Mat / Matt

K93045200001VTE0

Dalga Dekor / Wave Decor
Açık Vizon / Light Mink

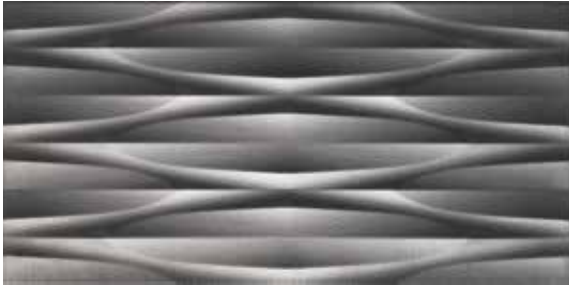

Dalga Dekor / Wave Decor
Platin / Platinum

30x60 Mat / Matt

K08345600001VTE0

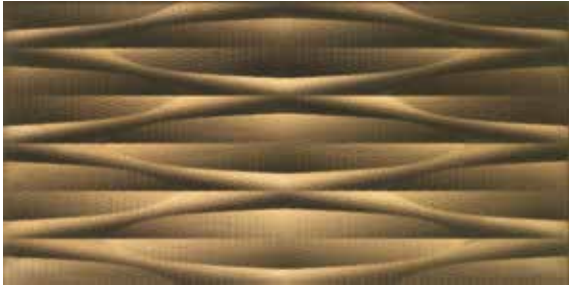

Dalga Dekor / Wave Decor
Altın / Gold

30x60 Mat / Matt

K08344500001VTE0

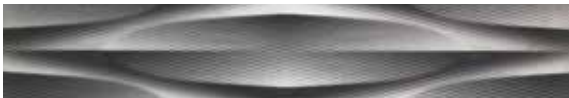

Bordür / Border
Platin / Platinum

10x60 Mat / Matt

K08348200001VTE0



Bordür / Border
Altın / Gold

10x60 Mat / Matt

K08347100001VTE0



Yer Karoları / Floor Tiles : K943051R0001VTE0 20x120 Woodmix Moka / Mocha

Duvar Karoları / Wall Tiles : K94363200001VTE0 30x60 Craftmix Mavi / Blue
K94363900001VTE0 30x60 Craftmix Düz Patchwork Dekor / Regular Patchwork Dekor Mavi / Blue
K94363500001VTE0 30x60 Craftmix Düz Patchwork Dekor / Regular Patchwork Dekor Krem / Cream
K94364000001VTE0 30x60 Craftmix Artisan Patchwork Dekor / Artisan Patchwork Dekor Mavi / Blue
K94363600001VTE0 30x60 Craftmix Artisan Patchwork Dekor / Artisan Patchwork Dekor Krem / Cream

CRAFTMIX





PRO

NATURE

CRAFTMIX

Geleneksel motifleri çağdaş renk alternatifleriyle bir araya getiren seramik serisi. Yoğun dekor kullanımıyla şık ve klasik bir mekân tasarımına olanak veren Craftmix, yalnızca fonları kullanıldığında ise tamamen modern tasarımlı bir yaşam alanı yaratıyor. Hem mutfak hem de banyo kullanımı için ideal olan Craftmix serisi, geleneksel desenleri, parlak yüzeyi ve rölyefli yapısıyla kullanıldığı mekânlara sıcak bir atmosfer kazandırıyor.

A ceramic series recreating traditional motifs into stylish designs thanks to its modern color alternatives. While Craftmix decors create a chic and classic look; the basic tiles of the range create a living space with a very modern design. Ideal for kitchens and bathrooms, Craftmix series provides a warm atmosphere with its traditional design, bright surface and relief structure.

Duvar Karoları / Wall Tiles

Yüzey Alternatifleri / Surface Alternatives
Parlak / Glossy

Fon Ebatları / Basic Tile Sizes
30x60 cm (298x598 mm)

Dekor Ebatları / Decor Sizes
30x60 cm (298x598 mm)
5x30 cm (Bordür / Border)
2x30 cm (Bordür / Border)

Fon ve Dekor Renkleri / Basic Tile and Decor Colors

Krem / Cream
Kum Beji / Sand
Gri / Grey
Mavi / Blue
Koyu Vizon / Dark Mink

Uyumlu Yer Karoları / Compatible Floor Tiles

Woodmix
Clay cement
Urbancrete
Newcon

Kullanım Alanları / Usage Areas

Konut / Residential

Döşeme Alanları / Tiling Areas

Duvar / Wall

Dona Dayanım / Frost Resistance

Yok / Not Available

Baskı Teknolojisi / Printing Technology

ReaLook

Ürün Standardı / Product Standard

EN14411 Group BIII

Dip Notlar / Footnotes

N



Duvar Karosu
Wall Tile



Konut
Residential



Parlak
Glossy



Rektifiyesiz
Non Rectified

CRAFTMIX

Duvar Karoları / Wall Tiles

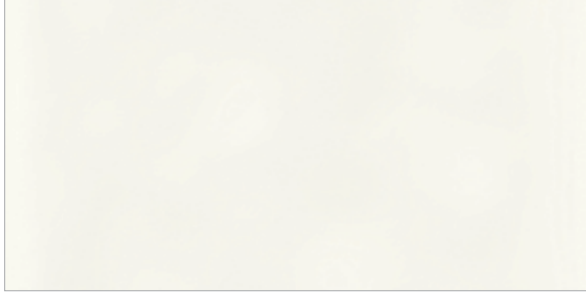

Krem / Cream

30x60 Parlak / Glossy K94362900001VTE0



Kum Beji / Sand

30x60 Parlak / Glossy K94362800001VTE0



Gri / Grey

30x60 Parlak / Glossy K94363100001VTE0



Mavi / Blue

30x60 Parlak / Glossy K94363200001VTE0



30x60 Krem / Cream K94363500001VTE0

Scored Düz Patchwork Dekor / Scored Regular Patchwork Dekor
Krem / Cream



30x60 Koyu Vizon / Dark Mink K94364100001VTE0
30x60 Kum Beji / Sand K94363700001VTE0
30x60 Mavi / Blue K94363900001VTE0

Scored Düz Patchwork Dekor / Scored Regular Patchwork Dekor
Koyu Vizon / Dark Mink



30x60 Krem / Cream K94363600001VTE0

Scored Artisan Patchwork Dekor / Scored Artisan Patchwork Dekor
Krem / Cream



30x60 Koyu Vizon / Dark Mink K94364200001VTE0
30x60 Kum Beji / Sand K94363800001VTE0
30x60 Mavi / Blue K94364000001VTE0

Scored Artisan Patchwork Dekor / Scored Artisan Patchwork Dekor
Koyu Vizon / Dark Mink

	2x30	Parlak / Glossy	Kum Beji / Sand	K94365200001VTE0
Bordür / Border	2x30	Parlak / Glossy	Krem / Cream	K94365300001VTE0
Kum Beji / Sand	2x30	Parlak / Glossy	Gri / Grey	K94365000001VTE0
	2x30	Parlak / Glossy	Mavi / Blue	K94365700001VTE0



Duvar Karoları / Wall Tiles :

K94388200001VTE0 10x30 Homemade Klasik Çerçeve Dekor / Classic Frame Decor Açık Somon / Powder
K94388500001VTE0 10x30 Homemade Açık Somon / Powder

HOMEMADE





PRO

NATURE

HOMEMADE

Rustik bir mekân ya da retro tarzı modern bir loft ambiyans yaratmak için ideal, klasiğin modern yorumu olan seramik serisi. Bu karo serisi, son senelerde oldukça popüler olan tuğla stilinin bir yansıması olarak 10x30 cm parlak ve rölyefli yüzeylere sahip. Göz alıcı renklerdeki fonları ve 3D rölyefli dekorları ile Homemade düz, kaydırmalı, zikzak ve balıksırtı döşenerek banyo ve mutfaklar için farklı tasarım alternatifleri sunuyor.

A ceramic series enabling creation of a rustic space or a modern loft ambiance in retro style. This new tile series has 10x30 cm, bright and relief surfaces as a reflection of brick style, which is highly popular in recent years. With basic tiles in spectacular colors and decors with 3D reliefs, Homemade offers a lot of different design alternatives for bathrooms and kitchens through flat, sliding, zigzag and herringbone tiling.

Duvar Karoları / Wall Tiles

Yüzey Alternatifleri / Surface Alternatives

Parlak / Glossy

Fon Ebatları / Basic Tile Sizes

10x30 cm (97x297 mm)

Dekor Ebatları / Decor Sizes

10x30 cm (97x297 mm)

Fon ve Dekor Renkleri / Tile and Decor Colors

Krem / Cream

Gri / Grey

Açık Somon / Powder

Kum Beji / Sand

Uyumlu Yer Karoları / Compatible Floor Tiles

Woodmix

Samba

Clay cement

Urbancrete

Newcon

Kullanım Alanları / Usage Areas

Konut / Residential

Döşeme Alanları / Tiling Areas

Duvar / Wall

Dona Dayanım / Frost Resistance

Yok / Not Available

Ürün Standardı / Product Standard

10X30 EN14411 BIII



Duvar Karosu
Wall Tile



Konut
Residential



Ödüllü
Award Winning



Parlak
Glossy



Rektifiyesiz
Non Rectified



GOOD DESIGN
AWARD 2016

HOMEMADE

Duvar Karoları / Wall Tiles

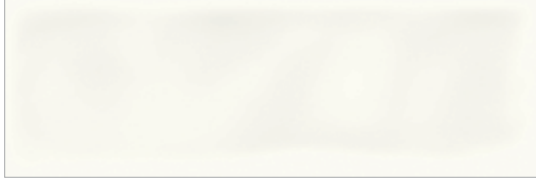

10x30 Parlak / Glossy K94359200001VTE0

Krem / Cream



10x30 Parlak / Glossy K94360500001VTE0

Gri / Grey



10x30 Parlak / Glossy K94358400001VTE0

Kum Beji / Sand



10x30 Parlak / Glossy K94388500001VTE0

Açık Somon / Powder



10x30 Parlak / Glossy K94358800001VTE0

Klasik Çerçeve Dekor / Classic Frame Decor
Krem / Cream



10x30 Parlak / Glossy K94360200001VTE0

Klasik Çerçeve Dekor / Classic Frame Decor
Gri / Grey



10x30 Parlak / Glossy K94358100001VTE0

Klasik Çerçeve Dekor / Classic Frame Decor
Kum Beji / Sand



10x30 Parlak / Glossy K94388200001VTE0

Klasik Çerçeve Dekor / Classic Frame Decor
Açık Somon / Powder

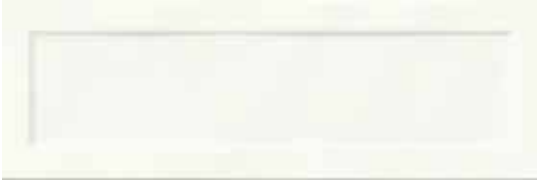

10x30 Parlak / Glossy K94358900001VTE0

Düz Çerçeve Dekor / Regular Frame Decor
Krem / Cream

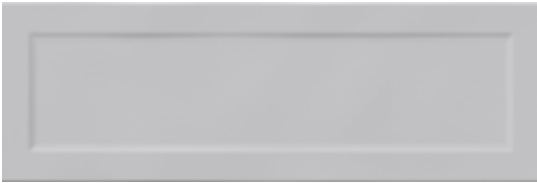

10x30 Parlak / Glossy K94360300001VTE0

Düz Çerçeve Dekor / Regular Frame Decor
Gri / Grey



10x30 Parlak / Glossy K94358200001VTE0

Düz Çerçeve Dekor / Regular Frame Decor
Kum Beji / Sand



10x30 Parlak / Glossy K94388300001VTE0

Düz Çerçeve Dekor / Regular Frame Decor
Açık Somon / Powder



MINER'S MUD SOAP BAR
all-day + mud bath + wash
PROSPECTOR CO.

FUTURA - M

Yer Karoları / Floor Tiles : K93299400001VTE0 15x90 Woodplus K.Gri / D.Grey

Duvar Karoları / Wall Tiles : K94421600001VTE0 30x60 Futura - M Beyaz / White
K94697600001VTE0 30x60 Futura - M Antrasit / Anthracite
K94697700001VTE0 30x60 Futura - M 3D Dalga Dekor / 3D Wave Decor Antrasit / Anthracite

PRO

NATURE

FUTURA - M

Duvar Karoları / Wall Tiles

Yüzey Alternatifleri / Surface Alternatives
Mat / Matt

**Fon ve Dekor Ebatları /
Basic and Decor Tile Sizes**
30x60 cm (298x598 mm)

Fon Renkleri / Basic Tile Colors
Beyaz / White
Antrasit / Anthracite

Uyumlu Yer Karoları / Compatible Floor Tiles
Ceppostone
Urbancrete
Urbanwood
Newcon
Woodplus

Kullanım Alanları / Usage Areas
Konut / Residential

Döşeme Alanları / Tiling Areas
Duvar / Wall

Dona Dayanım / Frost Resistance
Yok / Not Available

Ürün Standardı / Product Standard
EN14411 Group BIII

Dip Notlar / Footnotes
®





Duvar Karosu
Wall Tile

Konut
Residential

Mat
Matt

Rektifiyesiz
Non Rectified

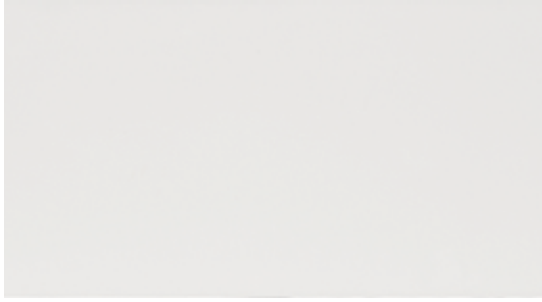
Duvar Karoları / Wall Tiles



Beyaz / White

30x60

Mat / Matt

K94421600001VTE0



Antrasit / Anthracite

30x60

Mat / Matt

K94697600001VTE0

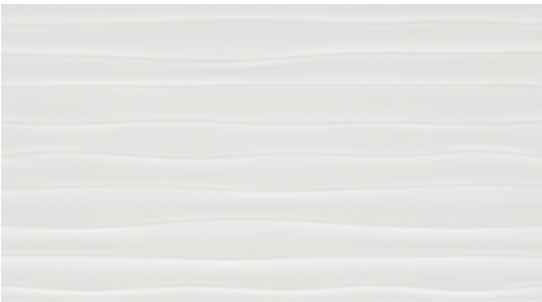

3D Dalga Dekor / 3D Wave Decor
Beyaz / White

30x60

Mat / Matt

K94417200001VTE0



3D Dalga Dekor / 3D Wave Decor
Antrasit / Anthracite

30x60

Mat / Matt

K94697700001VTE0



ELEGANT

Yer Karoları / Floor Tiles : K83231400001VTE0 45x45 Elegant Moka / Mocha

Duvar Karoları / Wall Tiles : K83228100001VTE0 25x40 Elegant Krem / Cream
K84077300001VTE0 25x40 Elegant Scored Moka / Mocha
K83227000001VTE0 25x40 Elegant Moka / Mocha

Duvar Karoları / Wall Tiles

**Fon ve Dekor Ebatları /
Basic Tile and Decor Sizes**
25x40 cm

Yüzey Alternatifleri / Surface Alternatives
Mat / Matt

**Fon ve Dekor Renkleri /
Basic Tile and Decor Colors**
Beyaz / White
Krem / Cream
Moka / Mocha
Antrasit / Anthracite

Kullanım Alanları / Usage Areas
Konut / Residential

Döşeme Alanları / Tiling Areas
Duvar / Wall

Dona Dayanım / Frost Resistance
Yok / Not Available

Baskı Teknolojisi / Printing Technology
Rotocolor

Ürün Standardı / Product Standard
EN14411 Group BIII

PRO

NATURE

ELEGANT

Değerli metallerin sürükleyici dokusunu mekânlara yansıtan Elegant serisi, altın, bakır ve bronz renklerini beyaz, siyah ve bej tonlarıyla buluşturuyor. Sıcak, yumuşak ve mat renkler uyumlu bir araya gelerek fark yaratan yüzeyler oluşturuyor.

Elegant series reflects the absorbing outlook of precious metals to spaces by combining golden, copper and bronze colors with white, black and beige hues. Warm, soft and matt colors come together in harmony to create distinguished surfaces.



Duvar Karosu
Wall Tile



Konut
Residential



Mat
Matt



Rektifiyesiz
Non Rectified

Porselen Karolar / Porcelain Tiles

Bünye / Body Type

Sırlı Porselen / Glazed Porcelain

Yüzey Alternatifleri / Surface Alternatives

Mat / Matt

Fon Ebatları / Basic Tile Sizes

45x45 cm (447x447 mm)

Fon Renkleri / Basic Tile Colors

Beyaz / White

Krem / Cream

Moka / Mocha

Antrasit / Anthracite

Kullanım Alanları / Usage Areas

Konut / Residential

Döşeme Alanları / Tiling Areas

Yer / Floor

Dona Dayanım / Frost Resistance

Var / Available

Baskı Teknolojisi / Printing Technology

Rotocolor

Ürün Standardı / Product Standard

EN14411 Group Bla



Porselen
Porcelain



Yer Karosu
Floor Tile



Konut
Residential



Dona Dayanım
Frost Resistance



Mat
Matt



Rektifiyesiz
Non Rectified

ELEGANT

Duvar Karoları / Wall Tiles



25x40 Mat / Matt K83230300001VTEO

Beyaz / White



25x40 Mat / Matt K83228100001VTEO

Krem / Cream



25x40 Mat / Matt K83229200001VTEO

Antrasit / Anthracite



25x40 Mat / Matt K83227000001VTEO

Moka / Mocha



Beyaz / White	25x40	Mat / Matt	K84068100001VTEO
Krem / Cream	25x40	Mat / Matt	K84069200001VTEO
Antrasit / Anthracite	25x40	Mat / Matt	K84076200001VTEO
Moka / Mocha	25x40	Mat / Matt	K84077300001VTEO

Scored
Moka / Mocha



7,5x25 Mat / Matt K93203600001VTEO

Bull
Moka / Mocha

Porselen Karolar / Porcelain Tiles



Beyaz / White

45x45

Mat / Matt

K83236200001VTEO



Krem / Cream

45x45

Mat / Matt

K83232500001VTEO



Antrasit / Anthracite

45x45

Mat / Matt

K83235100001VTEO



Moka / Mocha

45x45

Mat / Matt

K83231400001VTEO



DÜZ RENKLER / PLAIN COLORS



Yer Porselen Karoları / Floor Porcelain Tiles : K945691R0001VTE0 20x120 Aspenwood Koyu Gri / Dark Grey

Duvar Karoları / Wall Tiles

: K939294R0001VTS0 33x100 Mat Beyaz / White

Duvar Karoları / Wall Tiles

Yüzey Alternatifleri / Surface Alternatives

Mat / Matt

Parlak / Glossy

Fon ve Dekor Ebatları / Basic and Decor Tile Sizes

33x100 cm (R 329x991 mm)

25x70 cm (R 247x697 mm)

30x60 cm (298x598 mm)

20x60 cm (198x598 mm)

20x50 cm (198x498 mm)

25x40 cm (248x398 mm)

20x30 cm (198x298 mm)

20x25 cm (198x248 mm)

20x20 cm (198x198 mm)

Fon ve Dekor Renkleri / Basic Tile and Decor Colors

Beyaz / White

Siyah / Black

Kullanım Alanları / Usage Areas

Konut / Residential

Ticari Alan / Commercial

Döşeme Alanları / Tiling Areas

Duvar / Wall

Dona Dayanım / Frost Resistance

Yok / Not Available

Baskı Teknolojisi / Printing Technology

ReaLook

Ürün Standardı / Product Standard

EN14411 Group BIII



Duvar Karosu
Wall Tile



Konut
Residential



Mat
Matt



Parlak
Glossy

PRO

NATURE

DÜZ RENKLER / PLAIN COLORS

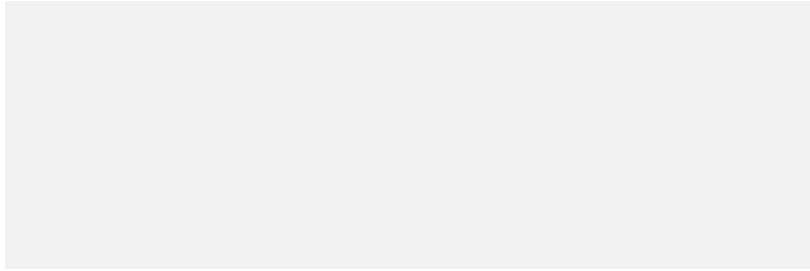

33x100 Mat / Matt
33x100 Parlak / Glossy

K939294R0001VTSO
K944998R0001VTSO

Beyaz / White

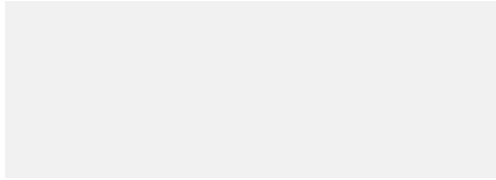

25x70 Mat / Matt
25x70 Parlak / Glossy

K912554R0001VTEO
K944971R0001VTEO

Beyaz / White

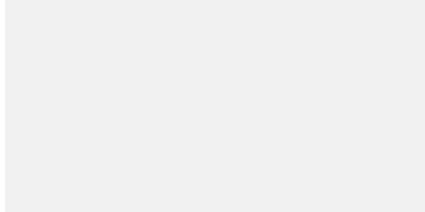

30x60 Mat / Matt
30x60 Mat / Matt
30x60 Mat / Matt

K82304200001VTEO
K823042R0001VTEO
K823042B0001VTEO

30x60 Parlak / Glossy
30x60 Parlak / Glossy
30x60 Parlak / Glossy

K82305300001VTEO
K823053R0001VTEO
K823053B0001VTEO

Beyaz / White

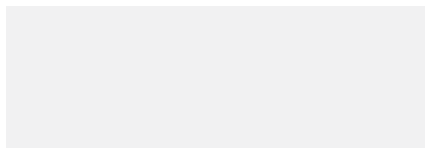

20x60 Mat / Matt
20x60 Mat / Matt

K92843300001VTEO
K928433B0001VTEO

20x60 Parlak / Glossy
20x60 Parlak / Glossy

K92842200001VTEO
K928422B0001VTEO

Beyaz / White

DÜZ RENKLER / PLAIN COLORS

Duvar Karoları / Wall Tiles

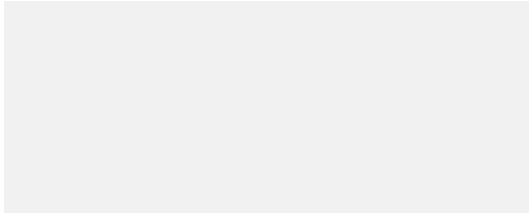

20x50	Mat / Matt	K86914400001VTE0
20x50	Parlak / Glossy	K87021600001VTE0
20x50	Parlak / Glossy	K870216B0001VTE0

Beyaz / White

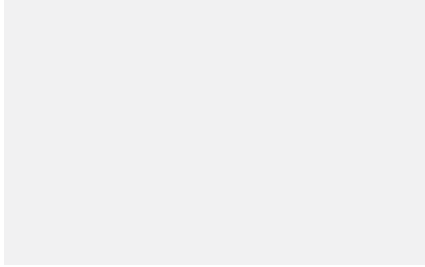

25x40	Mat / Matt	K82241200001VTE0
25x40	Mat / Matt	K822412B0001VTE0
25x40	Parlak / Glossy	K81629500001VTE0
25x40	Parlak / Glossy	K816295B0001VTE0

Beyaz / White

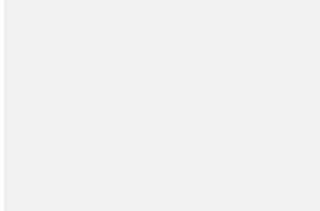

20x30	Mat / Matt	K77710300001VTE0
20x30	Mat / Matt	K777103B0001VTE0
20x30	Parlak / Glossy	K77032400001VTE0
20x30	Parlak / Glossy	K770324B0001VTE0

Beyaz / White

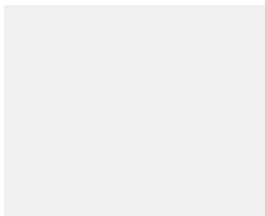

20x25	Mat / Matt	K94775000001VTE0
20x25	Parlak / Glossy	K94775200001VTE0

Beyaz / White

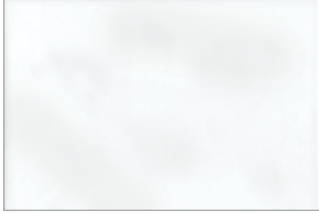

20x30 Parlak / Glossy K77094300001VTEo
20x30 Parlak / Glossy K770943B0001VTEo

Rölyef / Relief
Beyaz / White



20x20 Parlak / Glossy K94775100001VTEo

Rölyef / Relief
Beyaz / White



25x40 Parlak / Glossy K86739400001VTEo

Siyah / Black



METRO TILES





PRO

NATURE

METRO TILES

Formların ve çizgilerin göz alıcı simetrisiyle, kullanıldığı her yere güçlü ve özgüvenli bir atmosfer kazandıran seramik koleksiyonu. Metro Tiles; siyah, beyaz, gri, krem ve altın renk seçenekleri yanında belirgin formuyla da kendine özgü karakterini kullanıldığı duvarlara yansıtıyor. Klasiğin, modası geçmeyen güzelliğini sade ve modern tasarımıyla dengeleyen koleksiyonda 2.5x5, 5x10, 10x10, 10x20, 10x30 ve 20x20 cm ebat seçenekleri bulunuyor.

A ceramic collection that brings a strong and confident atmosphere wherever it is used with eye-catching symmetry of forms and lines. Metro Tiles reflects its unique character on the walls with black, white, grey, cream and gold colour options as well as distinctive forms. The collection that balances the timeless beauty of classic with simple and modern design, is available in 2.5x5, 5x10, 10x10, 10x20, 10x30 and 20x20 cm sizes.

Seramik Yer Karosu / Ceramic Floor Tiles

Yüzey Alternatifleri / Surface Alternatives

Parlak / Glossy

Fon Ebatları / Basic Tile Sizes

M2.5X5 cm (23X47 mm)
M5X10 cm (47X97 mm)
M10X10 cm (97X97 mm)
M10X20 cm (97X197 mm)
M10X30 cm (97X197 mm)
M20X20 cm (197X197 mm)

Dekor Ebatları / Decor Sizes

M10X20 cm (97X197mm)
M20X20 cm (197X197 mm)

Fon Renkleri / Basic Tile Colors

Vizon / Mink
Beyaz / White
Siyah / Black
Krem / Cream
Gri / Grey

Dekor Renkleri / Decor Colors

Altın / Gold

Kullanım Alanları / Usage Areas

Konut / Residential
Ticari Alan / Commercial

Döşeme Alanları / Tiling Areas

Yer / Floor
Duvar / Wall

Desen Farklılaşması / Shade Variation Classification

VO

Dona Dayanım / Frost Resistance

Var / Available

Ürün Standardı / Product Standard

EN14411 Group B1b



Yer Karosu
Floor Tile



Duvar Karosu
Wall Tile



Konut
Residential



Dona Dayanım
Frost Resistance



Parlak
Glossy



Rektifiyesiz
Non Rectified



Ticari Alan
Commercial

METRO TILES

Seramik Yer Karosu / Ceramic Floor Tiles



2,5x5 cm Glossy / Parlak K52356080001VTE0

Beyaz / White



2,5x5 cm Glossy / Parlak K53509580001VTE0

Krem / Cream

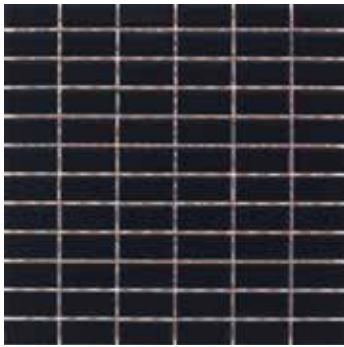

2,5x5 cm Glossy / Parlak K52357180001VTE0

Siyah / Black

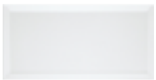

5x10 cm Glossy / Parlak K52358280001VTE0

Beyaz / White



5x10 cm Glossy / Parlak K53247280001VTE0

Krem / Cream



5x10 cm Glossy / Parlak K52359380001VTE0

Siyah / Black



20x20 cm Siyah / Black

Glossy / Parlak

K94528800001VTE0



10x30 cm Siyah / Black

Glossy / Parlak

K94529100001VTE0



10x20 cm Siyah / Black

Glossy / Parlak

K94530500001VTE0



10x10 cm Siyah / Black

Glossy / Parlak

K94528380001VTE0

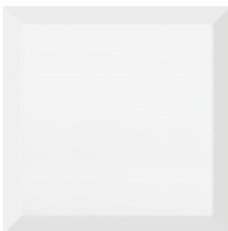

20x20 cm Beyaz / White

Glossy / Parlak

K94528700001VTE0

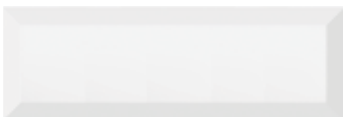

10x30 cm Beyaz / White

Glossy / Parlak

K94529000001VTE0

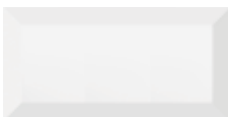

10x20 cm Beyaz / White

Glossy / Parlak

K94530400001VTE0



10x10 cm Beyaz / White

Glossy / Parlak

K94528280001VTE0

METRO TILES

Seramik Yer Karosu / Ceramic Floor Tiles



20x20 cm Krem / Cream Glossy / Parlak K94528900001VTE0



10x30 cm Krem / Cream Glossy / Parlak K94529200001VTE0



10x20 cm Krem / Cream Glossy / Parlak K94528500001VTE0



10x10 cm Krem / Cream Glossy / Parlak K94528480001VTE0



20x20 cm Gri / Grey Glossy / Parlak K94759900001VTE0



10x30 cm Gri / Grey Glossy / Parlak K94760000001VTE0



10x20 cm Gri / Grey Glossy / Parlak K94759800001VTE0



10x10 cm Gri / Grey Glossy / Parlak K94759780001VTE0



10x20 cm Altın / Gold

Glossy / Parlak K94528600001VTE0



20x20 cm Altın / Gold

Glossy / Parlak K94551300001VTE0



COLOR LINE



MENU

SIDES
turkey, pork
seasonal vegetables

ENTRIES
eggplant rollatini
chicken, farofa
salmon

CARVING STATION
prime rib turkey
enjoy! Dan & Michael



PRO

NATURE

COLOR LINE

Mozaiğin zamansız güzelliğini, mavi, sarı, yeşil ve gri tonlarının doğal renk geçişleriyle zenginleştirilmiş kombinasyonlarında bir araya getiren seramik koleksiyonu Colorline, banyolardan mutfaklara, spor tesislerinden havuzlara farklı kullanım alanlarını mozaığın renkli dünyasıyla canlandırıyor.

A ceramic collection that combines the timeless beauty of mosaics with shades of blue, yellow, green and grey enriched with natural colour transitions. Colorline enlivens different areas of use from bathrooms to kitchens or sports facilities to pools, reflecting the colourful atmosphere of mosaics. The collection, which creates unique spaces with its flexible tiling possibilities and timeless aesthetics, is available in dimensions of 2.5x2.5 and 5x5 cm.

Porselen Karolar / Porcelain Tiles Seramik Yer Karoları / Ceramic Floor Tiles

Yüzey Alternatifleri / Surface Alternatives
Parlak / Glossy

Fon Ebatları / Basic Tile Sizes
M2.5X2.5 cm (23X23 mm)
M5X5 cm (47X47 mm)

Fon Renkleri / Basic Tile Colors
Yeşil-Mavi / Green-Blue
Sarı-Mavi / Yellow-Blue
Havuz Mavi / Pool Blue
Gri / Grey
K. Mavi-Yeşil / D. Blue-Green

Kullanım Alanları / Usage Areas
Konut / Residential
Ticari Alan / Commercial

Döşeme Alanları / Tiling Areas
Yer / Floor
Duvar / Wall

Dona Dayanım / Frost Resistance
Var / Available

Ürün Standardı / Product Standard
M 2.5X2.5cm EN 14411 Group Bla
M 5X5cm EN 14411 Group Blb



Yer Karosu
Floor Tile



Duvar Karosu
Wall Tile



Konut
Residential



Porselen
Porcelain



Dona Dayanım
Frost Resistance



Parlak
Glossy



Rektifiyesiz
Non Rectified



Ticari Alan
Commercial

COLOR LINE

Porselen Karolar / Porcelain Tiles

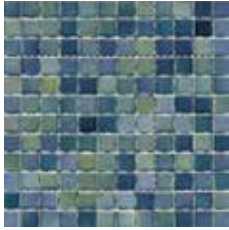

2,5x2,5 cm Parlak / Glossy K02908180001VTE0

Yeşil-Mavi / Green-Blue

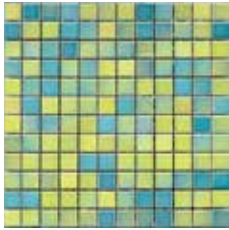

2,5x2,5 cm Parlak / Glossy K02947580001VTE0

Sarı-Mavi / Yellow-Blue

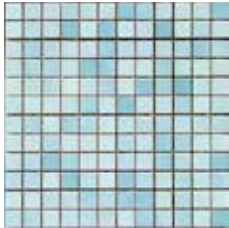

2,5x2,5 cm Parlak / Glossy K02948680001VTE0

Havuz Mavi / Pool Blue

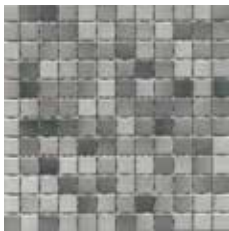

2,5x2,5 cm Parlak / Glossy K51149380001VTE0

Gri / Grey

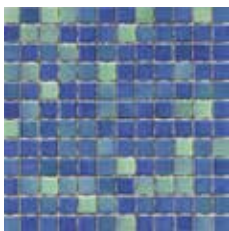

2,5x2,5 cm Parlak / Glossy K51291680001VTE0

K. Mavi-Yeşil / D. Blue-Green

Seramik Yer Karoları / Ceramic Floor Tiles

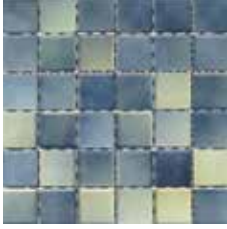

5x5 cm

Parlak / Glossy K50898280001VTE0

Yeşil-Mavi / Green-Blue

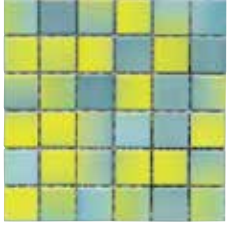

5x5 cm

Parlak / Glossy K51049040001VTE0

Sarı-Mavi / Yellow-Blue



5x5 cm

Parlak / Glossy K51050180001VTE0

Havuz Mavi / Pool Blue

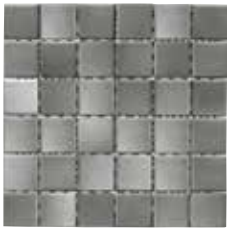

5x5 cm

Parlak / Glossy K51150480001VTE0

Gri / Grey

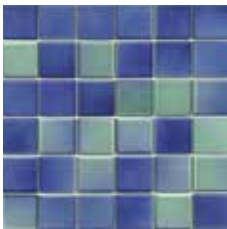

5x5 cm

Parlak / Glossy K51292080001VTE0

K. Mavi-Yeşil / D. Blue-Green



DAY-TO-DAY





PRO

NATURE

DAY-TO-DAY

Mozaiğin asırlardır modası geçmeyen estetiğini, modern ebat ve renk kombinasyonları ile günümüzün tasarım trendlerine uyarlayan Day-to-Day koleksiyonu, üç boyutlu yüzeyleri ile kullanıldığı tüm alanlara akışkanlık ve dinamizm kazandırarak tasarımcıların yaratıcı duvarlar ortaya çıkarmasına yardımcı oluyor. Beyaz ve mavi tonlarındaki mozaik görünümlü koleksiyon, farklı ebatların bir arada döşendiği yenilikçi tarzıyla zevkli mekânlar yaratıyor.

A ceramic collection that adapts the conventional aesthetics of mosaics to contemporary design trends with its modern size and colour combinations. Three-dimensional lively surfaces of Day-to-Day collection help designers to create fluid and dynamic walls. The mosaic-patterned collection with its white-blue shades and size variations, creates refined spaces with innovative style.

Seramik Yer Karoları / Ceramic Floor Tiles

Yüzey Alternatifleri / Surface Alternatives
Parlak / Glossy

Fon Ebatları / Basic Tile Sizes
M30X30 cm (23X23 mm / 47X97 mm / 97X97mm)

Fon Renkleri / Basic Tile Colors
Beyaz / White
Aqua Mavi / Aqua Blue

Kullanım Alanları / Usage Areas
Konut / Residential
Ticari Alan / Commercial

Döşeme Alanları / Tiling Areas
Yer / Floor
Duvar / Wall

Dona Dayanım / Frost Resistance
Var / Available

Ürün Standardı / Product Standard
EN14411 Group Bıb



Yer Karosu
Floor Tile



Duvar Karosu
Wall Tile



Konut
Residential



Dona Dayanım
Frost Resistance



Parlak
Glossy



Rektifiyesiz
Non Rectified



Ticari Alan
Commercial



DAY-TO-DAY

Seramik Yer Karoları / Ceramic Floor Tiles



30x30 cm Parlak / Glossy K54005480001VTE0

Beyaz / White



30x30 cm Parlak / Glossy K54008080001VTE0

Aqua Mavi / Aqua Blue



TECHNICAL INFORMATION

TEKNİK BİLGİLER

Dipnotlar / Footnotes

- A** Kesme bordürler rektifiye edilmemiş karolarla kullanılmalıdır.
Cut borders must be set together with non-rectified tiles.
- B** Ürünlerin üzeri metalik sırla kaplanmıştır. Bronz, altın ve platin gibi metalik sırlı ürünlerin çizilme ve asit direnci normal sırlardan düşüktür. Günlük temizlik için lütfen ürününüzü temiz su, cam-sil veya sıvı bulaşık deterjanı ile temizleyiniz ve temizledikten sonra yumuşak bezle siliniz. Lütfen sırlı yüzeyin asidik ve daha sert bir malzeme veya toz deterjanla temasını önleyiniz.
The products are coated with metallic glazes. Scratch and acid resistance of metallic glazes is lower than ordinary glazes. Please clean with pure water, liquid regular glass cleaner or dish washing liquids only by using a soft cloth. Please avoid contact with acidic or harder materials or powders.
- C** Karo yüzeyi Vitra clean kaplanmıştır. Vitra clean kaplı ürünler yer karosu olarak kullanılamaz.
Surface of the tile is covered with special glaze Vitra clean. Vitra clean coated products are not suitable for floor.
- E** Mozaik ürünleri sipariş verirken, kodun sonuna aşağıdaki seçeneklerden birisi eklenmelidir
4 Kağıt file
7 Dot mounted
8 Naylon file
Please add one of the below options at the end of the mosaic code.
4 Paper net
7 Dot mounted
8 Nylon net
- F** Duvar ve yer karosu olarak kullanılabilir.
Suitable for both wall and floor.
- G** Hareket yoğunluğu fazla olan yerlerde kullanılmamalıdır
It is not suitable for heavy traffic areas
- H** Gerçek doğal taş, mermer, ahşap veya beton görünümü vermek için ürünlerin herbiri birbirinden farklı tonlarda ve bazen de farklılaşan desenlerde üretilmiştir.
Each tile has different shades of the color and slightly different designs to give real natural stone, marble, wood or cement impression.
- I** Kesme bordürler için sipariş girilirken, birlikte kullanılacak olan porselen karonun rektifiye yada rektifiyesiz olduğu mutlaka belirtilmelidir.
When ordering cut borders please specify whether the tile, which will be used with the border, is rectified or non-rectified.
- K** 8,5x45 ve 8,5x60 ebatında süpürgelik siparişi girileceği zaman birlikte kullanılacak yer karolarının mat, lappatto, lappatto rektifiye özelliklerinden hangisine sahip olduğu mutlaka belirtilmelidir.
When ordering plinths in 8,5x45 and 8,5x60 format, please specify the characteristics of the tile, which will be used with the plinth, such as matte, lappato, rectified, lappato rectified, etc.
- M** **Cam Karolar**
Kesme/Delme: Lütfen sadece sulu elmas ile kesim yapınız. Delme işlemi sulu, çift yönlü ve düşük devirde yapılmalıdır
Döşeme: Cam ürünleri döşerken Flex Porcelain Rapid Yapıştırıcı veya Porselen Yapıştırıcı kullanınız. Bronz, Altın ve Platin renkli cam ürünlerin döşemesinde Gri Flex Rapid Yapıştırıcı, diğer tüm renklerde Beyaz Flex Rapid Yapıştırıcı uygulanmalıdır. Arada hava boşluğu kalmaması için ince dişli tarak kullanılmalıdır. Ürünlerin yapıştırılmasında silikon kullanmayınız. Döşeme sırasında karonun arka kısmının tamamını yapıştırıcı kaplı olması gerekmektedir
Uyarı: Cam ürünlerin döşemesinde yapıştırıcı olarak Vitra Fix Flex Rapid veya Porselen yapıştırıcı kullanılması gerekir. Vitra Fix HP ile yapıştırmayınız
Temizlik: Günlük temizlik için lütfen ürününüzü cam-sil veya temiz su ile temizledikten sonra yumuşak bezle siliniz.
Glass Tiles
Cutting / Perforation: Tiles shall be cut using a cutting saw equipped with a diamond disk and ensuring water supply. Perforation shall be performed in both directions, at low speed and with water supply.
Tile Laying: When laying glass products you should use an adhesive composition for porcelain or Porcelain Rapid (the short-acting adhesive composition for porcelain). When laying glass products of bronze, golden or platinum colors you should use the adhesive composition named Gri Flex Rapid, for products of any other color-the adhesive composition named Beyaz Flex Rapid. In order to avoid formation of air gaps you should use a fine-tooth comb. In the course of laying the whole back surface of a tile shall be covered with an adhesive composition.
Warning: When laying glass products you should use an adhesive composition for porcelain or Vitra Fix Flex Rapid. Don't use the adhesive composition named Vitra Fix HP.
Cleaning: For the daily cleaning: Please clean your product with a soft fabric/cloth, after cleaning it with "cam-sil" or with the clean water.

- N** Karolara, mozaik görüntüsü vermek için, üzerine kanallar açılmıştır. İçinde görülen karo bünyesidir. Döşendikten sonra mutlaka derz dolgu verilmelidir.
The tiles are scored to give a mosaic look. They should be grouted after installation.
- P** **VitrA Protect Malzeme Temizliği**
Karolar kirlenmeye karşı önlem olarak VitrA Protect teknolojisi ile kaplanmış olup, yüzeyde görülen matlık uygulanan koruyucu malzeme sebebiyledir. Karolar, döşeme ve derz uygulama sonrası yüzey temizliği yapılmasıyla parlak görüntüsüne kavuşacaktır. Döşeme sonrası karo yüzeyleri yeşil renkli sünger (örneğin 3M yeşil sünger) ile mineral katkılı krem temizlik malzemeleri (örneğin Viss Scheuer Milch Citrus) kullanılarak cam siler gibi dairesel hareketlerle orta sertlikte ovalanarak yüzeyden alınabilir. Büyük mekan uygulamalarında döner fırça yardımıyla benzer şekilde yüzey temizliği sağlanabilir.
VitrA Protect Material Removing
VitrA Protect process is an additional treatment carried out at the manufacturing stage for polished tiles. The process eliminates the need for time-consuming anti-staining treatments at the laying stage.
Due to this process, the tiles with VitrA Protect have a thin film layer. After installation of the tiles, it can be removed by using mineral added cream cleaning agent (such as Viss Scheuer Milch Citrus, Cif Cream or similar) and a mid-hard (green) sponge (such as 3M green sponge or similar). The tiles must be scrubbed in circular motion. For wide areas, brushing machine can be used to clean the film using the same kind of sponge and cleaning agents specified above.
- R** Ürünlerin kenarları rektifiye edilmiştir.
The edges are rectified.
- S** Ürünlerin yüzeyi kaymazlık özelliği nedeniyle rölyefli ve strüktürlüdür. Bu tip yüzeylerin temizlenmesi düz yüzeylere göre daha zordur. Derz uygulaması biter bitmez, yüzeyin sünger kullanarak bol suyla temizlenmesi çok önemlidir. Bu işlem zemin tamamen temizlenene kadar tekrar edilmelidir.
Due to their special features, rough or structured anti-slip surfaces are harder to clean. After the grouting, it is important to remove the excesses in a short time and by frequent washing with sponge and water, till the floor is perfectly clean.
- T** Ürünlerin üzerinde metalik sır vardır. Metalik yüzeyin ışıkla yansıma yapmasından dolayı, aynı kutudan çıkan ürünler arasında matlık-parlaklık, açıklık-koyuluk gibi farklar görülebilmektedir.
The product has a metallic glaze. Due to the reflection of light, there can be differences in color and surface mattness-glossiness of products from the same box.
- U** Dekorların üzerindeki özel teknik nedeniyle, karo yüzeyinde, eskitilmiş etkisi görülebilir.
Due to special technique on the decors, there can be worn out effect on the tiles.

Dikkat - Attention

Seramik karoları sipariş ederken kullanım alanlarını belirtiniz.
Seramik karoları döşmeden önce lütfen tonalite ve kalibre numaralarının aynı mekanlar için aynı olmasına dikkat ediniz; döşendikten sonra sorumluluk kabul edilmez.
Camsı bordürlerde Kraküle (çatlama) olabile, seramiğin doğasında olan bir unsurdur.
VitrA Karo Seramikleri ile birlikte VitrA Fix derz dolgu ve yapıştırıcı malzemeleri kullanılması önerilir.
Katalogdaki ürün renkleri seramik karoların renklerini aynen yansıtmayabilir.
Tamamlayıcı parçası ve ya dekoru olan ürünlerde ana fonu ile ton farklılıkları görülebilir.
VitrA Karo San. ve Tic. A.Ş.'nin ürünler ve teknik detaylarında değişiklik yapma hakkı saklıdır.

When ordering ceramic tiles specify the areas of use.
Before tile setting, verify the tonality and calibration numbers, claims regarding these indications cannot be accepted after tile setting.
Crazing of glass borders is a nature of the ceramic tiles.
It is recommended to use VitrA Fix grout and adhesive materials with VitrA Ceramic Tiles.
The colors of tiles in the catalogue may not reflect the exact colors of the products.
For items with complimentary parts or decors, there may occur color tone diversity with plain background.
VitrA Karo San. ve Tic. A.Ş. reserves the right to change the products and technical specifications.

Döşeme Seçenekleri / Tiling Option

33x100

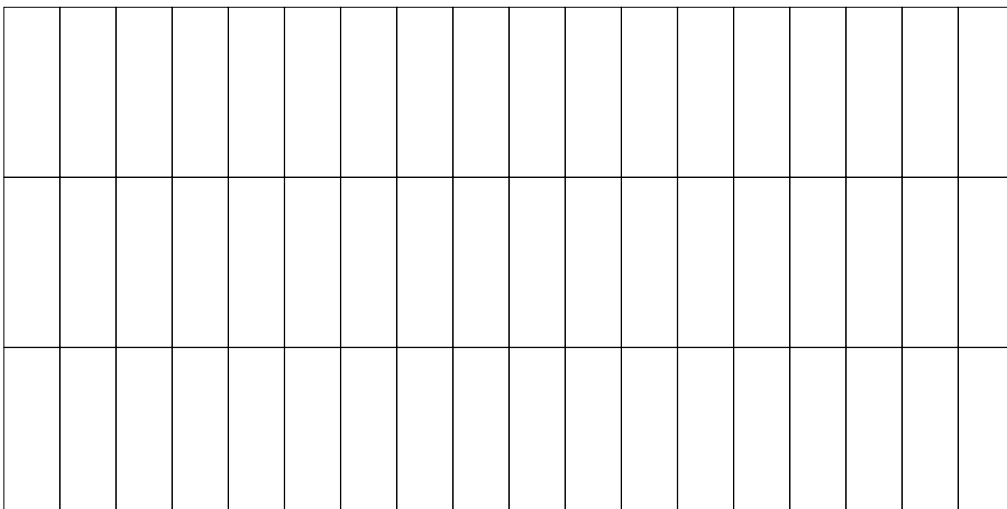
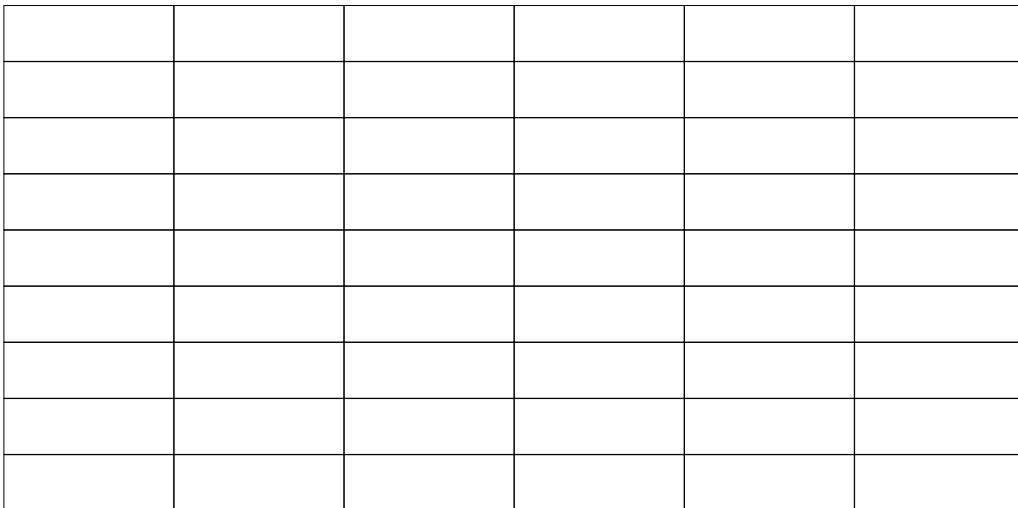
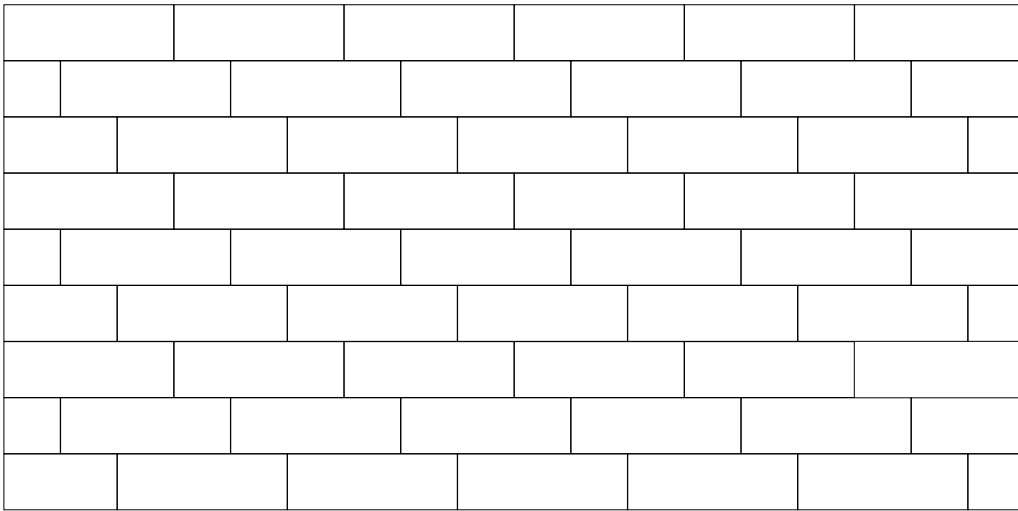

25x70

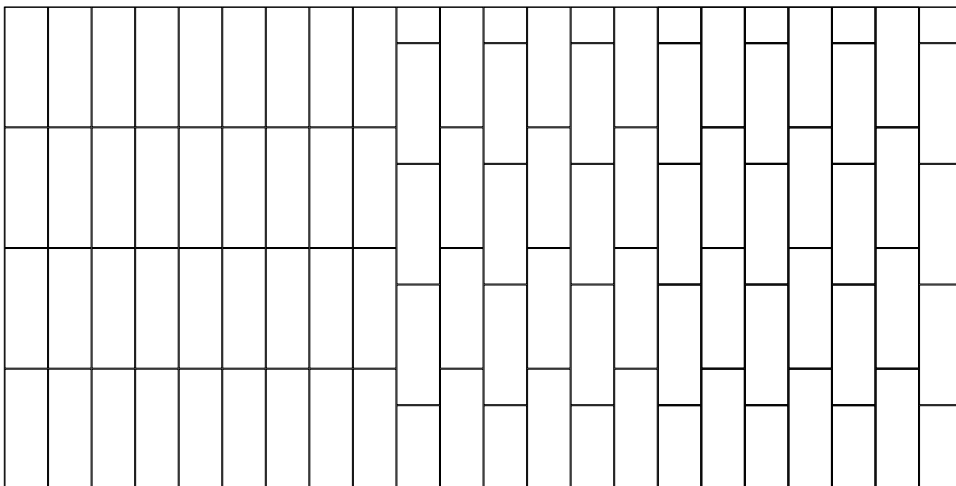
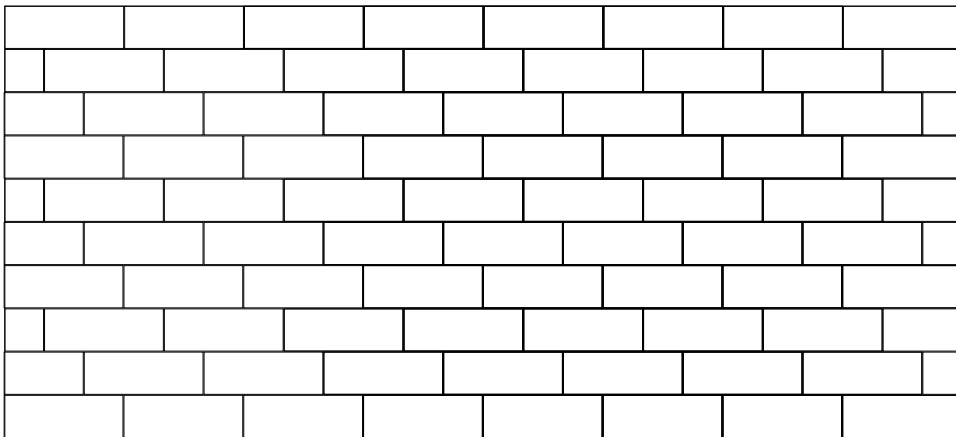
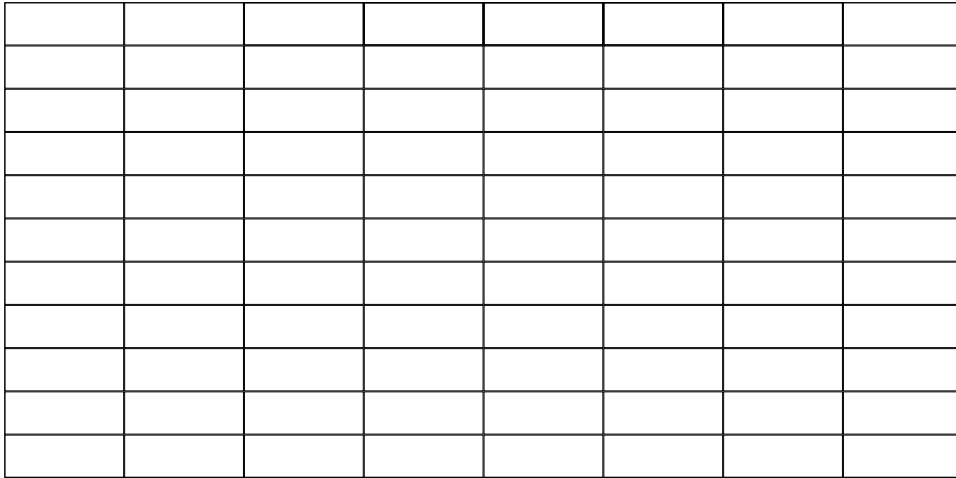

Döşeme Seçenekleri / Tiling Option

40x80

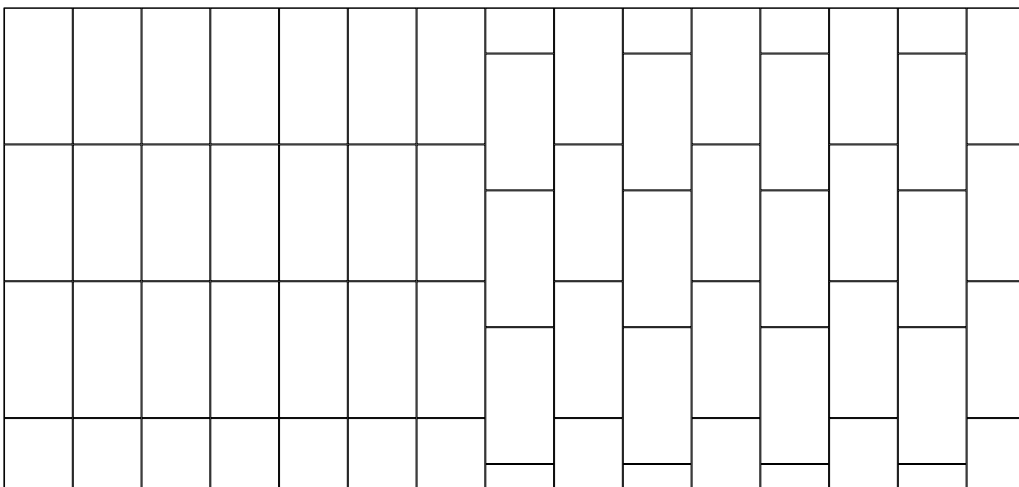
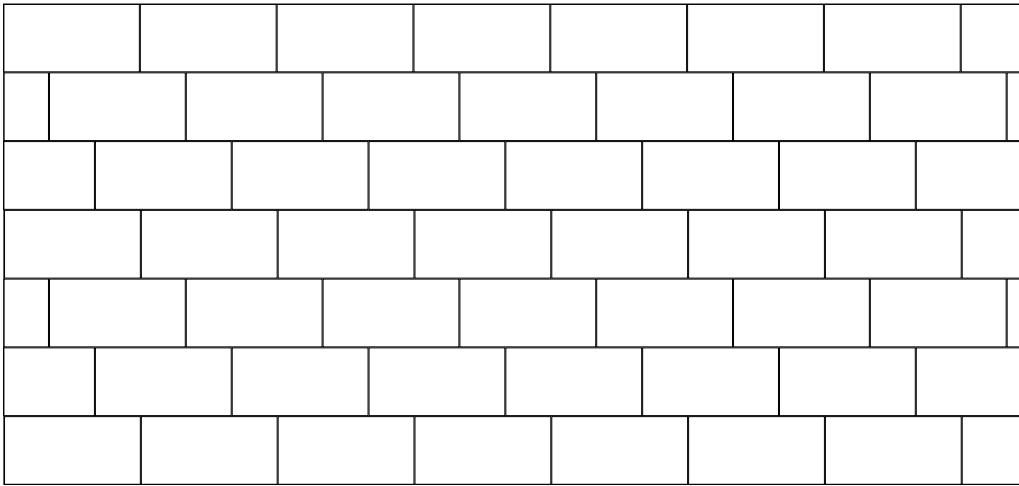
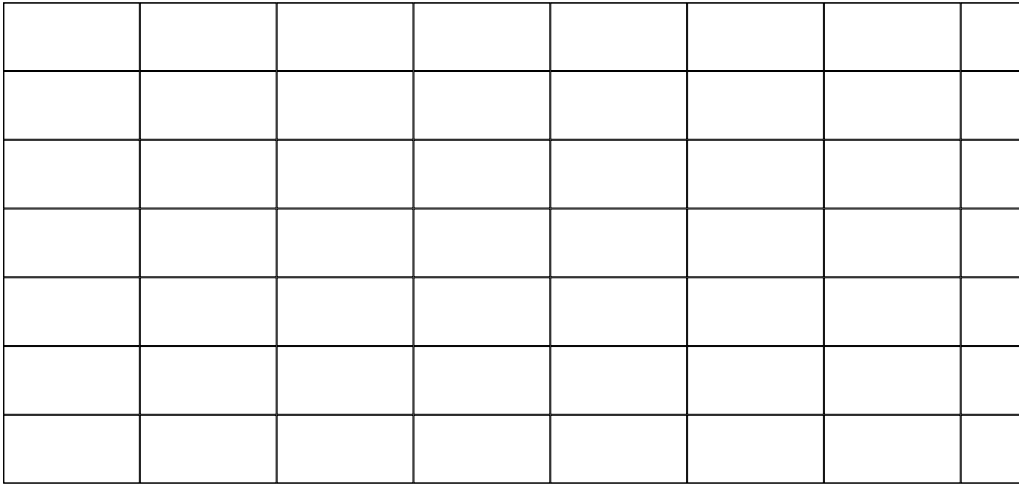

30x60

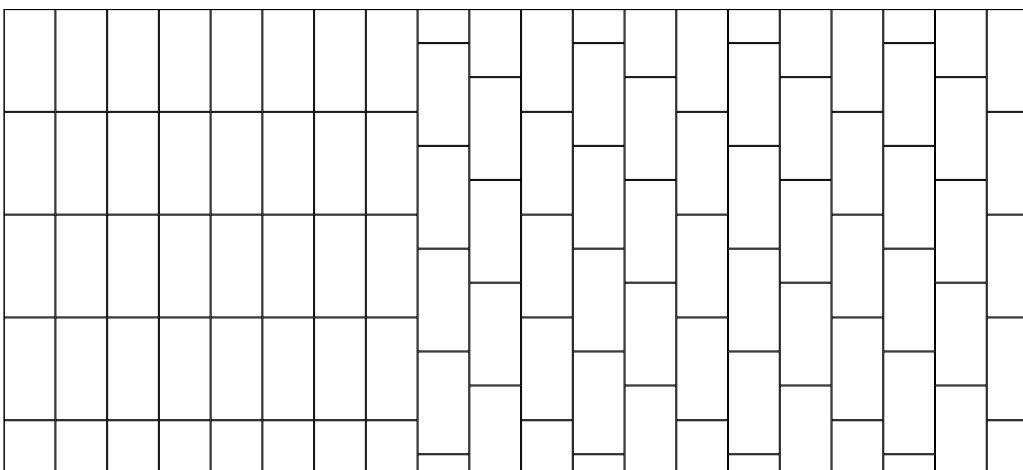
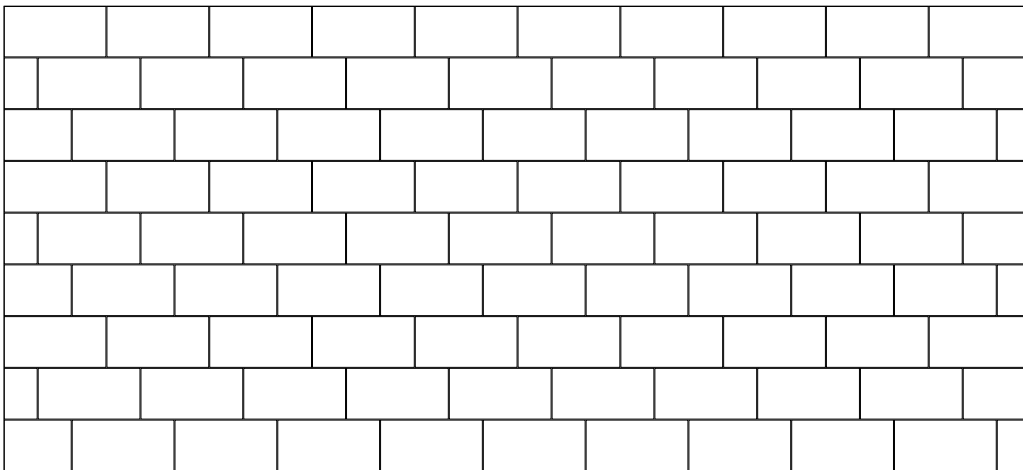
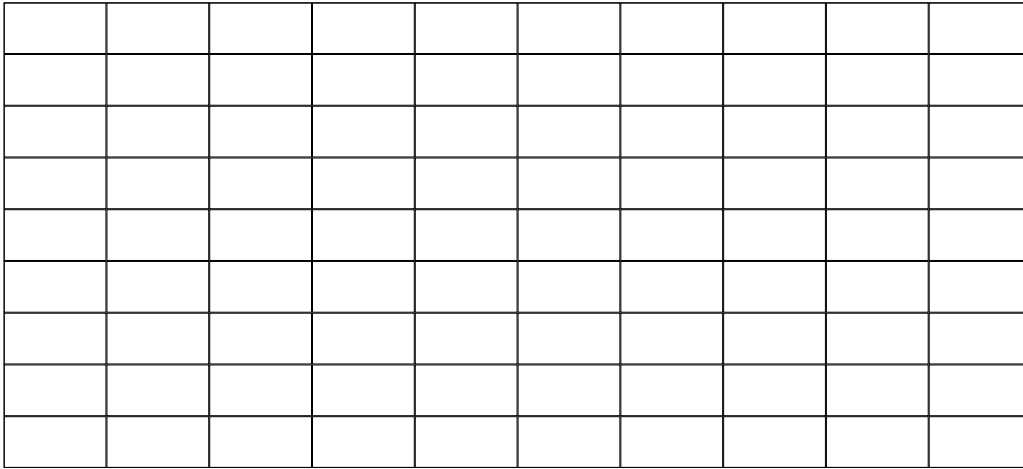

Döşeme Seçenekleri / Tiling Option

80x80

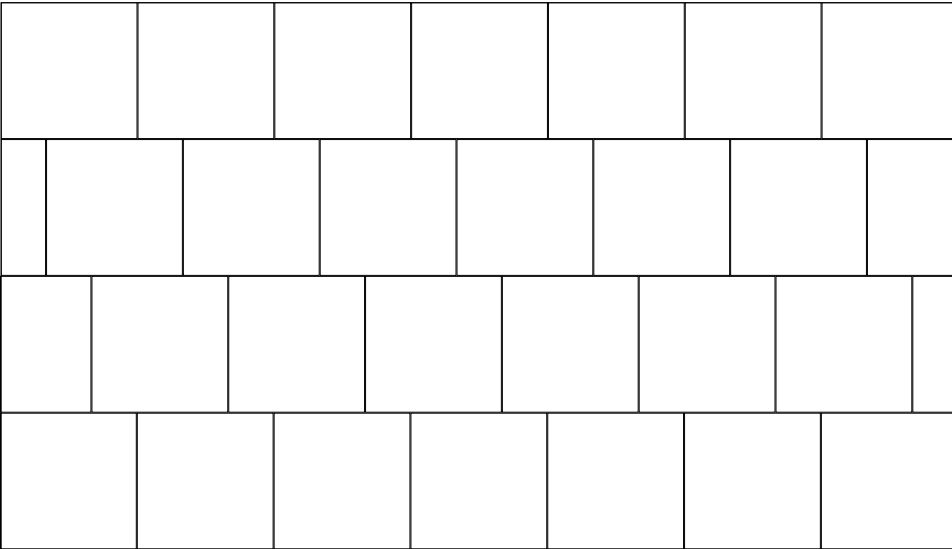
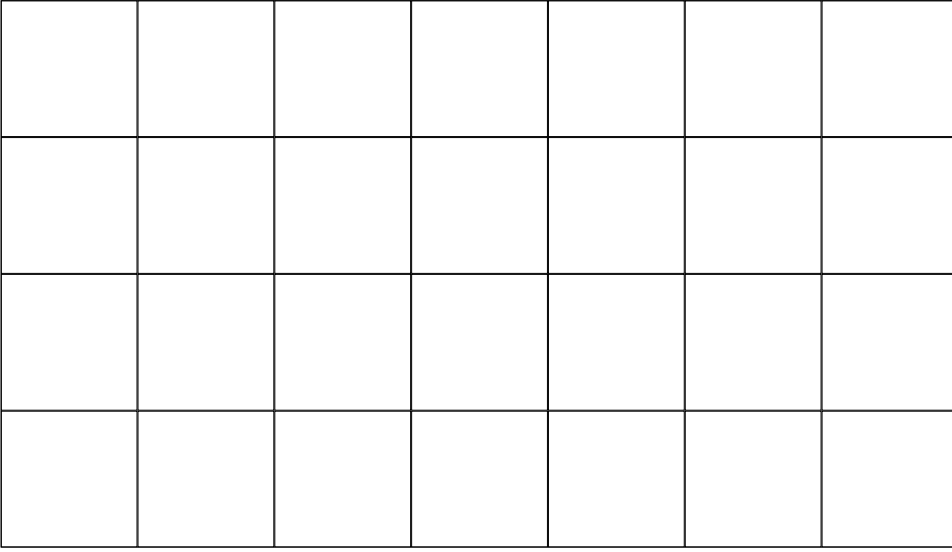

80x80

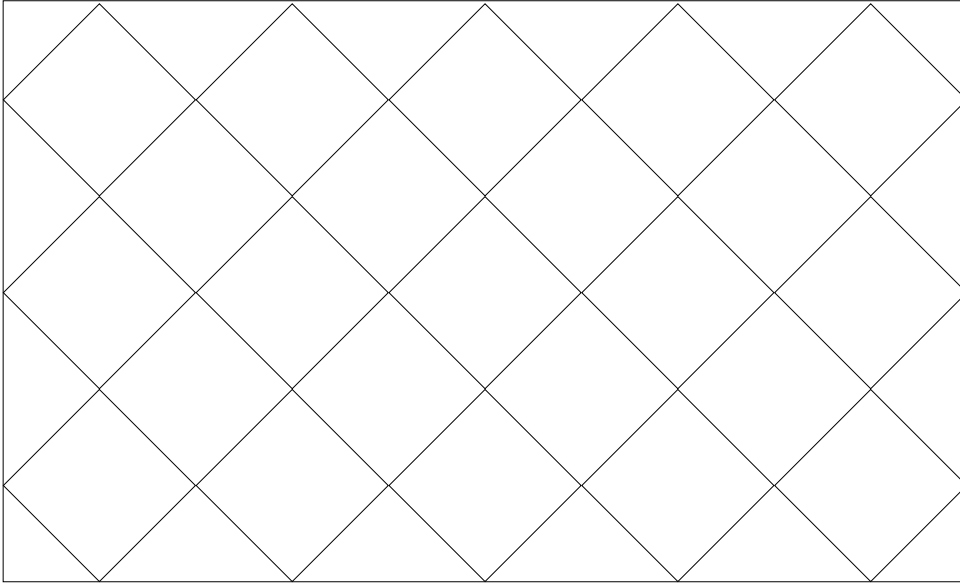

80x80 - 40x80

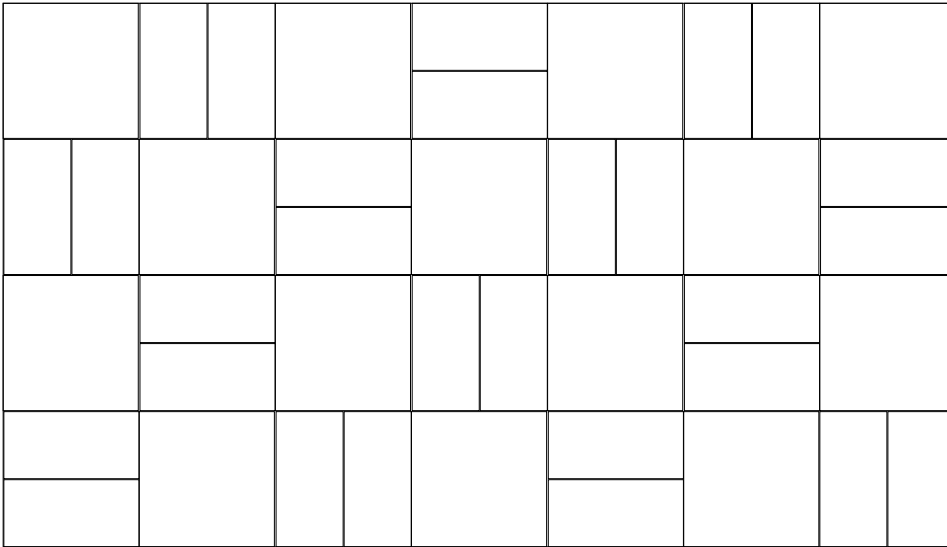

Döşeme Seçenekleri / Tiling Option

80x80 - 40x80 -
10x80

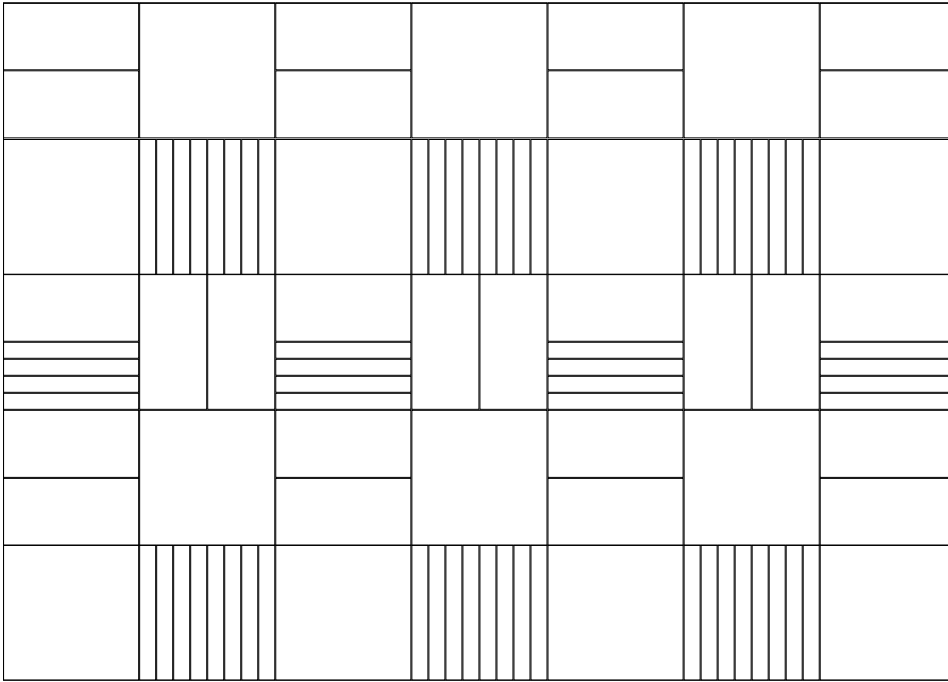

80x80 - 10x80

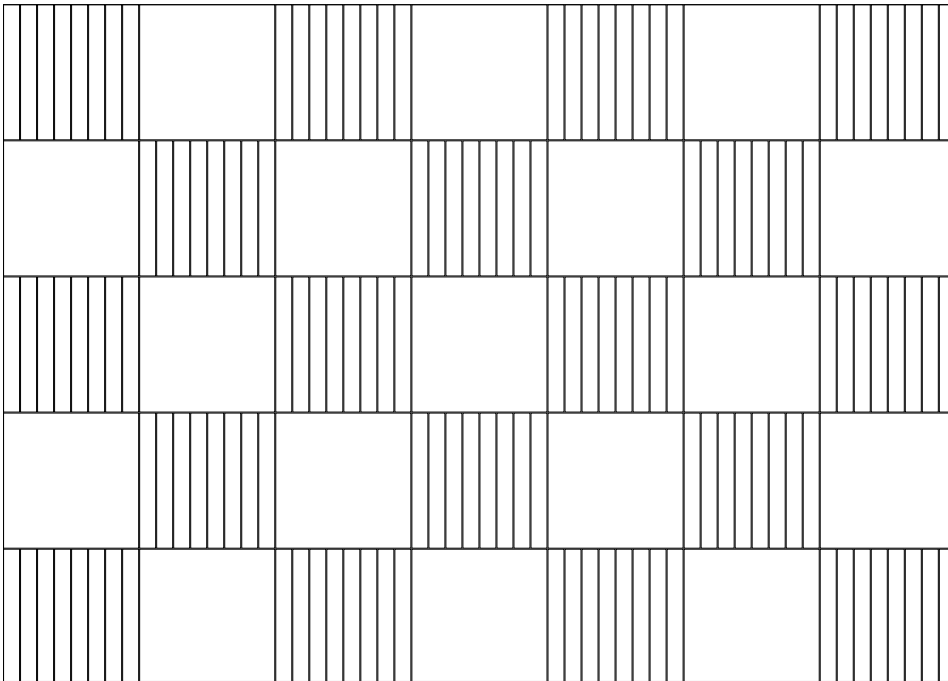

22.5x90

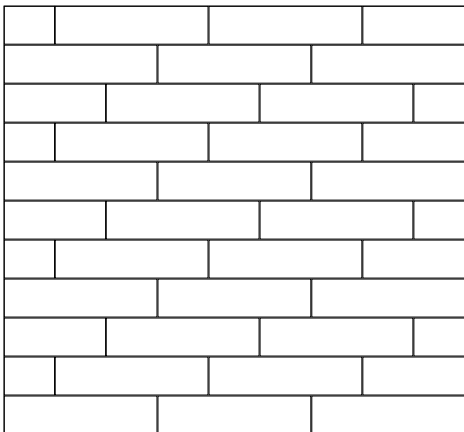
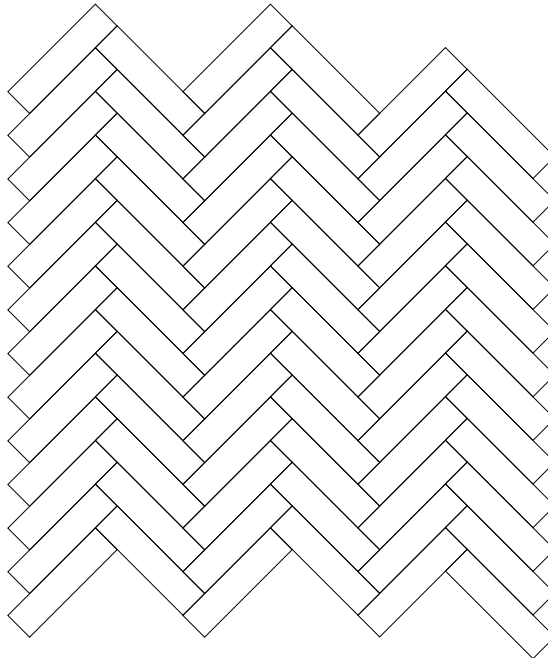
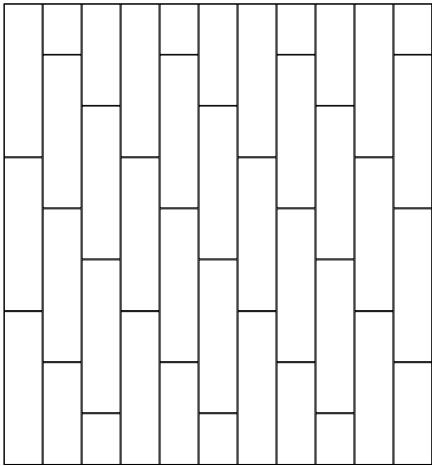
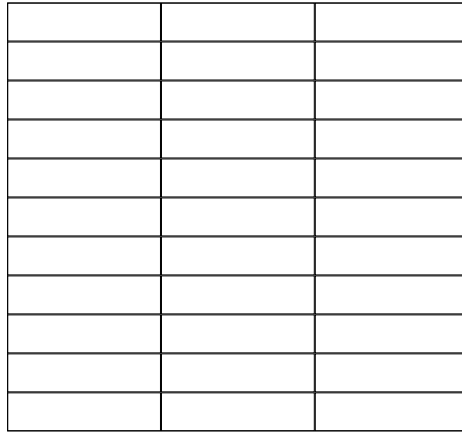
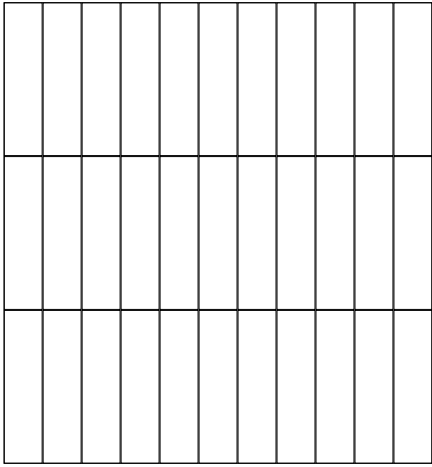

Döşeme Seçenekleri / Tiling Option

20x120

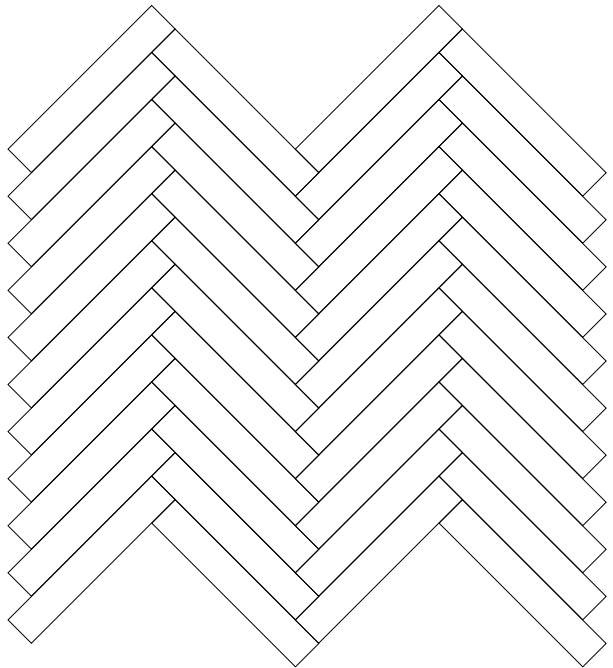
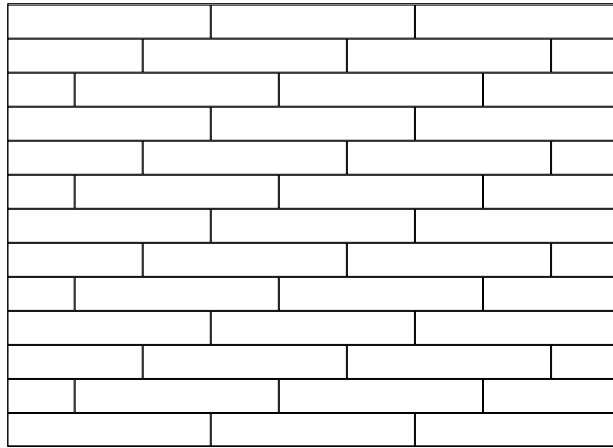
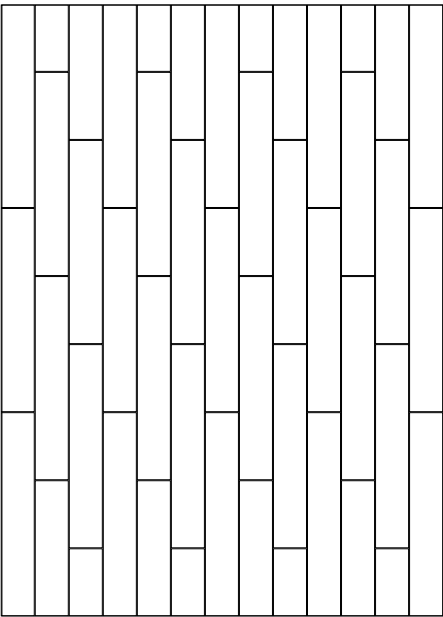
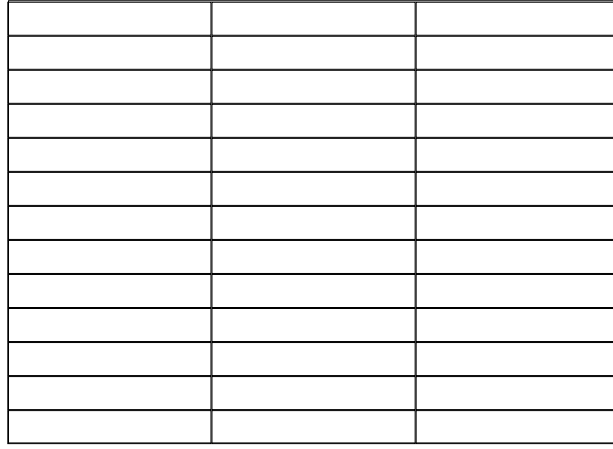
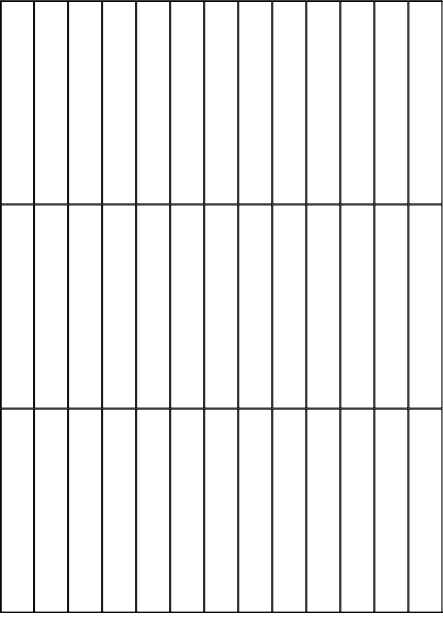

**Laying tiles with maximum 1/4 shifting from the long edge of the rectangular tiles is recommended. Laying tiles with 1/2 shifting from the tiles is not recommended

**Ürünlerde kaydırmalı döşeme yapılacaksa problem yaşanmaması için kaydırmanın karonun uzun kenarının max 1/4'lük kısmından yapılması gerekmektedir. Karonun tam ortasından yapılan döşeme uygulamaları kesinlikle önerilmez.

45x90

60x120

Döşeme Seçenekleri / Tiling Option

60x120

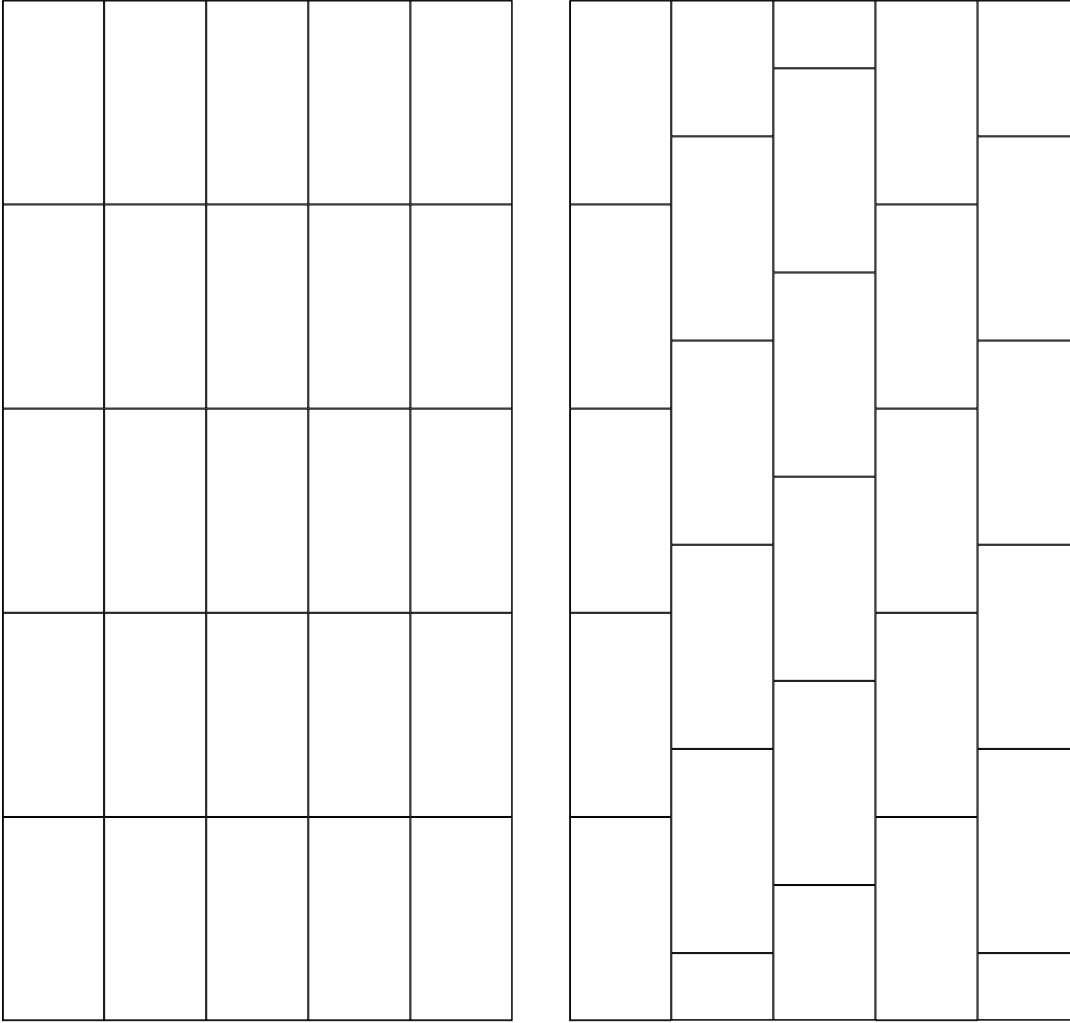

60x120 - 60x60 - 30x60

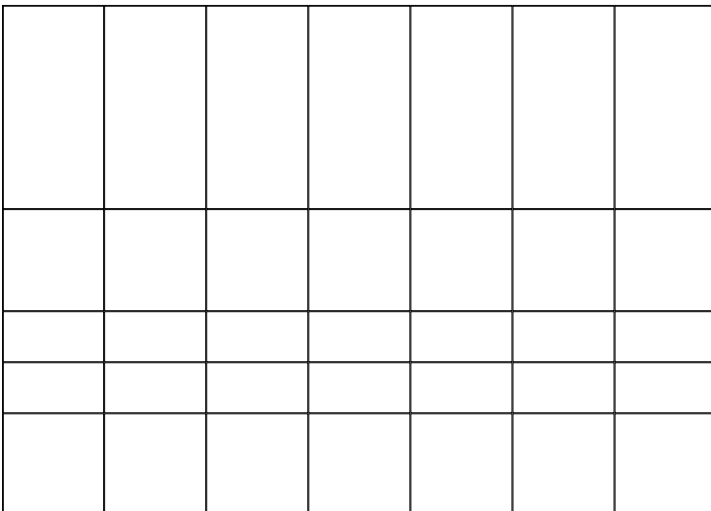

40x80

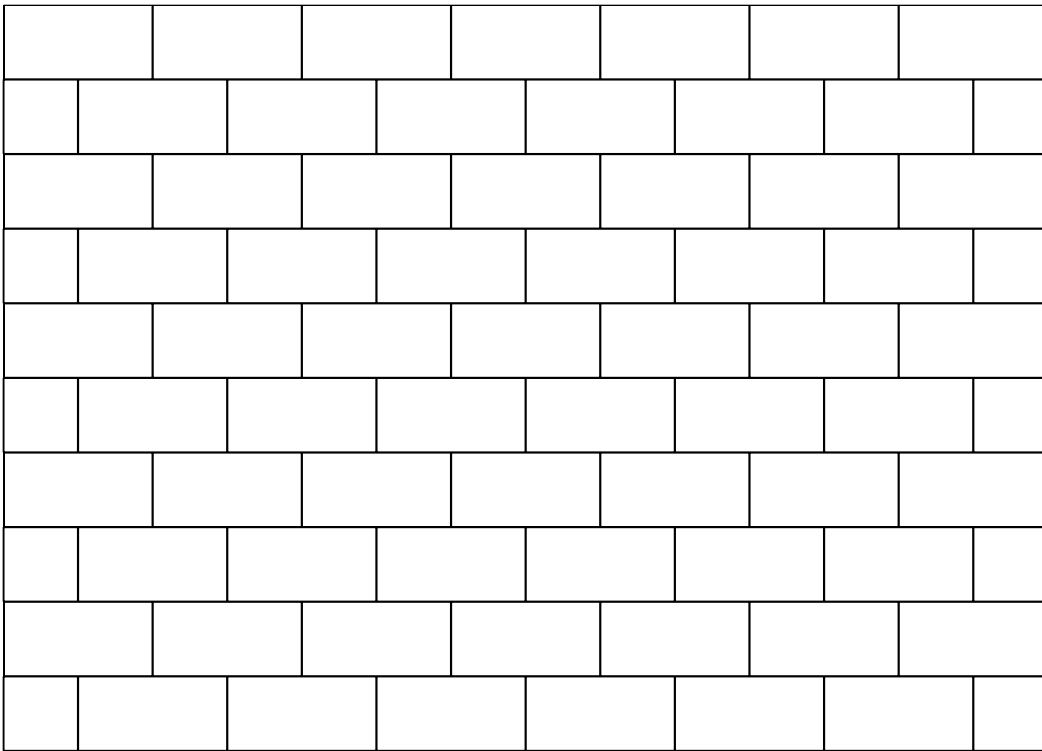
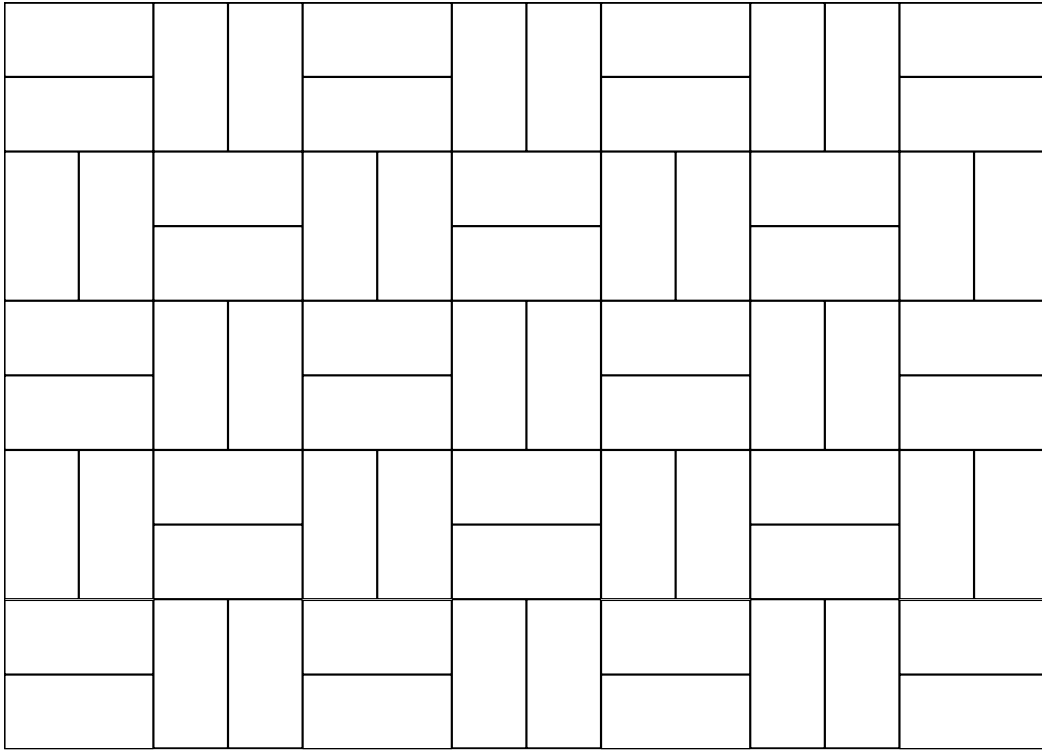

Döşeme Seçenekleri / Tiling Option

20x80 - 40x80

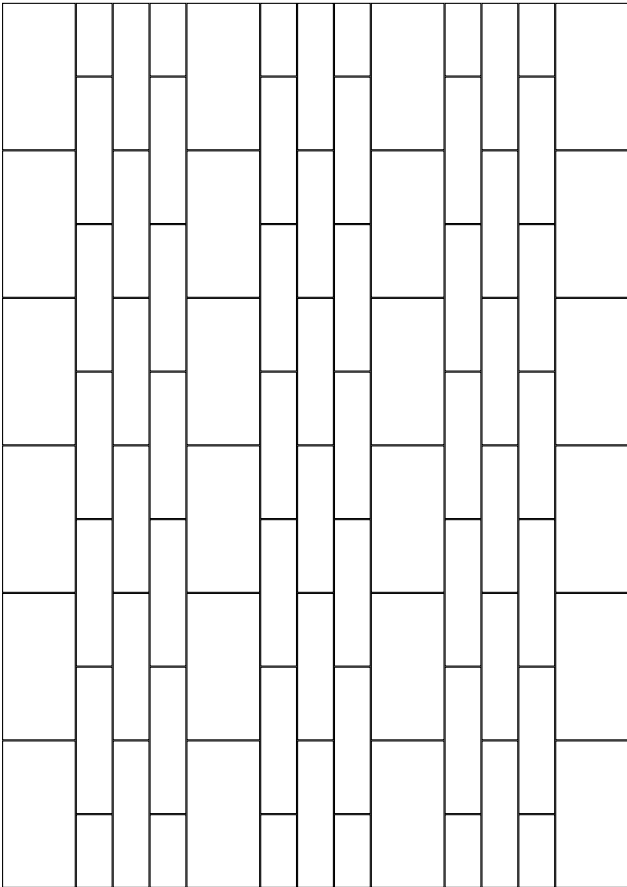
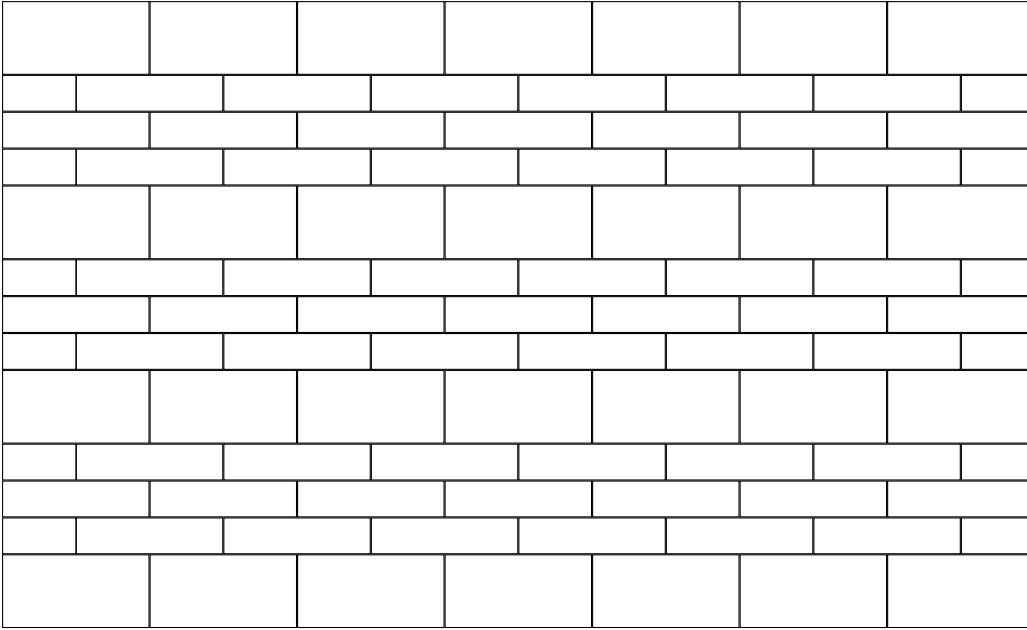

10x30

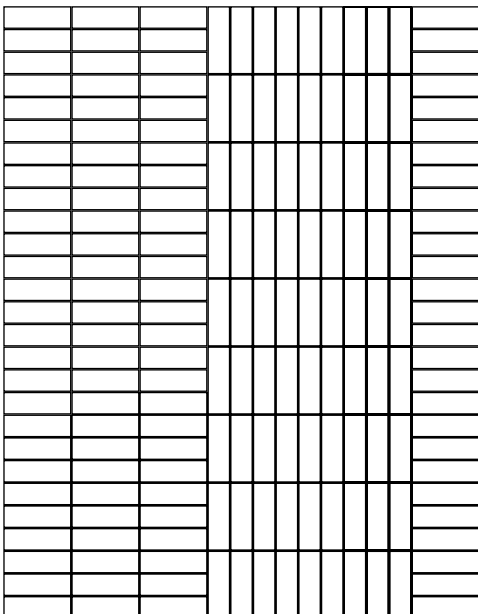
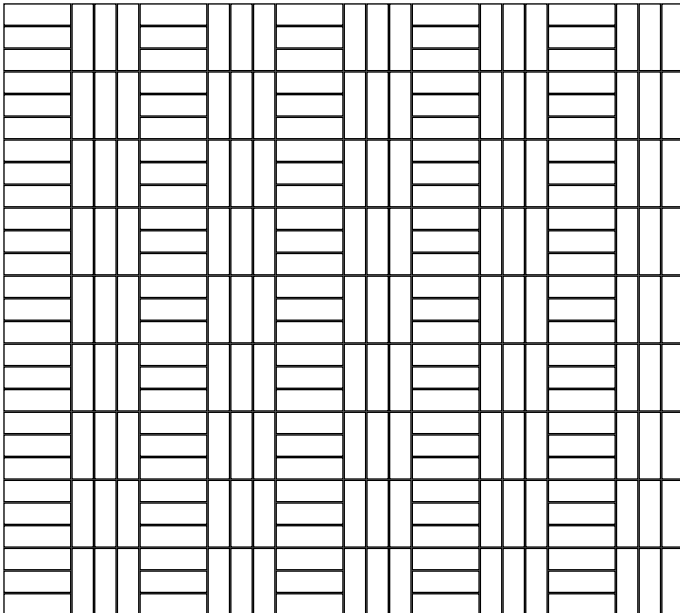
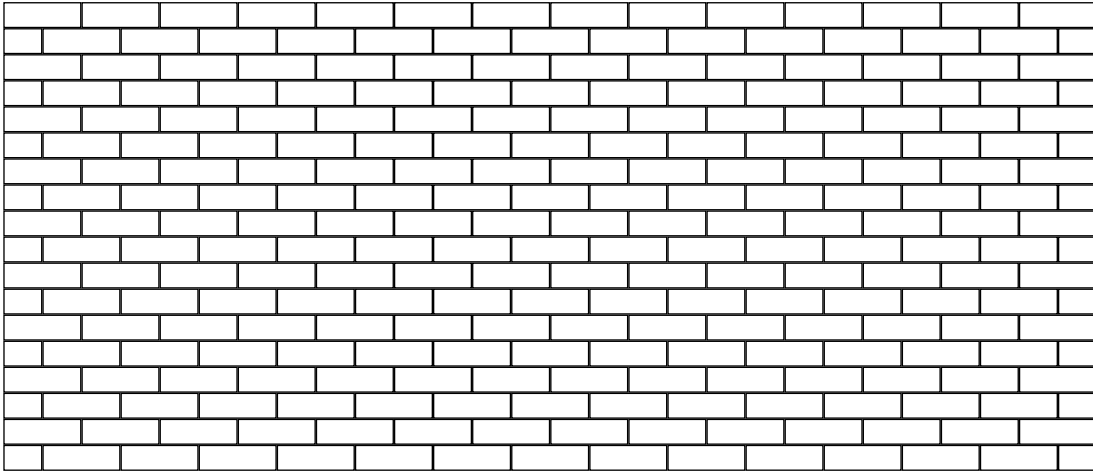

Döşeme Seçenekleri / Tiling Option

10x10 - 10x30

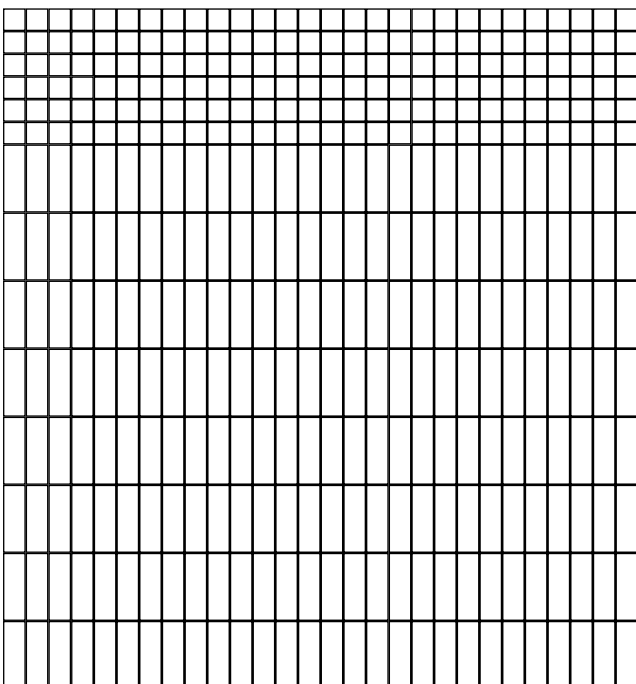
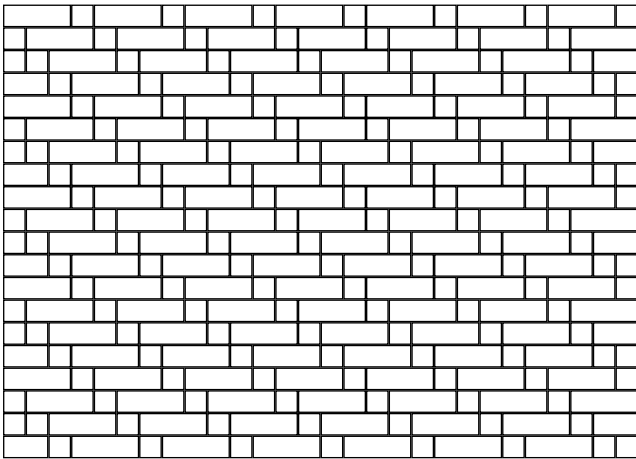
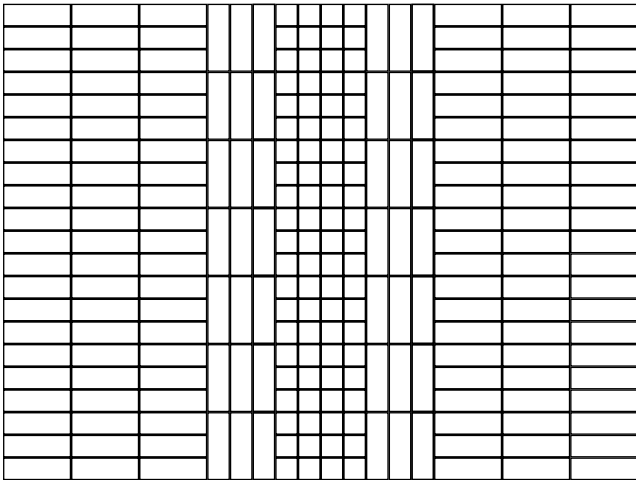

ABD ve Kanada için Teknik Bilgiler Tablosu / Technical Data for US and Canada

Product	Size	Surface	SCOF Wet	SCOF Dry	Water Absorption	Breaking Strength (lbf)	Scratch Hardness Mohs
Ararat	60x60	Matt	≥0,60	≥0,80	≤ 0,5%	> 420	6
Ararat	30x60	Matt	≥0,60	≥0,80	≤ 0,5%	> 420	6
Ararat	60x60	Lappato	≥0,60	≥0,80	≤ 0,5%	> 420	6
Ararat	30x60	Lappato	≥0,60	≥0,80	≤ 0,5%	> 420	6
Ash&Burn	30x60	R9	≥0,60	≥0,80	≤ 0,5%	> 400	8-9
Ash&Burn	60x60	R9	≥0,60	≥0,80	≤ 0,5%	> 400	8-9
Ash&Burn	40x80	R9	≥0,60	≥0,80	≤ 0,5%	> 600	8-9
Ash&Burn	80x80	R9	≥0,60	≥0,80	≤ 0,5%	> 600	8-9
Ash&Burn	10x80	R9	≥0,60	≥0,80	≤ 0,5%	> 250	8-9
Ash&Burn	5x5	R10B	≥0,60	≥0,80	≤ 0,5%	> 250	8-9
Aspenwood	20x120	R10A	≥0,60	≥0,80	≤ 0,5%	> 250	8-9
British Stone	60x60	Lappato	≥0,55	≥0,70	≤ 0,5%	> 420	7-8
British Stone	20x120	Lappato	≥0,55	≥0,70	≤ 0,5%	> 250	7-8
British Stone	20x120	R10A	≥0,60	≥0,80	≤ 0,5%	> 250	7-8
British Stone	30x60	Lappato	≥0,55	≥0,70	≤ 0,5%	> 420	7-8
British Stone	30x60	R10A	≥0,60	≥0,80	≤ 0,5%	> 420	7-8
British Stone	45x90	Lappato	≥0,55	≥0,70	≤ 0,5%	> 600	7-8
British Stone	60x120	Lappato	≥0,55	≥0,70	≤ 0,5%	> 600	7-8
British Stone	60x120	R10A	≥0,60	≥0,80	≤ 0,5%	> 600	7-8
British Stone	60x60	Lappato	≥0,55	≥0,70	≤ 0,5%	> 420	7-8
British Stone	60x60	R10A	≥0,60	≥0,80	≤ 0,5%	> 420	7-8
British Stone	60x60	Lappato	≥0,55	≥0,70	≤ 0,5%	> 420	7-8
Calacatta-Honed Touch	80x80	Honed	≥0,50	≥0,70	≤ 0,5%	> 600	5
Calacatta-dekor	80x80	Matt	≥0,60	≥0,80	≤ 0,5%	> 600	5
Calacatta	60x120	Fulllappato	N/A	N/A	≤ 0,5%	> 600	3-4
Calacatta	20x120	Fulllappato	N/A	N/A	≤ 0,5%	> 250	3-4
Calacatta-Honed	40x80	Honed	≥0,50	≥0,70	≤ 0,5%	> 600	5
Calacatta	60x60	Fulllappato	N/A	N/A	≤ 0,5%	> 420	3-4
Calacatta-Honed	60x60	Honed	≥0,50	≥0,70	≤ 0,5%	> 420	5
Cement Tech	40x80	Lappato	≥0,50	≥0,70	≤ 0,5%	> 600	5
Cement Tech	80x80	R9	≥0,60	≥0,80	≤ 0,5%	> 600	7
Cement Tech	80x80	Lappato	≥0,50	≥0,70	≤ 0,5%	> 600	5
Cement Tech	40x80	R9	≥0,60	≥0,80	≤ 0,5%	> 600	7
Cement Tech	60x60	R9	≥0,60	≥0,80	≤ 0,5%	> 420	7
Clay-Cement	30x60	R9	≥0,50	≥0,70	≤ 0,5%	> 400	8-9
Clay-Cement	60x60	R9	≥0,50	≥0,70	≤ 0,5%	> 400	8-9
Clay-Cement	5x5	R9	≥0,50	≥0,70	≤ 0,5%	> 400	8-9
Clay-Cement *Cut Decors	30x60*	R9	≥0,50	≥0,70	≤ 0,5%	> 400	8-9
Iceandsmoke	60x60	Fulllappato	N/A	N/A	≤ 0,5%	> 420	3-4
Iceandsmoke	80x80	R9	≥0,60	≥0,80	≤ 0,5%	> 600	7
Iceandsmoke	40x80	R9	≥0,60	≥0,80	≤ 0,5%	> 600	7
Iceandsmoke	60x60	R9	≥0,60	≥0,80	≤ 0,5%	> 420	7
Iceandsmoke	10x80	R9	≥0,60	≥0,80	≤ 0,5%	> 250	7
Marfim	60x120	Fulllappato	N/A	N/A	≤ 0,5%	> 600	3-4
Marfim-Honed	80x80	Honed	≥0,50	≥0,70	≤ 0,5%	> 600	5
Marfim	60x60	Fulllappato	N/A	N/A	≤ 0,5%	> 420	3-4
Matrix <small>Geometric 1</small>	60X60	R11B	≥0,60	≥0,80	≤ 0,5%	> 420	7

ABD ve Kanada için Teknik Bilgiler Tablosu / Technical Data for US and Canada

Product	size	Surface	SCOF Wet	SCOF Dry	Water Absorption	Breaking Strength (lbf)	Scratch Hardness Mohs
Matrix Geometric 2	60X60	R10B	≥0,60	≥0,80	≤ 0,5%	> 420	7
Matrix Plain	60X60	R10A	≥0,60	≥0,80	≤ 0,5%	> 420	7
Matrix Random 1	60X60	R11C	≥0,60	≥0,80	≤ 0,5%	> 420	7
Matrix Random 2	60X60	R11B	≥0,60	≥0,80	≤ 0,5%	> 420	7
Matrix Geometric 1	30x60	R11B	≥0,60	≥0,80	≤ 0,5%	> 420	7
Matrix Geometric 2	30x60	R10B	≥0,60	≥0,80	≤ 0,5%	> 420	7
Matrix Plain	30x60	R10A	≥0,60	≥0,80	≤ 0,5%	> 420	7
Matrix Random 1	30x60	R11C	≥0,60	≥0,80	≤ 0,5%	> 420	7
Matrix Random 2	30x60	R11B	≥0,60	≥0,80	≤ 0,5%	> 420	7
Matrix Flake	30X30	R10A	≥0,60	≥0,80	≤ 0,5%	> 250	7-8
Matrix Flake	30X30	R10A	≥0,60	≥0,80	≤ 0,5%	> 250	7-8
Matrix Flake	30X30	R10A	≥0,60	≥0,80	≤ 0,5%	> 250	7-8
Meridien	30x60	R10A	≥0,60	≥0,80	≤ 0,5%	> 420	7-8
Meridien	60x60	R10A	≥0,60	≥0,80	≤ 0,5%	> 420	7-8
Microtec	60x60	Matt	≥0,60	≥0,80	≤ 0,1%	> 420	6-7
Microtec	30x60	Matt	≥0,60	≥0,80	≤ 0,1%	> 600	6-7
Newcon	60x120	R10A	≥0,60	≥0,80	≤ 0,5%	> 600	8-9
Newcon	60x120	LPR	-	-	≤ 0,5%	> 600	7-8
Newcon	80x80	R10A	≥0,60	≥0,80	≤ 0,5%	> 600	8-9
Newcon	80x80	LPR	-	-	≤ 0,5%	> 600	7-8
Newcon	60X60	R10A	≥0,60	≥0,80	≤ 0,5%	> 400	8-9
Newcon	60X60	R11B	≥0,60	≥0,80	≤ 0,5%	> 400	8-9
Newcon	60X60	R9 LPR	-	-	≤ 0,5%	> 400	7-8
Newcon	30x60	R10A	≥0,60	≥0,80	≤ 0,5%	> 400	8-9
Newcon	30x60	R11B	≥0,60	≥0,80	≤ 0,5%	> 400	8-9
Newcon	30x60	R9 LPR	-	-	≤ 0,5%	> 400	7-8
Newcon	45X45	Matt	-	-	≤ 0,5%	> 400	5-6
Newcon	5X5	R10B	≥0,60	≥0,80	≤ 0,5%	> 250	8-9
Newcon	5X5	R9 LPR	-	-	≤ 0,5%	> 250	7-8
Newcon	30x30	R10A	≥0,60	≥0,80	≤ 0,5%	> 250	8-9
Newcon *Cut Borders	30x60*	R10B	≥0,60	≥0,80	≤ 0,5%	> 250	8-9
Pera	20x120	R9	≥0,60	≥0,80	≤ 0,5%	> 250	9
Piccadily	45x90	R9	≥0,60	≥0,80	≤ 0,5%	> 600	8
Piccadily	60x60	R9	≥0,60	≥0,80	≤ 0,5%	> 420	8
Piccadily	30x60	R9	≥0,60	≥0,80	≤ 0,5%	> 420	8
Pulpis	60x60	Fullappato	N/A	N/A	≤ 0,5%	> 420	3-4
Quarzite	30x60	R9	≥0,60	≥0,70	≤ 0,1%	> 420	6-7
Piccadily	45x90	R9	≥0,60	≥0,80	≤ 0,5%	> 600	8
Piccadily	60x60	R9	≥0,60	≥0,80	≤ 0,5%	> 420	8
Piccadily	30x60	R9	≥0,60	≥0,80	≤ 0,5%	> 420	8
Pulpis	60x60	Fullappato	N/A	N/A	≤ 0,5%	> 420	3-4
Quarzite	30x60	R9	≥0,60	≥0,70	≤ 0,1%	> 420	6-7
Rainforest	60x60	R9	≥0,60	≥0,80	≤ 0,5%	> 420	6
Rainforest	30x60	R9	≥0,60	≥0,80	≤ 0,5%	> 420	6
Samba	20x120	R10	≥0,60	≥0,80	≤ 0,5%	> 250	9
Stoneway	45x45	R9	≥0,55	≥0,80	≤ 0,5%	> 420	6
Tech-Slate	15x90	R10A	≥0,60	≥0,80	≤ 0,5%	> 250	7-8

Product	size	Surface	SCOF Wet	SCOF Dry	Water Absorbition	Breaking Strength (lbf)	Scratch Hardness Mohs
Tech-Slate	30x60	R10A	≥0,60	≥0,80	≤ 0,5%	> 420	7-8
Tech-Slate	60x60	R10A	≥0,60	≥0,80	≤ 0,5%	> 420	7-8
Tech-Slate	45x90	R10A	≥0,60	≥0,80	≤ 0,5%	> 600	7-8
Tech-Slate	15x90		≥0,50	≥0,70	≤ 0,5%	> 250	7-8
Tech-Slate	60x60 Altigen	R10A	≥0,60	≥0,80	≤ 0,5%	> 420	7-8
Tech-Slate	60x60 Altigen		≥0,50	≥0,70	≤ 0,5%	> 420	7-8
Tech-Slate	60x60 Altigen		≥0,50	≥0,70	≤ 0,5%	> 420	7-8
Tech-Slate	15x90		≥0,50	≥0,70	≤ 0,5%	> 250	7-8
Uptown	45x90	Matt	≥0,60	≥0,80	≤ 0,5%	> 600	6
Uptown	22,5x90	Matt	≥0,60	≥0,80	≤ 0,5%	> 420	6
Uptown	15x90	Matt	≥0,60	≥0,80	≤ 0,5%	> 250	6
Uptown	60x60	Matt	≥0,60	≥0,80	≤ 0,5%	> 420	6
Uptown	30x60	Matt	≥0,60	≥0,80	≤ 0,5%	> 420	6
Urban Blue	80x80	R9	≥0,55	≥0,70	≤ 0,5%	> 600	8-9
Urban Blue	80x80	Antik/Antique	≥0,60	≥0,80	≤ 0,5%	> 600	8-9
Urban Blue	40x80	Antik/Antique	≥0,55	≥0,70	≤ 0,5%	> 600	8-9
Urban Blue	10x80	Antik/Antique	≥0,55	≥0,70	≤ 0,5%	> 250	8-9
Urban Blue	5x5	Antik/Antique R10B	≥0,55	≥0,70	≤ 0,5%	> 250	8-9
Urban Quarzite	60x60	R11	≥0,60	≥0,80	≤ 0,5%	> 600	7
Urban Quarzite	60x120	R10A	≥0,60	≥0,80	≤ 0,5%	> 600	7
Urban Quarzite	60x60	R10A	≥0,60	≥0,80	≤ 0,5%	> 420	7
Vado	60x60	Matt	≥0,60	≥0,80	≤ 0,5%	> 420	7
Vado	45x45	R10B	≥0,60	≥0,80	≤ 0,5%	> 420	7
Vado	30x60	Matt	≥0,60	≥0,80	≤ 0,5%	> 420	7
Vado	30x30	Matt	≥0,60	≥0,80	≤ 0,5%	> 250	7
Versus	80x80	R9	≥0,60	≥0,80	≤ 0,5%	> 600	6
Versus-Honed Touch	80x80	Honed	≥0,50	≥0,70	≤ 0,5%	> 600	5
Versus	60x60	Fulllappato	N/A	N/A	≤ 0,5%	> 420	3-4
Woodplus	15x90	R10	≥0,60	≥0,80	≤ 0,5%	> 420	8
Woodplus		R10	≥0,60	≥0,80	≤ 0,5%	> 420	8
Woodmix	20x120	R10	≥0,60	≥0,80	≤ 0,5%	> 250	8
Woodmix	30x120	R10	≥0,60	≥0,80	≤ 0,5%	> 250	7-8

Test Sonuçları / Test Results

URBANCRETE

Ebatlar / Sizes	Kutu İçi Adet / Units in Box	Kutu İçi m ² / Box m ²	Kutu İçi kg / Box kg	Palet İçi Adet / Units in Pallet	Palet m ² / Pallet m ²	Palet kg / Pallet kg
80x80 Rectified	2	1,28	27,5	80	51,2	1100
40x80 Rectified	4	1,28	26	25	32	650
60x120 Rectified	3	2,16	46,5	60	43,2	930
60x60 Rectified	4	1,44	26,5	120	43,2	807
30x60 Rectified	6	1,08	20,3	240	43,2	820
21x24 Non-Rectified	17	0,68	12,58	1292	51,68	960
5x5 Mosaic	396	0,63	9,8	588	52,92	805

Su Emme /
Water Absorption

Koleksiyon / Collection	Bünye Tipi / Body Type	Rektifiyeli - Rektifiyesiz / Rectified-Non-rectified	Yüzey / Surface	Ebat / Size	EN ISO 10545-3	EN ISO 10545-4
URBANCRETE	Bla	Rectified	R10A	80x80	Avg. Ev ≤ 0,5 %	> 1300 N
URBANCRETE	Bla	Rectified	R9 LPR	80X80	Avg. Ev ≤ 0,5 %	> 1300 N
URBANCRETE	Bla	Rectified	R10A	40X80	Avg. Ev ≤ 0,5 %	> 1300 N
URBANCRETE	Bla	Rectified	R9 LPR	40X80	Avg. Ev ≤ 0,5 %	> 1300 N
URBANCRETE	Bla	Rectified	R10A	60x60	Avg. Ev ≤ 0,5 %	> 1300 N
URBANCRETE	Bla	Rectified	R9 LPR	60x60	Avg. Ev ≤ 0,5 %	> 1300 N
URBANCRETE	Bla	Rectified	R10A	30x60	Avg. Ev ≤ 0,5 %	> 1300 N
URBANCRETE	Bla	Rectified	R9 LPR	30x60	Avg. Ev ≤ 0,5 %	> 1300 N
URBANCRETE	Bla	Rectified	MATT	21X24	Avg. Ev ≤ 0,5 %	> 1300 N

CEPPOSTONE

Ebatlar / Sizes	Kutu İçi Adet / Units in Box	Kutu İçi m ² / Box m ²	Kutu İçi kg / Box kg	Palet İçi Adet / Units in Pallet	Palet m ² / Pallet m ²	Palet kg / Pallet kg
80x80 Rectified	2	1,28	27,5	80	51,2	1100
40x80 Rectified	4	1,28	26	25	32	650
60x120 Rectified	3	2,16	46,5	60	43,2	930
60x60 Rectified	4	1,44	26,5	120	43,2	807
30x60 Rectified	6	1,08	20,3	240	43,2	820
21x24 Non-Rectified	17	0,68	12,58	1292	51,68	960

Su Emme /
Water Absorption

Koleksiyon / Collection	Bünye Tipi / Body Type	Rektifiyeli - Rektifiyesiz / Rectified-Non-rectified	Yüzey / Surface	Ebat / Size	EN ISO 10545-3	EN ISO 10545-4
CEPPOSTONE	Bla	Rectified	R9	80x80	Avg. Ev ≤ 0,5 %	> 1300 N
CEPPOSTONE	Bla	Rectified	R9	40x80	Avg. Ev ≤ 0,5 %	> 1300 N
CEPPOSTONE	Bla	Rectified	R9	60X60	Avg. Ev ≤ 0,5 %	> 1300 N

Kırılma Dayanımı / Breaking Strength	Eğilme Dayanımı / Bending Strength	Derin Aşınma Dayanımı / Resistance to Deep Abrasion	MOHs	Pendulum Kuru TRL (55) / Pendulum Dry TRL (55)	Pendulum Islak TRL (55) / Pendulum Wet TRL (55)	Pendulum Kuru 4S (96) / Pendulum Dry 4S (96)	Pendulum Islak 4S (96) / Pendulum Wet 4S (96)
EN ISO 10545-4	EN ISO 10545-6	MOHs	BS 7976-2	BS 7976-2	BS 7976-2	BS 7976-2	ANSI A137.1 Section 9.6.1
Min. 35 N/mm ²	max. 175 mm ³	9	PTVdry ≥ 36	PTVwets24	PTVdry ≥ 36	25 ≤ PTVwet < 36	≥ 0.42
Min. 35 N/mm ²	max. 175 mm ³	8	PTVdry ≥ 36	PTVwets24	PTVdry ≥ 36	PTVwets24	< 0.42
Min. 35 N/mm ²	max. 175 mm ³	9	PTVdry ≥ 36	PTVwets24	PTVdry ≥ 36	25 ≤ PTVwet < 36	≥ 0.42
Min. 35 N/mm ²	max. 175 mm ³	8	PTVdry ≥ 36	PTVwets24	PTVdry ≥ 36	PTVwets24	< 0.42
Min. 35 N/mm ²	max. 175 mm ³	9	PTVdry ≥ 36	25 ≤ PTVwet < 36	PTVdry ≥ 36	25 ≤ PTVwet < 36	≥ 0.42
Min. 35 N/mm ²	max. 175 mm ³	8	PTVdry ≥ 36	PTVwets24	PTVdry ≥ 36	PTVwets24	< 0.42
Min. 35 N/mm ²	max. 175 mm ³	9	PTVdry ≥ 36	25 ≤ PTVwet < 36	PTVdry ≥ 36	25 ≤ PTVwet < 36	≥ 0.42
Min. 35 N/mm ²	max. 175 mm ³	8	PTVdry ≥ 36	PTVwets24	PTVdry ≥ 36	PTVwets24	< 0.42
Min. 35 N/mm ²	Not Applicable	9	PTVdry ≥ 36	PTVwets24	PTVdry ≥ 36	25 ≤ PTVwet < 36	≥ 0.42

Kırılma Dayanımı / Breaking Strength	Eğilme Dayanımı / Bending Strength	Derin Aşınma Dayanımı / Resistance to Deep Abrasion	MOHs	Pendulum Kuru TRL (55) / Pendulum Dry TRL (55)	Pendulum Islak TRL (55) / Pendulum Wet TRL (55)	Pendulum Kuru 4S (96) / Pendulum Dry 4S (96)	Pendulum Islak 4S (96) / Pendulum Wet 4S (96)
EN ISO 10545-4	EN ISO 10545-6	MOHs	BS 7976-2	BS 7976-2	BS 7976-2	BS 7976-2	ANSI A137.1 Section 9.6.1
Min. 35 N/mm ²	max. 175 mm ³	9	PTVdry ≥ 36	PTVwets24	PTVdry ≥ 36	25 ≤ PTVwet < 36	≥ 0.42
Min. 35 N/mm ²	max. 175 mm ³	9	PTVdry ≥ 36	PTVwets24	PTVdry ≥ 36	25 ≤ PTVwet < 36	≥ 0.42
Min. 35 N/mm ²	max. 175 mm ³	9	PTVdry ≥ 36	PTVwets24	PTVdry ≥ 36	PTVwets24	≥ 0.42

Test Sonuçları / Test Results

CARDOSTONE

Ebatlar / Sizes	Kutu İçi Adet / Units in Box	Kutu İçi m ² / Box m ²	Kutu İçi kg / Box kg	Palet İçi Adet / Units in Pallet	Palet m ² / Pallet m ²	Palet kg / Pallet kg
80x80 Rectified	2	1,28	27,5	80	51,2	1100
40x80 Rectified	4	1,28	26	25	32	650
60x120 Rectified	3	2,16	46,5	60	43,2	930
60x60 Rectified	4	1,44	26,5	120	43,2	807
60x60, 20mm	1	0,36	15,37	50	18	770
21x24 Non-Rectified	17	0,68	12,58	1292	51,68	960
30x60, Cut Border	6	1,08	20,3	240	43,2	820
5x5 Mosaic	396	0,63	9,8	588	52,92	805

Su Emme /
Water Absorption

Koleksiyon / Collection	Bünye Tipi / Body Type	Rektifiyeli - Rektifiyesiz / Rectified-Non-rectified	Yüzey / Surface	Ebat / Size	EN ISO 10545-3	EN ISO 10545-4
CARDOSTONE	Bla	Rectified	R10A	40X80	Avg. Ev ≤ 0,5 %	> 1300 N
CARDOSTONE	Bla	Rectified	R10A	80x80	Avg. Ev ≤ 0,5 %	> 1300 N
CARDOSTONE	Bla	Rectified	R10A	60x60	Avg. Ev ≤ 0,5 %	> 1300 N
CARDOSTONE	Bla	Rectified	R10A	60X120	Avg. Ev ≤ 0,5 %	> 1300 N
CARDOSTONE	Bla	Non-Rec	Matt	21X24	Avg. Ev ≤ 0,5 %	> 1300 N

STONELEVEL

Ebatlar / Sizes	Kutu İçi Adet / Units in Box	Kutu İçi m ² / Box m ²	Kutu İçi kg / Box kg	Palet İçi Adet / Units in Pallet	Palet m ² / Pallet m ²	Palet kg / Pallet kg
80x80 Rectified	2	1,28	27,5	80	51,2	1100
40x80 Rectified	4	1,28	26	25	32	650
60x60 Rectified	4	1,44	26,5	120	43,2	807
30x60 Rectified	6	1,08	20,3	240	43,2	820
5x30, Cut Border	56	0,84	18,06	196	23,52	425
5x5 Mosaic	396	0,63	9,8	588	52,92	805

Su Emme /
Water Absorption

Koleksiyon / Collection	Bünye Tipi / Body Type	Rektifiyeli - Rektifiyesiz / Rectified-Non-rectified	Yüzey / Surface	Ebat / Size	EN ISO 10545-3	EN ISO 10545-4
STONELEVEL	Bla	Rectified	R10A	80x80	Avg. Ev ≤ 0,5 %	> 1300 N
STONELEVEL	Bla	Rectified	R9 LPR	80X80	Avg. Ev ≤ 0,5 %	> 1300 N
STONELEVEL	Bla	Rectified	R10A	40X80	Avg. Ev ≤ 0,5 %	> 1300 N
STONELEVEL	Bla	Rectified	R9 LPR	40X80	Avg. Ev ≤ 0,5 %	> 1300 N
STONELEVEL	Bla	Rectified	R10A	60x60	Avg. Ev ≤ 0,5 %	> 1300 N
STONELEVEL	Bla	Rectified	R9 LPR	60x60	Avg. Ev ≤ 0,5 %	> 1300 N
STONELEVEL	Bla	Rectified	R10A	30x60	Avg. Ev ≤ 0,5 %	> 1300 N

Kırılma Dayanımı / Breaking Strength	Eğilme Dayanımı / Bending Strength	Derin Aşınma Dayanımı / Resistance to Deep Abrasion	MOHs	Pendulum Kuru TRL (55) / Pendulum Dry TRL (55)	Pendulum Islak TRL (55) / Pendulum Wet TRL (55)	Pendulum Kuru 4S (96) / Pendulum Dry 4S (96)	Pendulum Islak 4S (96) / Pendulum Wet 4S (96)
EN ISO 10545-4	EN ISO 10545-6	MOHs	BS 7976-2	BS 7976-2	BS 7976-2	BS 7976-2	ANSI A137.1 Section 9.6.1
Min. 35 N/mm ²	max. 175 mm ³	9	PTVdry ≥ 36	25 ≤ PTVdry < 36	PTVdry ≥ 36	25 ≤ PTVdry < 36	≥ 0.42
Min. 35 N/mm ²	max. 175 mm ³	9	PTVdry ≥ 36	25 ≤ PTVwet < 36	PTVdry ≥ 36	25 ≤ PTVwet < 36	≥ 0.42
Min. 35 N/mm ²	max. 175 mm ³	9	PTVdry ≥ 36	25 ≤ PTVwet < 36	PTVdry ≥ 36	25 ≤ PTVwet < 36	≥ 0.42
Min. 35 N/mm ²	max. 175 mm ³	9	PTVdry ≥ 36	25 ≤ PTVwet < 36	PTVdry ≥ 36	25 ≤ PTVwet < 36	≥ 0.42
Min. 35 N/mm ²	Not Applicable	9	PTVdry ≥ 36	25 ≤ PTVwet < 36	PTVdry ≥ 36	25 ≤ PTVwet < 36	≥ 0.42

Kırılma Dayanımı / Breaking Strength	Eğilme Dayanımı / Bending Strength	Derin Aşınma Dayanımı / Resistance to Deep Abrasion	MOHs	Pendulum Kuru TRL (55) / Pendulum Dry TRL (55)	Pendulum Islak TRL (55) / Pendulum Wet TRL (55)	Pendulum Kuru 4S (96) / Pendulum Dry 4S (96)	Pendulum Islak 4S (96) / Pendulum Wet 4S (96)
EN ISO 10545-4	EN ISO 10545-6	MOHs	BS 7976-2	BS 7976-2	BS 7976-2	BS 7976-2	ANSI A137.1 Section 9.6.1
Min. 35 N/mm ²	max. 175 mm ³	9	PTVdry ≥ 36	25 ≤ PTVdry < 36	PTVdry ≥ 36	25 ≤ PTVdry < 36	≥ 0.42
Min. 35 N/mm ²	max. 175 mm ³	9	PTVdry ≥ 36	25 ≤ PTVwet < 36	PTVdry ≥ 36	25 ≤ PTVwet < 36	≥ 0.42
Min. 35 N/mm ²	max. 175 mm ³	9	PTVdry ≥ 36	25 ≤ PTVwet < 36	PTVdry ≥ 36	25 ≤ PTVwet < 36	≥ 0.42
Min. 35 N/mm ²	max. 175 mm ³	9	PTVdry ≥ 36	PTVwets24	PTVdry ≥ 36	25 ≤ PTVwet < 36	≥ 0.42
Min. 35 N/mm ²	max. 175 mm ³	9	PTVdry ≥ 36	PTVwets24	PTVdry ≥ 36	25 ≤ PTVwet < 36	≥ 0.42
Min. 35 N/mm ²	max. 175 mm ³	9	PTVdry ≥ 36	PTVwets24	PTVdry ≥ 36	PTVwets24	≥ 0.42
Min. 35 N/mm ²	max. 175 mm ³	9	PTVdry ≥ 36	PTVwets24	PTVdry ≥ 36	25 ≤ PTVwet < 36	≥ 0.42

Test Sonuçları / Test Results

METALCRETE

Ebatlar / Sizes	Kutu İçi Adet / Units in Box	Kutu İçi m ² / Box m ²	Kutu İçi kg / Box kg	Palet İçi Adet / Units in Pallet	Palet m ² / Pallet m ²	Palet kg / Pallet kg
80x80 Rectified	2	1,28	27,5	80	51,2	1100
40x80 Rectified	4	1,28	26	25	32	650

Su Emme /
Water Absorption

Koleksiyon / Collection	Bünye Tipi / Body Type	Rektifiyeli - Rektifiyesiz / Rectified-Non-rectified	Yüzey / Surface	Ebat / Size	EN ISO 10545-3	EN ISO 10545-4
METALCRETE	Bla	Rectified	R9 LPR	80X80	Avg. Ev ≤ 0,5 %	> 1300 N
METALCRETE	Bla	Rectified	R9 LPR	40X80	Avg. Ev ≤ 0,5 %	> 1300 N

URBANWOOD

Ebatlar / Sizes	Kutu İçi Adet / Units in Box	Kutu İçi m ² / Box m ²	Kutu İçi kg / Box kg	Palet İçi Adet / Units in Pallet	Palet m ² / Pallet m ²	Palet kg / Pallet kg
20x120 Rectified	4	0,96	21,5	124	29,76	640
20x120 Non-Rectified	4	0,96	21,5	192	46,08	1032

Su Emme /
Water Absorption

Koleksiyon / Collection	Bünye Tipi / Body Type	Rektifiyeli - Rektifiyesiz / Rectified-Non-rectified	Yüzey / Surface	Ebat / Size	EN ISO 10545-3	EN ISO 10545-4
URBANWOOD	Bla	Rectified	R10A	20X120	Avg. Ev ≤ 0,5 %	> 1300 N
URBANWOOD	Bla	Non-Rec	R10A	20X120	Avg. Ev ≤ 0,5 %	> 1300 N

SCALE

Ebatlar / Sizes	Kutu İçi Adet / Units in Box	Kutu İçi m ² / Box m ²	Kutu İçi kg / Box kg	Palet İçi Adet / Units in Pallet	Palet m ² / Pallet m ²	Palet kg / Pallet kg
100x300	1	3	25,35	20	60	507

Collection	Rectified/Non-rectified	Surface	Size	EN ISO 10545-3	Su Emme / Water Absorption EN ISO 10545-4	Eğilme Dayanımı / Bending Strength EN ISO 10545-6
SCALE	Rectified	Matt	100x300	Avg. Ev ≤ 0,5 %	Min. 35 N/mm ²	175 mm ³

Kırılma Dayanımı / Breaking Strength	Eğilme Dayanımı / Bending Strength	Derin Aşınma Dayanımı / Resistance to Deep Abrasion	MOHs	Pendulum Kuru TRL (55) / Pendulum Dry TRL (55)	Pendulum Islak TRL (55) / Pendulum Wet TRL (55)	Pendulum Kuru 4S (96) / Pendulum Dry 4S (96)	Pendulum Islak 4S (96) / Pendulum Wet 4S (96)
EN ISO 10545-4	EN ISO 10545-6	MOHs	BS 7976-2	BS 7976-2	BS 7976-2	BS 7976-2	ANSI A137.1 Section 9.6.1
Min. 35 N/mm ²	max. 175 mm ³	8	PTVdry ≥ 36	PTVwets24	PTVdry ≥ 36	PTVwets24	≥ 0.42
Min. 35 N/mm ²	max. 175 mm ³	8	PTVdry ≥ 36	PTVwets24	PTVdry ≥ 36	PTVwets24	≥ 0.42

Kırılma Dayanımı / Breaking Strength	Eğilme Dayanımı / Bending Strength	Derin Aşınma Dayanımı / Resistance to Deep Abrasion	MOHs	Pendulum Kuru TRL (55) / Pendulum Dry TRL (55)	Pendulum Islak TRL (55) / Pendulum Wet TRL (55)	Pendulum Kuru 4S (96) / Pendulum Dry 4S (96)	Pendulum Islak 4S (96) / Pendulum Wet 4S (96)
EN ISO 10545-4	EN ISO 10545-6	MOHs	BS 7976-2	BS 7976-2	BS 7976-2	BS 7976-2	ANSI A137.1 Section 9.6.1
Min. 35 N/mm ²	max. 175 mm ³	9	PTVdry ≥ 36	PTVwet ≥ 36	PTVdry ≥ 36	PTVwet ≥ 36	≥ 0.42
Min. 35 N/mm ²	max. 175 mm ³	9	PTVdry ≥ 36	PTVwet ≥ 36	PTVdry ≥ 36	PTVwet ≥ 36	≥ 0.42

Teknik Özellikler / Technical Characteristics

Technical Characteristics Teknik Özellikler Technische Eigenschaften Caractéristiques techniques	Test Standard Test Metodu Prüfung nach Méthode du test	PORCELAIN BODY Unglazed/Sırsız Unglasierte / non émaillés		PORCELAIN BODY Glazed/Sırlı Glasierte/ émaillés		FLOOR TILE BODY Glazed/Sırlı Glasierte/ émaillés		FLOOR TILE BODY Glazed/Sırlı Glasierte/ émaillés		WALL TILE BODY Glazed/Sırlı Glasierte/ émaillés	
		EN 14411 Group Bla Annex G		EN 14411 Group Bla Annex G		EN 14411 Group Blb Annex H		EN 14411 Group Blla Annex I		EN 14411 Group Blll Annex L	
		Nominal Size ≥ 15cm		Nominal Size ≥ 15cm		Nominal Size ≥ 15cm		Nominal Size ≥ 15cm		Nominal Size ≥ 15cm	
Dimension and surface quality											
Length and Width / Uzunluk ve Genişlik Länge und Breite / Longueur et largeur	EN ISO 10545-2	± 0,6%	± 2mm	± 0,6%	± 2mm	± 0,6%	± 2mm	± 0,6%	± 2mm	± 0,5 %	± 2mm
Thickness / Kalınlık Dicke / Epaisseur	EN ISO 10545-2	± 5%	± 0,5mm	± 5%	± 0,5mm	± 5%	± 0,5mm	± 5%	± 0,5mm	+ 10%	± 0,5mm
Thickness / Kalınlık Dicke / Epaisseur	EN ISO 10545-2	± 0,5%	± 1,5mm	± 0,5%	± 1,5mm	± 0,5%	± 1,5mm	± 0,5%	± 1,5mm	+ 0,3%	± 1,5mm
Thickness / Kalınlık Dicke / Epaisseur	EN ISO 10545-2	± 0,5%	± 2mm	± 0,5%	± 2mm	± 0,5%	± 2mm	± 0,5%	± 2mm	± 0,5%	± 2mm
Thickness / Kalınlık Dicke / Epaisseur	EN ISO 10545-2	± 0,5%	± 2mm	± 0,5%	± 2mm	± 0,5%	± 2mm	± 0,5%	± 2mm	± 0,5% - 0,3 %	± 2mm - 1,5mm
Surface Quality / Yüzey Kalitesi Oberflächenbeschaffenheit / Qualité de surface	EN ISO 10545-2	Min. 95 %		Min. 95 %		Min. 95 %		Min. 95 %		Min. 95 %	
Physical Properties											
Water Absorption / Su Emme Wasseraufnahme / Absorption d'eau	EN ISO 10545-3	± 0,5 %		± 0,5 %		0,5% < E ± 3,0 %		3,0% < E ± 6,0 %		E > 10%	
Modulus of rupture / Eğilme Dayanımı Biegefestigkeit / Résistance à la flexion	EN ISO 10545-4	Min. 35 N/mm ²		Min. 35 N/mm ²		Min. 30 N/mm ²		Min. 22 N/mm ²		Min. 15 N/mm ²	
Breaking Strength / Kırılma Dayanımı Bruchlast / Force de rupture	EN ISO 10545-4	Min.1300 N (t≥7,5mm) Min. 700 N (t<7,5mm)		Min.1300 N (t≥7,5mm) Min. 700 N (t<7,5mm)		Min. 1100 N (t≥7,5mm) Min. 700 N (t<7,5mm)		Min. 1000 N (t≥7,5mm) Min. 600 N (t<7,5mm)		Min.600N (t≥7,5mm) Min.200 N (t<7,5mm)	
Surface Abrasion / Yüzey Aşınma Widerstand gegen Oberflächenverschleiß / Résistance à l'abrasion PEI	EN ISO 10545-7	NA.		As specified in the catalogue		As specified in the catalogue		As specified in the catalogue		Not intended to be used on the floor	
Deep Abrasion / Derin Aşınma Widerstand gegen Tiefenverschleiß / Résistance à l'abrasion Profonde	EN ISO 10545-6	Max. 175 mm ³		NA.		NA.		NA.		NA.	
Linear Thermal Expansion / Lineer Isıl Genleşme / Lineer Wärmeausdehnungs koeffizient / Coeff. de dilatation therm. maxi	EN ISO 10545-8	Max 9 x 10 ⁻⁶ K ⁻¹		Max 9 x 10 ⁻⁶ K ⁻¹		Max 9 x 10 ⁻⁶ K ⁻¹		Max 9 x 10 ⁻⁶ K ⁻¹		Max 9 x 10 ⁻⁶ K ⁻¹	
Thermal Shock Resistance / Isı Şokuna Dayanım/ Temperaturwechselbeständigkeit / Résistance aux écarts de température	EN ISO 10545-9	Pass / Başarılı Erreicht / Conforme		Pass / Başarılı Erreicht / Conforme		Pass / Başarılı Erreicht / Conforme		Pass / Başarılı Erreicht / Conforme		Pass / Başarılı Erreicht / Conforme	
Frost Resistance / Don Dayanımı Frostbeständigkeit / Résistance au gel	EN ISO 10545-12	Pass / Başarılı Erreicht / Conforme		Pass / Başarılı Erreicht / Conforme		Pass / Başarılı Erreicht / Conforme		NPD		---	
Coefficient of friction / Sürtünme Katsayısı Reibungskoeffizient / Résistance à la glissance	Declared test method Beyan edilen metod Angabe Prüfverfahren	As specified in the catalogue		As specified in the catalogue		As specified in the catalogue		As specified in the catalogue		Not intended to be used on the floor	
Crazing resistance / Sırlı karolarda çatlamaya dayanım / Widerstand gegen Glassurrisse Résistance au tressailage	EN ISO 10545-11	---		Pass / Başarılı Erreicht / Conforme		Pass / Başarılı Erreicht / Conforme		Pass / Başarılı Erreicht / Conforme		Pass / Başarılı Erreicht / Conforme	
Reaction to Fire / Ateşe Dayanıklılık / Reaktion gegenüber Feuer / Réaction au feu	---	Class A1 or A1 _{FL}		Class A1 or A1 _{FL}		Class A1 or A1 _{FL}		Class A1 or A1 _{FL}		Class A1 or A1 _{FL}	
Small colour differences for plain coloured tiles / Tek renkli karolarda küçük renk farklılıkları / Farbabweichungen zwischen einfarbig glasierten keramischen Fliesen und Platten / de faibles différences de couleur entre carreaux céramiques de couleur unie	EN ISO 10545-16	ΔE < 1,0		ΔE < 0,75		ΔE < 0,75		ΔE < 0,75		ΔE < 0,75	
Chemical Resistance											
Staining resistance / Lekelenmeye Dayanım / Fleckbeständigkeit / Résistance aux taches	EN ISO 10545-14	Test Method Avaliable Test Metodu bulunur Prüfverfahren vorhanden Méthode d'essai applicable		Min. Class / Sınıf 3 Klasse/Classe 3		Min. Class / Sınıf 3 Klasse/Classe 3		Min. Class / Sınıf 3 Klasse/Classe 3		Min. Class / Sınıf 3 Klasse/Classe 3	
Resistance to household chemicals and swimming pool water cleaners / Ev kimyasalları ve yüzme havuzu temizleyicilerine dayanım / Beständigkeit gegen Haushaltschemikalien und Badewasserzusätze / Résistance aux produits ménagers	EN ISO 10545-13	Class / Sınıf Klasse/ Classe Min. B		Class / Sınıf Klasse/ Classe Min. B		Class / Sınıf Klasse/ Classe Min. B		Class / Sınıf Klasse/ Classe Min. B		Class / Sınıf Klasse/ Classe Min. B	
Resistance to low concentrations acids&alkalis / Düşük konsantrasyonlu asit ve alkali dayanımı / Beständigkeit gegen Säuren und Laugen mit niedriger Konzentration / Résistance aux produits bas concentration acides et bases	EN ISO 10545-13	Class / Sınıf Klasse/ Classe LA-LC		Class / Sınıf Klasse/ Classe LA-LC		Class / Sınıf Klasse/ Classe LA-LC		Class / Sınıf Klasse/ Classe LA-LC		Class / Sınıf Klasse/ Classe LA-LC	
Resistance to high concentrations acids&alkalis / Yüksek konsantrasyonlu asit ve alkali dayanımı / Beständigkeit gegen Säuren und Laugen mit hoher Konzentration / Résistance aux produits haut concentration acides et bases	EN ISO 10545-13	Class / Sınıf Klasse/ Classe HA-HC		Class / Sınıf Klasse/ Classe HA-HC		Class / Sınıf Klasse/ Classe HA-HC		Class / Sınıf Klasse/ Classe HA-HC		Class / Sınıf Klasse/ Classe HA-HC	

VitrA tiles conforms to EN 14411 Standard requirements which are specified in the related product groups with better values. / VitrA-Fliesen entsprechen den EN 14411 Standardanforderungen, die in den zugehörigen Produktgruppen mit besseren Werten angegeben sind. / Плитка «VitrA» отвечает требованиям Стандарта EN 14411, применимым к соответствующим группам продукции, с более высокими параметрами. / All references to as well as quotations from product and test standards are to be considered as information which is not binding. The latest versions apply. / Alle Verweise sowie Zitate aus Produkt- und Prüfnormen sind als unverbindliche Informationen zu betrachten. Die neuesten Versionen gelten. / Все ссылки и цитаты из продуктов и стандартов испытаний должны рассматриваться как необязательная информация. Применяются последние версии.

Performans Deklarasyonu - Kuru Preslenmiş Seramik Karolar Ala / Declaration of Performance - Dry-Pressed Ceramic Tiles Ala



Vitra Karo Sanayi ve Ticaret A.Ş. Şifa Mah. Hükümet Cad. Tuzla 34941 İSTANBUL -TURKEY

Info: www.vitra.com.tr

05

DoP No: D100-01

EN 14411:2016

Product / Ürün / Produkt / Produits

Extruded Ceramic Tiles, with water absorption Eb ≤ 0,5% - Group Ala
Düşük su emmeli çekme seramik karolar, su emme oranı Eb ≤ %0,5 - Grup Ala
Keramische Fliesen, Stranggepresste mit geringer Wasseraufnahme Eb ≤ 0,5% - Gruppe Ala
Carreaux céramiques étirés présentant une faible absorption d'eau Eb ≤ 0,5% - Groupe Ala

Intended use / Kullanım Alanı / Vorgesehene Verwendungszwecke / Usages prévus

For internal and external walls and flooring / İç ve Dış mekân zemin ve duvar kaplama
Wand und Boden; innen und außen / Pour murs et sols, d'intérieur et d'extérieur



Reaction to fire / Yangına tepki / Brandverhalten / Réaction au feu	Class/Sınıf/Klasse/Classe A1/A1 _{FL}	EN 14411:2016
Release of dangerous substance, for/Açığa çıkan tehlikeli maddeler / Abgabe gefährlicher Stoffe / Libération de substances dangereuses		
- Cadmium/Kadmiyum/Cadmium/Cadmium	NPD	EN 14411:2016
- Lead/Kurşun/Blei/Plomb	NPD	EN 14411:2016
Breaking Strength / Kırılma Dayanımı / Bruchlast / Résistance à la rupture (t= thickness, kalınlık, dicke, épaisseur)	> 1300 N (t≥ 7,5mm) > 600 N (t< 7,5mm)	EN 14411:2016
Slipperiness ⁽¹⁾ /Kaymaya Direnç ⁽¹⁾ / Rutschhemmende Eigenschaften ⁽¹⁾ / Glissance ⁽¹⁾	See technical documents and catalog Teknik doküman ve kataloglara bakınız Siehe bitte technische Dokuments und Katalog Voir les documents techniques et catalogues Test method-Test Metod-méthode d'essai-test methode CEN/ TS 16165	EN 14411:2016
Tactility/Hissedilebilir Yüzey/ Taktilität/Propriétés Tactiles	NPD	

Durability For/Dayanıklılık/ Dauerhaftigkeit bei/ Durabilité pour :

- Internal Use/iç mekan kullanım/ Anwendungen in Innenbereichen/ une utilisation en intérieur	Pass / Geçer / Bestanden/ Validé	EN 14411:2016
- External Use: Freeze-thaw resistance / Dış mekan kullanım-dona dayanım/ Anwendungen Beständigkeit/ une utilisation en extérieur - résistance aux gelées	Pass / Geçer / Bestanden/ Validé	EN 14411:2016

(1) Only if required by corresponding national statutory regulations / Sadece ilgili ülke mevzuatında gereklirse / Nur wenn erforderlich durch entsprechende nationale gesetzliche Regelungen / Seulement s'il y a lieu par des règlements statutaires nationaux correspondants

06032018 Rev01

Performans Deklarasyonu - Kuru Preslenmiş Seramik Karolar Bla / Declaration of Performance - Dry-Pressed Ceramic Tiles Bla



Vitra Karo Sanayi ve Ticaret A.Ş. Şifa Mah. Hükümet Cad. Tuzla 34941 İSTANBUL -TURKEY

Info: www.vitra.com.tr

05

DoP No: D200-01

EN 14411:2016

Product / Ürün / Produkt / Produits

Dry-Pressed Ceramic Tiles, with water absorption Eb ≤ 0,5% - Group Bla
Düşük su emmeli kuru preslenmiş seramik karolar, su emme oranı Eb≤%0,5 - Grup Bla
Keramische Fliesen, trocken gepresst mit geringer Wasseraufnahme Eb ≤ 0,5% - Gruppe Bla
Carreaux céramiques pressés à sec présentant une faible absorption d'eau Eb ≤0,5% - Groupe Bla

Intended use / Kullanım Alanı / Vorgesehene Verwendungszwecke / Usages prévus

For internal and external walls and flooring / İç ve Dış mekân zemin ve duvar kaplama
Wand und Boden; innen und außen/ Pour murs et sols, d'intérieur et d'extérieur



Reaction to fire / Yangına tepki / Brandverhalten / Réaction au feu	Class/Sınıf/Klasse/Classe A1/A1fl	EN 14411:2016
Release of dangerous substance, for/Açığa çıkan tehlikeli maddeler / Abgabe gefährlicher Stoffe/ Libération de substances dangereuses		
- Cadmium/Kadmiyum/Cadmium/Cadmium	NPD	EN 14411:2016
- Lead/Kurşun/Blei/Plomb	NPD	EN 14411:2016
Breaking Strength / Kırılma Dayanımı / Bruchlast / Résistance à la rupture (t= thickness, kalınlık, dicke, épaisseur)	> 1300 N (t≥ 7,5mm) > 700 N (t< 7,5mm)	EN 14411:2016
Slipperiness (t) /Kaymaya Direnç(t) / Rutschhemmende Eigenschaften(t) / Glissance(t)	See technical documents and catalog Teknik doküman ve kataloglara bakınız Siehe bitte technische Dokuments und Katalog Voir les documents techniques et catalogues Test method-Test Metod-méthode d'essai-test methode CEN/ TS 16165	EN 14411:2016
Tactility/Hissedilebilir Yüzey/ Taktilität/ Propriétés Tactiles	NPD	
Bond strength-adhesion for/Bağ Dayanımı - yapışma/Verbundfestigkeit-Haftfestigkeit/ Adhésion		
- For cementitious adhesives Typ C2/C2/çimento esaslı yapıştırıcı Tip C2/ Für zementhaltige Mörtel Typ C2/ Ciment colle type C2	≥ 0,5 N/mm ²	EN 14411:2016
- Dispersion adhesive/ Dispersiyon esaslı yapıştırıcı/ Dispersionsklebstoffe/ Dispersion de l'adhésif	NPD	EN 14411:2016
Reaction resin adhesive/Reaksiyon reçine esaslı yapıştırıcı / Reaktionsharzklebstoffe/ Réactif à la résine	NPD	EN 14411:2016
Thermal Shock Resistance / Isı Şokuna Dayanım Temperaturwechsel beständigkeit/ Résistance au choc thermique	Pass / Geçer / Bestanden/ Validé	EN 14411:2016
Durability For/Dayanıklılık/ Dauerhaftigkeit bei/ Durabilité pour :		
- Internal Use/İç mekan kullanım/ Anwendungen in Innenbereichen/ une utilisation en intérieur	Pass / Geçer / Bestanden/ Validé	EN 14411:2016
- External Use: Freeze-thaw resistance / Dış mekan kullanım-dona dayanım/ Anwendungen in Außenbereichen:Frost-Tauwechsel- Beständigkeit/ une utilisation en extérieur - résistance aux gelées	Pass / Geçer / Bestanden/ Validé	EN 14411:2016

(t) Only if required by corresponding national statutory regulations / Sadece ilgili ülke mevzuatında gereklirse / Nur wenn erforderlich durch entsprechende nationale gesetzliche Regelungen / Seulement s'il y a lieu par des règlements statutaires nationaux correspondants

Performans Deklarasyonu - Kuru Preslenmiş Seramik Karolar Blb / Declaration of Performance - Dry-Pressed Ceramic Tiles Blb



Vitra Karo Sanayi ve Ticaret A.Ş. Şifa Mah. Hükümet Cad. Tuzla 34941 İSTANBUL -TURKEY
Info: www.vitra.com.tr
05
DoP No: D300-01

EN 14411:2016

Product / Ürün / Produkt / Produits

Dry-Pressed Ceramic Tiles, with water absorption $0,5\% < Eb \leq 3\%$ - Group Blb
Düşük su emmeli kuru preslenmiş seramik karolar Su emme oranı $\%0,5 < Eb \leq 3$ - Grup Blb
Keramische Fliesen, trockenengepresst mit geringer Wasseraufnahme $0,5\% < Eb \leq 3\%$ - Gruppe Blb
Carreaux céramiques pressés à sec présentant une faible absorption d'eau $0,5\% < Eb \leq 3\%$ - Groupe Blb

Intended use / Kullanım Alanı / Vorgesehene Verwendungszwecke / Usages prévus

For internal and external walls and flooring / İç ve Dış mekân zemin ve duvar kaplama
Wand und Boden; innen und außen / Pour murs et sols, d'intérieur et d'extérieur



Reaction to fire / Yangına tepki / Brandverhalten / Réaction au feu	Class/Sınıf/Klasse/Classe A1 / A1 _L	EN 14411:2016
Release of dangerous substance, for/Açığa çıkan tehlikeli maddeler / Abgabe gefährlicher Stoffe/ Libération de substances dangereuses		
- Cadmium/Kadmiyum/Cadmium/Cadmium	NPD	EN 14411:2016
- Lead/Kurşun/Blei/Plomb	NPD	EN 14411:2016
Breaking Strength / Kırılma Dayanımı / Bruchlast / Résistance à la rupture (t= thickness, kalınlık, dicke, épaisseur)	> 1100 N (t _z 7,5mm) > 700 N (t _c 7,5mm)	EN 14411:2016
Slipperiness ⁽¹⁾ / Kaymaya Direnç ⁽¹⁾ / Rutschhemmende Eigenschaften ⁽¹⁾ / Glissance ⁽¹⁾	See technical documents and catalog Teknik doküman ve kataloglara bakınız Siehe bitte technische Dokuments und Katalog Voir les documents techniques et catalogues Test method-Test Metod-méthode d'essai-test methode CEN/ TS 16165	EN 14411:2016
Tactility/Hissedilebilir Yüzey/ Taktilität/ Propriétés Tactiles	NPD	
Bond strength-adhesion for/Bağ Dayanımı - yapışma/Verbundfestigkeit-Haftfestigkeit/ Adhésion		
- For cementitious adhesives Typ C2/Çimento esaslı yapıştırıcı Tip C2/ Für zementhaltige Mörtel Typ C2/ Ciment colle type C2	≥ 0,5 N/mm ²	EN 14411:2016
- Dispersion adhesive/ Dispersiyon esaslı yapıştırıcı/ Dispersionsklebstoffe/ Dispersion de l'adhésif	NPD	EN 14411:2016
- Reaction resin adhesive/Reaksiyon reçine esaslı yapıştırıcı / Reaktionsharzklebstoffe/ Réactif à la résine	NPD	EN 14411:2016
- Thermal Shock Resistance / Isı Şokuna Dayanım / Temperaturwechsel beständigkeit/ Résistance au choc thermique	Pass / Geçer / Bestanden/ Validé	EN 14411:2016
Durability For/Dayanıklılık/ Dauerhaftigkeit bei/ Durabilité pour :		
- Internal Use/iç mekan kullanım/ Anwendungen in Innenbereichen/ une utilisation en intérieur	Pass / Geçer / Bestanden/ Validé	EN 14411:2016
- External Use: Freeze-thaw resistance / Dış mekan kullanım-dona dayanım/ Anwendungen in Außenbereichen/Frost-Tauwechsel- Beständigkeit/ une utilisation en extérieur - résistance aux gelées	Pass / Geçer / Bestanden/ Validé	EN 14411:2016

(1) Only if required by corresponding national statutory regulations / Sadece ilgili ülke mevzuatında gerekiyse / Nur wenn erforderlich durch entsprechende nationale gesetzliche Regelungen / Seulement s'il y a lieu par des règlements statutaires nationaux correspondants

Performans Deklarasyonu - Kuru Preslenmiş Seramik Karolar BIII / Declaration of Performance - Dry-Pressed Ceramic Tiles BIII



Vitra Karo Sanayi ve Ticaret A.Ş. Şifa Mah. Hükümet Cad. Tuzla 34941 İSTANBUL -TURKEY
Info: www.vitra.com.tr
05
DoP : D400-01

EN 14411:2016

Product / Ürün / Produkt / Produits

Dry-Pressed Ceramic Tiles, with water absorption Eb > 10 % - Group BIII
Kuru preslenmiş seramik karolar, su emme oranı Eb > %10 - Grup BIII
Keramische Fliesen, trocken gepresst mit hoher Wasseraufnahme Eb > 10% - Gruppe BIII
Carreaux céramiques pressés à sec Eb > 10% - Groupe BIII

Intended use / Kullanım Alanı / Vorgesehene Verwendungszwecke / Usages prévus

For internal walls / İç duvar kaplama
Wandbeläge innen / Revêtements muraux à l'intérieur



Reaction to fire / Yangına Tepki / Brandverhalten / Réaction au feu	Class/Sınıf/Klasse/Classe A1	EN 14411:2016
Release of dangerous substance, for/ Açığa çıkan tehlikeli maddeler / Abgabe gefährlicher Stoffe/ Libération de substances dangereuses		
- Cadmium/Kadmiyum/Cadmium/Cadmium	NPD	EN 14411:2016
- Lead/Kurşun/Blei/Plomb	NPD	EN 14411:2016
Breaking Strength / Kırılma Dayanımı / Bruchlast / Résistance à la rupture (t= thickness, kalınlık, dicke, épaisseur)	> 600 N (t≥ 7,5mm) > 200 N (t< 7,5mm)	EN 14411:2016
Bond strength-adhesion for/Bağ Dayanımı - yapışma/Verbundfestigkeit-Haftfestigkeit/ Adhésion		
- For cementitious adhesives Typ C1/Çimento esaslı yapıştırıcı Tip C1/ Für zementhaltige Mörtel Typ C1/ Ciment colle type C1	≥ 0,5 N/mm2	EN 14411:2016
- Dispersion adhesive/ Dispersiyon esaslı yapıştırıcı/ Dispersionsklebstoffe/ Dispersion de l'adhésif	NPD	EN 14411:2016
- Reaction resin adhesive/Reaksiyon reçine esaslı yapıştırıcı / Reaktionsharzklebstoffe / Réactif à la résine	NPD	EN 14411:2016
- Thermal Shock Resistance / Isı Şokuna Dayanım / Temperaturwechsel beständigkeit / Résistance au choc thermique	Pass / Geçer / Bestanden/ Validé	EN 14411:2016
Durability For/Dayanıklılık/ Dauerhaftigkeit bei/ Durabilité pour :		
- Internal Use/İç mekan kullanım/ Anwendungen in Innenbereichen/ une utilisation en intérieur	Pass / Geçer / Bestanden/ Validé	EN 14411:2016

06032018 Rev01

Performans Deklarasyonu - Kuru Preslenmiş Seramik Karolar B11a / Declaration of Performance - Dry-Pressed Ceramic Tiles B11a



VitrA Karo Sanayi ve Ticaret A.Ş. Şifa Mah. Hükümet Cad. Tuzla 34941 İSTANBUL - TURKEY

Info: www.vitra.com.tr

05

DoP No: D300-01

EN 14411:2016

Product / Ürün / Produkt / Produits

Dry-Pressed Ceramic Tiles, with water absorption 3% < Eb ≤ 6 % - Group B11a
Kuru preslenmiş seramik karolar Su emme oranı 3% < Eb ≤ 6 % - Group B11a
Keramische Fliesen, trocken gepresst mit Wasseraufnahme 3% < Eb ≤ 6 % - Group B11a
Carreaux céramiques pressés à sec présentant une absorption d'eau 3% < Eb ≤ 6 % - Group B11a

Intended use / Kullanım Alanı / Vorgesehene Verwendungszwecke / Usages prévus

For internal walls and flooring / İç mekan zemin ve duvar kaplama
Wand und Boden; innen / Pour murs et sols, d'intérieur



Reaction to fire / Yangına tepki / Brandverhalten / Réaction au feu	Class/Sınıf/Klasse/Classe A1 / A1 _{FL}	EN 14411:2016
Release of dangerous substance, for/Açığa çıkan tehlikeli maddeler / Abgabe gefährlicher Stoffe/ Libération de substances dangereuses		
- Cadmium/Kadmium/Cadmium/Cadmium	NPD	EN 14411:2016
- Lead/Kurşun/Blei/Plomb	NPD	EN 14411:2016
Breaking Strength / Kırılma Dayanımı / Bruchlast / Résistance à la rupture (t= thickness, kalınlık, dicke, épaisseur)	> 1100 N (t≥ 7,5mm) > 600 N (t< 7,5mm)	EN 14411:2016
Slipperiness ⁽¹⁾ /Kaymaya Direnç ⁽¹⁾ / Rutschhemmende Eigenschaften ⁽¹⁾ / Glissance ⁽¹⁾	See technical documents and catalog Teknik döküman ve kataloglara bakınız Siehe bitte technische Dokumente und Katalog Voir les documents techniques et catalogues Test method-Test Metod-méthode d'essai-test methode CEN/ TS 16165	EN 14411:2016
Tactility/Hissedilebilir Yüzey/ Taktilität/ Propriétés Tactiles	NPD	
Bond strength-adhesion for/Bağ Dayanımı - yapışma/Verbundfestigkeit-Haftfestigkeit/ Adhésion		
- For cementitious adhesives Typ C2/Çimento esaslı yapıştırıcı Tip C2/ Für zementhaltige Mörtel Typ C2/ Ciment colle type C2	≥ 0,5 N/mm ²	EN 14411:2016
- Dispersion adhesive/ Dispersiyon esaslı yapıştırıcı/ Dispersionsklebstoffe/ Dispersion de l'adhésif	NPD	EN 14411:2016
- Reaction resin adhesive/Reaksiyon reçine esaslı yapıştırıcı / Reaktionsharzklebstoffe/ Réactif à la résine	NPD	EN 14411:2016
- Thermal Shock Resistance / Isı Şokuna Dayanım / Temperaturwechsel beständigkeit/ Résistance au choc thermique	Pass / Geçer / Bestanden/ Validé	EN 14411:2016
Durability For/Dayanıklılık/ Dauerhaftigkeit bei/ Durabilité pour :		
- Internal Use/İç mekan kullanım/ Anwendungen in Innenbereichen/ une utilisation en intérieur	Pass / Geçer / Bestanden/ Validé	EN 14411:2016

(1) Only if required by corresponding national statutory regulations / Sadece ilgili ülke mevzuatında gerekiyse / Nur wenn erforderlich durch entsprechende nationale gesetzliche Regelungen / Seulement s'il y a lieu par des règlements statutaires nationaux correspondants

06032018 Rev00

TS EN 14411 Standardına Göre Sınıflandırmalar ve Terimler

Karolar genellikle oda sıcaklığında çekme veya kuru presleme ile şekillendirilir, ardından gerekli özellikleri sağlamak için yeterli sıcaklıklarda kurutulur ve fırınlanır. Başka üretim prosesleri ile de oluşturulabilirler, ancak bunlar Avrupa Standardı kapsamında değildir. Karolar, sırlı (GL) veya sırsız (UGL) olabilir. Angop uygulanmış karolar, sırsız karo olarak kabul edilir.

Tablo 1. Su emme kapasitesi ve şekillendirme özelliklerine göre seramik karoların sınıflandırılması

Şekillendirme	Grup I $E \leq 0.5\%$	Grup II _a $3\% < E \leq 6\%$	Grup II _b $6\% < E \leq 10\%$	Grup III $E > 10\%$
A Çekme Karolar	Grup AI _a $E \leq 0.5\%$ (ek M)	Grup AII _{a-1} (ek B)	Grup AII _{b-1} (ek D)	Grup AIII (ek F)
	Grup AI _b $0.5\% < E \leq 3\%$ (ek A)	Grup AII _{a-2} (ek C)	Grup AII _{b-2} (ek E)	
B Kuru Preslenmiş Karolar	Grup BI _a $E \leq 0.5\%$ (ek G)	Grup BII _a (ek J)	Grup BII _b (ek K)	Grup BIII (ek L)
	Grup BI _b $0.5\% < E \leq 3\%$ (ek H)			

Geleneksel olarak kullanılan terimler aşağıdaki gibidir:

Seramik Karo

Kil ve/veya diğer inorganik ham maddelerden elde edilen karodur.

Çekme Seramik Karo

Karo hamurunun plastik halde bir ekstruderde şekillendirilmesi ile elde edilen, kütlenin önceden belirlenmiş boyutlarda kesilmesi ile üretilen seramik karolardır.

Kuru Preslenmiş Karo

Çok ince öğütülmüş ana karışımın preslenerek şekillendirilmesi ile elde edilen karodur.

Porselen Seramik Karo

Su emme kapasitesi % 0,5 veya daha az olacak şekilde tamamen sırlanmış (vitrifiye edilmiş) seramik karodur.

Mozaik

Küçük porselen karoların fileye yapıştırılmasıyla oluşan karolardır.

Su emme kapasitesi E, seramik gövde tarafından emilen suyun yüzdesini (kütlece) belirtir, TS EN ISO 10545-3'e göre deney yapılır.

Terms and Classification according to TS EN 14411

Tiles are usually shaped by extruding or dry-pressing at room temperature followed by drying and firing at temperatures sufficient to develop the required properties. They can also be formed by other processes, but these are not covered by this European Standard. Tiles can be glazed (GL) or unglazed (UGL). A tile with an engobed surface is regarded as an unglazed tile.

Table 1. Classification of the ceramic tiles according to their groups of water absorption (E) and their shaping

Shaping	Group I $E \leq 0.5\%$	Group II _a $3\% < E \leq 6\%$	Group II _b $6\% < E \leq 10\%$	Group III $E > 10\%$
A Extruded Tiles	Group AI _a $E \leq 0.5\%$ (see annex M)	Group AII _{a-1} (see annex B)	Group AII _{b-1} (see annex D)	Group AIII (see annex F)
	Group AI _b $0.5\% < E \leq 3\%$ (see annex A)	Group AII _{a-2} (see annex C)	Group AII _{b-2} (see annex E)	
B Dry Pressed Tiles	Group BI _a $E \leq 0.5\%$ (see annex G)	Group BII _a (see annex J)	Group BII _b (see annex K)	Group BIII (see annex L)
	Group BI _b $0.5\% < E \leq 3\%$ (see annex H)			

Traditionally the following terms are used:

Ceramic tiles

Tile made from clays and/or other inorganic raw materials.

Extruded tiles

Ceramic tile whose body is shaped in the plastic state in an extruder, the coulumn obtained being cut into tiles of pre-determined dimension.

Dry-pressed tiles

Tile formed from a finely milled body mixture and shaped by pressing.

Porcelain tiles

Fully vitrified ceramic tile with water absorption of 0,5% or less.

Mosaics

Tiles that are small (porcelain) stoneware tiles stuck onto sheets.

The water absorption E in weight-% is determined in accordance with EN ISO 10545-3.

Boyut ve Yüzey Kalitesi

1. Boyut, TS EN ISO 10545-2

Tüm boyutlar standartlara uygun olarak belirlenir.

EN 14411	Group Ala		Grup Bla / Blb/ Blla	Grup Blll
	Doğal	Hassas		
Her bir karonun ortalama boyutunun çalışma boyutundan (W) sapması	± 2% en çok ±4 mm	± 1.0% en çok ±2 mm	± 0.6% ve ±2,0 mm	± 0.5% ve ± 2,0 mm

2. Yüzey Kalitesi, TS EN ISO 10545-2

En az 1 m² ve en az 30 adet karo, üst yüzeyleri 1 m mesafeden dik olarak görülecek şekilde 300 lx ışık altında incelenir. Kalite 1 için, karoların en az %95'i, asıl görünümü bozan yüzey hatalarından arındırılmış olmaktadır.

3. Boyutlandırma (Kalibre)

Üretim boyutları teknik nedenlerden dolayı değişmektedir. Üretim boyutu kutu üzerine yazılır ve işaretlenir. Sadece aynı kalibreye sahip kutular/karolar birlikte döşenmelidir.

Fiziksel Özellikler

1. Su Emme, TS EN ISO 10545-3

Test edilen her tipteki karo, 10 adet bütün karodan oluşmaktadır. Su emme aşağıdaki formül kullanılarak hesaplanır:

$$E = (m_2 - m_1) / m_1 \times 100$$

m² ıslak karo kütlesi;

m¹ kuru karo kütlesi

Su emme değeri (E), su ile doyurulmuş numunelerin kuru ağırlığına kıyasla ağırlık artışını % olarak verir.

1.1. Görünen Gözeneklilik, TS EN ISO 10545-3

Görünen gözeneklilik, deney numunesinin açık gözeneklerin hacminin dış hacmine oranının yüzdesi olarak ifade edilir.

2. Kopma Modülü ve Kırılma Dayanımı, TS EN ISO 10545-4

Bir karonun kırılma dayanımı, kırılma yükü ve kopma modülü karonun merkezine belirli bir oranda kuvvet uygulayarak belirlenir.

Örnekleme üretim partisinden rassal olarak yapılır.

Gereken test numunesi adetleri;

Karo boyutu mm cinsinden	Gereken test numune adedi (en az)
18 < L ≤ 48	10
48 < L ≤ 1000	7
L > 1000	5

Kırılma dayanımı aşağıdaki formül ile hesaplanır,

Breaking strength; $S = FL/b$

Modulus of rupture; $R = 3FL/(2bh^2)$

where

• F Kırılma yükü; (Newton)

• L Mesnet çubukları arasındaki açıklık (mm)

• B Deney numunesinin genişliği (mm)

• h Deney numunesinin deneyden sonra kırılmış kenar boyunca ölçülen en küçük kalınlığı (mm)

Dimensions and Surfaces

1. Dimensions, EN ISO 10545-2

All dimensions are determined in accordance with the standard.

EN 14411	Group A Ia		Group B Ia / B Ib/ B IIa	Group B III
	Nature	Precision		
The permissible deviation of the average size for each tile from the work size (W)	± 2% to a maximum of ±4 mm	± 1.0% to a maximum of ±2 mm	± 0.6% and ±2,0 mm	± 0.5% and ± 2,0 mm

2. Surface Quality, EN ISO 10545-2

At least 1 m² of tiles and a minimum of 30 of them shall be examined at 300 lux for visible defects at a distance of 1 m. For quality 1, a minimum of 95% of the tiles shall be free from visible defects that would impair the appearance of a major area of tiles.

3. Size Grading (Calibre)

The production sizes vary for technical reasons. The production size is coded and stamped on the box. Only boxes with the same calibre should be laid together.

Physical Properties

1. Water Absorption, EN ISO 10545-3

A sample of each type of tile under test shall consist of 10 whole tiles. Using the below formula,

$$E = (m_2 - m_1) / m_1 \times 100$$

m₂ is the mass of the wet tile;

m₁ is the mass of the dry tile

The water absorption (E) gives the weight increase in % as compared to the dry weight of boiled samples saturated with water.

1.1. Apparent Density, EN ISO 10545-3

It gives the ratio between mass and external volume.

2. Modulus of Rupture, EN ISO 10545-4

Breaking strength, breaking load and modulus of rupture of a tile are determined by applying a force at a definite rate to the centre of a tile. Specimens are selected arbitrarily from the part.

Minimum number of test specimens are;

Dimension of the tile in mm	Minimum number of test specimens
18 < L ≤ 48	10
48 < L ≤ 1000	7
L > 1000	5

Breaking strength is calculated by using the below formula,

Breaking strength; $S = FL/b$

Modulus of rupture; $R = 3FL / (2bh^2)$

where

• F is the breaking load; in Newtons

• L is the bearing span, in millimeters

• B is the width of the test specimen, in millimeters

• h is the minimum thickness of the test specimen, in millimeters

VitrA Teknik Özellikler

3. Çarpma Dayanımı, TS EN ISO 10545-5

Testte kullanılan beş karodan 75 mm x 75 mm boyutunda en az 5 parça, sabit bir yükseklikten test numunesi üzerine çelik bilyenin düşürülmesi ve sıçrama yüksekliğinin ölçülmesi ile geri gelme katsayısının belirlenmesi için kullanılmaktadır.

4. Derin Aşınma Dayanımı, TS EN ISO 10545-6

Derin aşınma testi, bütün haldeki karolar veya uygun boyutlardaki test numuneleri kullanılarak gerçekleştirilmektedir. Testten önce, küçük boyuttaki numuneler, derzlerden kaçınarak daha büyük bir arka plan üzerine yapıştırıcı ile sabitlenmektedir. Amaç, belirli koşullar altında ve aşındırıcı malzemenin kullanımıyla, dönen bir çelik disk vasıtasıyla yüzeyde oluşan çukur alanın uzunluğunu ölçerek, sırsız karoların aşınma direncini belirlemektir.

5. Yüzey Aşınma, TS EN ISO 10545-7

Islak test ile sırlı karoların aşınma sınıfları belirlenir. Yapay aşınma; alüminyum oksit tanecikleri, çelik bilyeler ve eksantrik olarak dönen bir sistemde suyun eklenmesiyle sağlanır. Test yüzeyinde gözle görülür bir değişimin meydana geldiği devir sayısı, aşağıdaki sınıflandırma ile sonuçlanır:

Aşınma Kademesi, Kusurun görüldüğü devirler	Sınıf
100	0
150	1
600	2
750, 1500	3
2100, 6000, 12000	4
>12000*	5

* EN ISO 10545-14'te belirtilen lekelenmeye dayanıklılık deneyini başarıyla geçmelidir.

Aşınma Sınıfı	Kullanım Alanları
Sınıf 0	Bu sınıflandırmaya sahip ürünler yer karosu olarak kullanıma uygun değildir.
Sınıf 1	Yumuşak tabanlı ayakkabı veya çıplak ayakla yürünen bölgelerde aşındırıcı kire maruz kalmayan alanlarda kullanıma uygundur. Örneğin; evlerde banyo ve yatak odası.
Sınıf 2	Bu sınıf, yumuşak veya normal tabanlı ayakkabılarla sık olarak yürünmeyen ve yalnızca az miktarda aşındırıcı kirlenmeye maruz kalan alanlarda kullanım için uygundur. Örneğin; mutfak, giriş, teras, merdiven ve yoğun olarak kullanılan odalar hariç olmak üzere, evlerdeki yaşam alanları.
Sınıf 3	Normal ayakkabılarla ve aşındırıcı kirlenmeye maruz kalan yerlerdeki zeminlerde kullanıma uygundur. Örneğin; Evdeki tüm odalar banyo, mutfak, giriş, merdiven vb.
Sınıf 4	Sık yürünen ve sık yoğun kirlenmeye maruz kalan bölgelerdeki zeminler için uygundur. Örneğin; ticari mutfaklar, teraslar, ofisler, oteller, okullar, hastaneler vb.
Sınıf 5	Aşınma direnci en yüksek olan bu sınıf, yaya trafiğine ve aşındırıcı yoğun kirliliğe maruz kalan alanlarda kullanmak için uygundur. Örneğin; alışveriş merkezleri, havaalanları, bankalar, restoranlar vb.

6. Doğrusal Isıl Genleşme, TS EN ISO 10545-8

Bu testin amacı, ortam sıcaklığı ile 100 °C arasındaki sıcaklık aralığı için doğrusal ısı genleşme katsayısını belirlemektir. Test için bir karonun orta kısmından, cihaza uygun boylarda, birbirine dik açı yapacak şekilde, iki adet deney numunesi kesilmektedir. Deney numunelerinin uçları, düzgün ve birbirine paralel olarak taşlanmaktadır.

Lineer ısı genleşme katsayısı, α , 10⁻⁶/°C birimiyle ifade edilir. Aşağıdaki formül yardımıyla hesaplanır:

$$\alpha = \frac{1}{L_0} \times \frac{\Delta L}{\Delta t}$$

where

- L₀ Deney numunesinin ortam sıcaklığındaki uzunluğu,
- ΔL Ortam sıcaklığı ile 100 °C arasında deney numunesinin uzunluk artışı,
- Δt Sıcaklık artışı

VitrA Technical Properties

3. Resistance to Shock, EN ISO 10545-5

A minimum of 5 pieces in dimensions 75 mm x 75 mm cut from five tiles used in the test for determination of the coefficient of restitution by dropping a steel ball from a fixed height onto the test specimen and measuring the height of rebound.

4. Resistance to Deep Abrasion, EN ISO 10545-6

Tests shall be carried out using whole tiles or test specimens of suitable dimensions. Before testing, small specimens shall be fixed with an adhesive on to a larger background, avoiding joints. Purpose is to determine the abrasion resistance of unglazed tiles by measuring the length of the groove produced in the proper surface by means of a rotating steel disc, under given conditions and with the use of abrasive material.

5. Glaze Abrasion, EN ISO 10545-7

The abrasion class of glazed tiles is established in the wet test. Artificial abrasion is produced with the help of aluminium oxide grains, steel balls and the addition of water in an eccentrically revolving system. The number of revolutions at which a visible change of the test surface occurs results in the following classification:

Abrasion stage, Failure visible at revolutions	Class
100	0
150	1
600	2
750, 1500	3
2100, 6000, 12000	4
>12000*	5

* Must pass the stain test according to EN ISO 10545-14

Abrasion Class	Usage Areas
Class 0	The use of glazed tiles of this class is unsuitable for floor.
Class 1	For using the tiles in areas walked on in soft footwear or barefoot and no abrasive dirt contamination. For example; bathrooms and bedrooms in the houses.
Class 2	This class is suitable for usage of tiles in areas infrequently walked on with soft or normal shoes and exposed to only small amount of abrasive dirt contamination. For example; rooms in living areas of houses, except kitchens, entrances, terraces, stairs and heavily frequented used rooms.
Class 3	For floors in areas subject to frequently walking on with normal shoes and abrasive dirt contamination. For example; all rooms in the house including bathrooms, kitchens, entrances, stairs etc.
Class 4	For floors in areas subject to frequently walking and frequent, intense soiling. For example; commercial kitchens, terraces, offices, hotels, schools, hospitals etc.
Class 5	This class is the highest for the wear resistance is suitable for using the tiles in areas that subject to heavy pedestrian traffic and abrasive dirt contamination. For example; shopping centres, airports, banks, restaurants etc.

6. Linear Thermal Expansion, EN ISO 10545-8

The test is used to determine linear thermal expansion coefficient for the temperature range from ambient temperature to 100°C and prepared by cutting two test specimens at right angles from the central portion of one tile so that their lengths are suitable for the apparatus. Then ends of the test specimens shall be ground flat and parallel.

The linear thermal expansion coefficient, α , is expressed in 10^{-6} per degree Celsius ($10^{-6}/^{\circ}\text{C}$), to the first decimal place, in accordance with the expression

$$\alpha = \frac{1}{L_0} \times \frac{\Delta L}{\Delta t}$$

where

- L_0 is the length of the test specimen at the ambient temperature;
- ΔL is the increase in length of the test specimen between ambient temperature and 100 °C;
- Δt is the rise in temperature

VitrA Teknik Özellikler

7. Isı Şokuna Dayanıklılık, TS EN ISO 10545-9

Testin amacı, bütün bir karonun 15 °C ve 145 °C sıcaklıklar arasında 10 defa çevirim yapılarak ısı şokuna dayanıklılığını belirlemektir. En az 5 bütün karo test edilir.

8. Rutubet Genleşmesi, EN 10545-10

Amaç, karolarda rutubet genleşmesini belirlemektir. Rutubet genleşmesi, yeniden ısıtılıp soğutulan karonun kaynar su içerisine daldırılarak geniştirilmesi sonucunda oluşan hızlandırılmış bağıl genleşmedir. Beş bütün karo test edilir.

9. Sırın Çatlama Dayanımı, EN 10545-11

Sır çatlağı, karonun sadece sırlı yüzeyinde oluşmuş, saç teli inceliğinde, kılcal çatlaktır. En az beş adet bütün karo denir. İstisna olarak, büyük karolar otoklava sığması için kesilebilir, fakat bu durumda kesilen bütün parçalar deneye alınır. Kesilen parçalar mümkün olduğu kadar büyük olmalıdır.

10. Dona Dayanıklılık, TS EN ISO 10545-12

Dona dayanıklılık, dış mekanlarda kullanılacak karolar için şarttır. EN 14411'e göre Grup Bla porselen ve Grup Blb seramik karolar dona dayanım şartını sağlamış olmalıdır. Ancak, hatalı olarak veya uygunsuz bir zemin üzerine döşenen karolarda, standartlara uygun olsa bile dondan hasar oluşabilir.

11. Küçük Renk Farklıları, TS EN ISO 10545-16

Bir örnek ve birbirine uygun renk vermesi için tasarlanmış, tek renkli sırlı/sırsız seramik karolar arasındaki küçük renk farklılıklarını tayin etmek için kullanılır. Numuneler referans numune ile karşılaştırıldığında iki ana gruba ayrılır. ΔE_{cmc} değerleri önceden kabul edilebilen en uygun toleranstan küçük veya ona eşit olanlar kabul edilir. ΔE_{cmc} değerleri önceden kabul edilebilen uygun toleranstan büyük olanlar kabul edilmez.

12. Yangına Tepki

Seramik karolar TS EN ISO 13501-1 ve EN 14411'e göre A1 olarak sınıflandırılmıştır. Bu sebeple, genellikle yanmaz ve dolayısıyla ateşe dayanıklıdır. Ayrıca yangın durumunda, herhangi bir toksik madde yaymazlar.

VitrA Technical Properties

7. Thermal Shock Resistance, EN ISO 10545-9

Purpose of the test is to determine the resistance of thermal shock of a whole tile by cycling 10 times between the temperatures of 15 °C and 145 °C.

A minimum of five whole tiles shall be tested.

8. Moisture Expansion, EN 10545-10

The test is performed to determine moisture expansion which is proportional accelerated expansion that results from subjecting reheated tiles to extended immersion in boiling water.

A sample consists of five whole tiles.

9. Crazing Resistance, EN 10545-11

Crazing refers to the fine hairline cracks to be found in the glaze of nonvitreous tiles and glass plating.

A minimum of five whole tiles shall be tested and exceptionally large tiles may be cut into pieces for enclosure in the autoclave, but all pieces shall be tested. The cut pieces shall be as large as possible.

10. Frost Resistance, EN ISO 10545-12

Main criterion for using tiles outdoors. Required, according to EN 14411 Group BIa for porcelain stoneware and EN 14411 group BIb for vitreous tiles. Frost damage can occur, however, even with tiles complying with standards, if they are laid incorrectly or on defective substrate.

11. Colour Deviations, EN ISO 10545-16

For quantifying the small colour differences between plain coloured ceramic tiles, which are designed to be of uniform and consistent colour.

Specimens which are compared to a reference standard will fall into two categories: those are which the ΔE_{cmc} values are less than or equal to the agreed upon tolerance are acceptable (pass), while those for which the ΔE_{cmc} values are greater than the agreed upon tolerance are unacceptable (fail).

12. Behaviour in Fire

Ceramic tiles are classified A1 according to EN ISO 13501-1 and EN 14411. Therefore, they are generally non-combustible and thus fire-resistant. Also in the case of fire they do not release any toxic emissions.

Kimyasal Özellikler

1. Kimyasal Maddelere Dayanıklılık, TS EN ISO 10545-13

Testin amacı, deney numunelerini deney çözeltilerinin etkisine maruz bırakmak ve belirli bir süre sonunda oluşabilecek hasarı gözle incelemektir.

Ortam	Konsantrasyon
1 Sulu deney çözeltileri	
1.1 Ev kimyasalları / yüzme havuzu tuzları	
Amonyum klorür çözeltisi	100 g/l
Sodyum hipoklorit çözeltisi	20 mg/l
Sınıflandırma grupları	A/B/C
1.2 Asit ve Alkaliler	
1.2.1 Düşük Konsantrasyonlar (L)	
Hidroklorik asit çözeltisi	3%
Sitrik asit çözeltisi	100 g/l
Potasyum hidroksit çözeltisi	30 g/l
Sınıflandırma grupları	LA/LB/LC
1.2.2 Yüksek Konsantrasyonlar (H)	
Hidroklorik asit çözeltisi	18%
Laktik asit çözeltisi	5%
Potasyum hidroksit çözeltisi	100 g/l
Sınıflandırma grupları	HA/HB/HC

* A sınıfı, kimyasallara karşı en yüksek dayanımı gösterir, bu da C'ye doğru gittikçe azalır.

Test numunelerinin sayısı aşağıdaki gibidir:

Karo Alanı, A (cm ²)	Toplam deney numune sayısı (karo)
200 < A ≤ 3600	3
A > 3600	3

Alan 200 cm²'e eşit veya küçükse, 200 cm²'yi kaplayacak kadar deney numunesi yeterlidir.

2. Lekelenmeye Dayanıklılık, TS EN ISO 10545-14

Karoların üst yüzeyinin deney çözeltileri ve maddeleri ile uygun bir süre boyunca temas halinde bulundurulması, daha sonra yüzeylerin belirli temizleme metodlarına tâbi tutulması ve son olarak görüntü değişikliklerinin kontrol edilmesi ile lekelenmeye dayanıklılıklarının tayinidir.

Kullanılan kimyasallar aşağıdaki gibidir:

- Kalıntı Bırakan Lekelendiriciler

İnce Yağ İçinde Yeşil Lekelendirici Madde

İnce Yağ İçinde Kırmızı Lekelendirici Madde

- Kimyasal Ve Oksitleyici Etkili Lekelendiriciler

İyot, alkoldeki 13 g/l'lik çözeltisi

- Film Oluşturan Lekelendiriciler

Zeytinyağı

Temizleme

- Temizleyici Maddeler

Sıcak su (55 ± 5 °C sıcaklıkta)

Zayıf temizleme maddesi

Güçlü temizleme maddesi

- Uygun Çözücüler

Hidroklorik asit çözeltisi, hacimce 3% (V/V)

Potasyum hidroksit çözeltisi, 200 g/l'lik

Aseton

Sınıflandırma

Sınıf 5 / Sınıf 4 / Sınıf 3 / Sınıf 2 / Sınıf 1

Sınıf 5 en yüksek lekelenmeye karşı direnci gösterir, bu da 1'e doğru gittikçe azalır.

Chemical Properties

1. Chemical Resistance, EN ISO 10545-13

Subjection of the test specimens to the action of the test solutions and visual determination of attack after a defined period.

Medium	Concentration
1 Aqueous test solutions	
1.1 Household chemicals / swimming pool additives	
Ammonium-chloride solution	100 g/l
Sodium hypochlorite solution	20 mg/l
Classification groups	A/B/C
1.2 Acids and alkalis	
1.2.1 Low concentrations (L)	
Hydrochloric acid	3%
Citric acid	100 g/l
Potassium hydroxide	30 g/l
Classification groups	LA/LB/LC
1.2.2 High concentrations (H)	
Hydrochloric acid	18%
Lactic acid	5%
Potassium hydroxide	100 g/l
Classification groups	HA/HB/HC

* Class A shows the highest resistance to chemicals, which decreases more and more towards C.

Number of specimens can be listed as;

Tile Maximum Area, A (cm ²)	Total Number of Tests Specimens (Tiles)
200 < A ≤ 3600	3
A > 3600	3
When A is ≤ 200 cm ² , the total number of test specimens (tiles) should be sufficient to cover an area of 200 cm ²	

2. Stain Resistance, EN ISO 10545-14

Determination of the resistance to stains by maintaining test solutions and materials in contact with the proper surface of the tiles for a suitable length of time; the surfaces are then subjected to defined cleaning methods, and finally inspected for visual changes.

Chemicals used in the test can be listed as;

- Stains leaving a trace

Green staining agent in light oil

Red staining agent in light oil

- Stains having chemical/oxidizing action

Iodine, 13g/l in alcohol

- Stain forming a film

Olive oil

Cleaning (within the framework of the test)

- Cleaning agent

Hot water (+55 °C)

Weak cleaning agent

Strong cleaning agent

- Solvent

Hydrochloric acid solution 3% (V/V)

Potassium hydroxide 200g/l

Acetone

Classes

Cl. 5 / Cl. 4 / Cl. 3 / Cl. 2 / Cl. 1

Class 5 shows the highest stain resistance, which decreases more and more towards 1.

Desen Farklılaşması

Karolar, belirli koleksiyonlar özelinde kendi içerisinde ürün tasarımına göre renk, doku veya görünüm olarak değişiklik gösterir. Özellikle desen farklılaşması V3, V4 tipi ürünler; kutular, numuneler, ticari ürünler ve gösterimler arasında önemli ölçüde değişiklik gösterebilir. Ürün seçimi sırasında desen farklılaşmasına dikkat etmeniz önerilir. VitrA karolarında, belirli ürünler için kataloglarda belirtilen beş desen farklılaşma sınıflandırması bulunmaktadır.

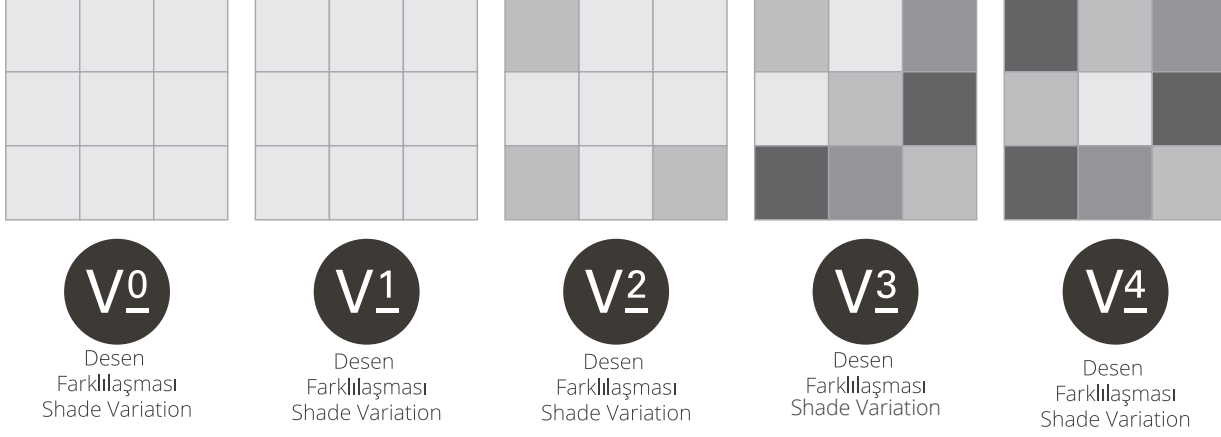

V₀-Tekdüze Görünüm

Karolar arasında önemsiz farklılıklarla her bir karo aynı renge, tona sahiptir.

V₁-Hafif Farklı Görünüm

Doğal bir etki için karonun kendi içinde ve karolar arasında küçük renk farklılıkları mevcuttur.

V₂-Farklı Görünüm

Benzer renklerde doku ve / veya desende gözle fark edilebilir farklılıklar mevcuttur.

V₃-Çok Farklı Görünüm

Karolar arasında ve/veya tek bir karo üzerindeki renk ve/veya doku farklılaşması önemli miktardadır.

V₄-Rastgele Farklı Görünüm

Karodan karoya renk ve/veya dokuda rastgele dağılım mevcuttur. Bu sebeple bir karo diğerinden tamamen farklı renk ve/veya dokuda olabilir. Sonuçta ürünlerin döşenmesi sonucu çıkan görünüm benzersiz olacaktır.

Shade Variation

Tiles may vary in colour, texture or appearance according to product design for particular tile collections. Especially Shade Variation V3, V4 type products may vary significantly within boxes, samples, merchandising and display. It is strongly recommended to pay attention to Shade Variation during product selection. VitrA has five groups with different variation intensity that are indicated on the catalogues for specific products.

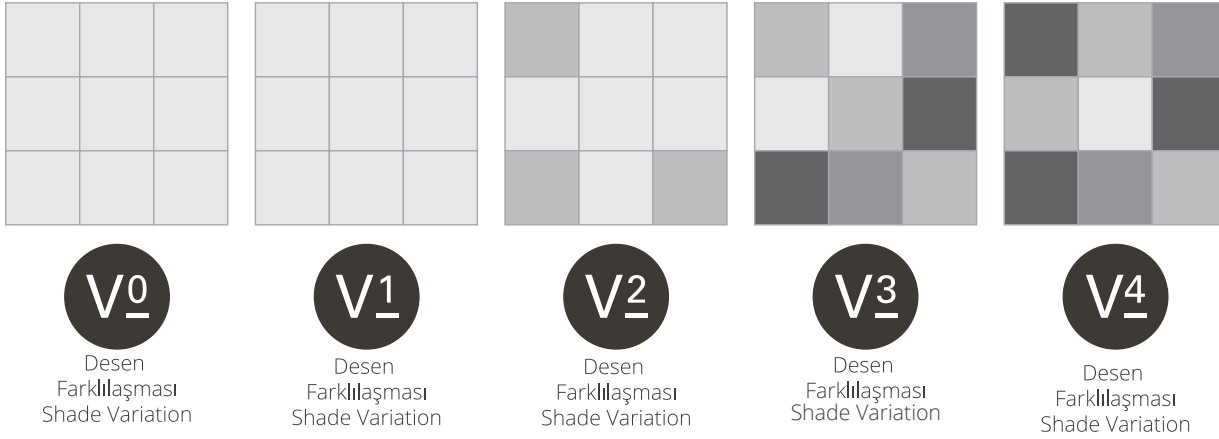

V0-Very Uniform Appearance

Pieces of the same shade value are very uniform and smooth in texture.

V1-Uniform Appearance

Minor variations in colour and structure for a restful, natural effect.

V2-Slight Variation

Clearly, distinguishable differences in texture and/or pattern within similar colors.

V3-Moderate Variation

While the color and/or texture on a single piece of tile could be indicative of the color and/or texture on the other tiles, the amount of color and/or texture variation on each piece may be significant.

V4-Substantial Variation

Random color and/or texture differences from tile to tile, so that one tile may have totally different color and/or texture from that on other tiles. Thus, the final installation will be unique.

1. Sürtünme Katsayısı/ Kayma Direnci

Kamuya açık alanlardaki kaymaya karşı dayanıklı karolar çıplak ayakla veya ayakkabıyla üzerinde yürünenler olarak ayırt edilmektedir. Su, yağ, çamur, makine yağı veya atık kullanımı nedeniyle risk olan yerlerde kaymaya karşı özel koruyucu tedbirler gereklidir. Bu durum yüzey materyali seçilirken dikkate alınmalıdır.

Döşenen karoların kaymaya karşı dayanıklılık değeri aşınma ve yüzey kirleri nedeniyle zaman içinde değişebilmektedir. Kaymaya karşı dayanıklılık değerlerinin korunması için düzenli temizlemenin yanında, derinlemesine temizlik ve çekiş artırıcı bakım periyodik olarak gerekebilecektir. (Ref: ANSI A137.1-2017)

Bir yüzeydeki kayma olasılığını etkileyebilecek olan pek çok faktör mevcuttur. Örnek olarak verilebilecekler: Ayakkabı tabanının malzemesi ve aşınma derecesi; yüzey kirlilerinin mevcut olması ve yapısı; kayma sırasındaki geçişin hızı ve uzunluğu; bir kayma sırasında bireyin fiziksel ve zihinsel durumu; zeminin düz mü yoksa eğimli mi olduğu; sert zemin döşeme malzemesinin nasıl kullanıldığı ve muhafaza edildiği ve malzemenin kayma dayanıklılık sınıflandırması, zemin yüzeyinin nasıl yapılandırıldığı ve sıvılar söz konusu olduğunda tahliyenin nasıl gerçekleştiği gibi faktörlerdir. Kayma riskinin oluşmasını etkileyebilecek pek çok değişken olduğundan, belirli bir uygulama için karonun kullanım uygunluğunun belirlenmesinde kayma dayanım sınıflandırması tek unsur olmayacaktır. (Ref: ANSI A326.3 Nisan 2017)

1.1. Endüstriyel Alanlarda Kayma Direnci

DIN 51130, yüksek kayma riski olan çalışma odaları ve çalışma alanlarındaki zemin kaplamalarının kayma direncini belirlemek için kullanılan test yöntemidir. Çalışma alanları kayma riskine göre beş değerlendirme grubu içerisinde sınıflandırılmıştır. Karoların endüstriyel kayma direnci için en düşük kaymazlık değeri R9 iken, en yüksek olanı R13'tür.

Endüstriyel alanların kayma direnci sınıflandırması ve dolma hacmi tablosunda, uygulama alanları "ASR 1.5/1,2 İşyerleri için Teknik Düzenlemeler"e göre belirlenmiştir.



$6^\circ < R9 < 10^\circ$

Düşük statik sürtünme / Low static friction



$10^\circ < R10 < 19^\circ$

Normal statik sürtünme / Normal static friction



$19^\circ < R11 < 27^\circ$

Yükseltilmiş statik sürtünme / Increased static friction



$27^\circ < R12 < 35^\circ$

Yüksek statik sürtünme / High static friction



$R13 > 35^\circ$

Çok yüksek statik sürtünme / Very high static friction

Açık alan testi / Open field test

Önemli Not: Belirtilen eğim açıları ürünün kaymazlık sınıflandırmasının belirlenmesine yardımcı olmaktadır ve eğim ve rampaların eğim açılarıyla ilişkilendirilemezler.

1. Coefficient of Friction/Slip Resistance

Slip-resistant coverings in publicly accessible areas are distinguished according to those that are walked over barefoot or in footwear. Special protective measures against slipping are necessary where there is a risk due to use of water, oil, slush, grease or waste. This should be taken into consideration when choosing the surface material.

The slip resistance value of installed tiles can change over time as a result of wear and surface contaminants. In addition to regular cleaning, deep cleaning and traction-enhancing maintenance may be needed periodically to maintain the slip resistance values. (Ref: ANSI A137.1-2017)

There are many factors that affect the possibility of a slip occurring on a surface including by way of example, but not in limitation, the following: the material of the shoe sole and the degree of its wear; the presence and nature of surface contaminants; the speed and length of stride at the time of a slip; the physical and mental condition of the individual at the time of a slip; whether the floor is flat or inclined; how the hard surface flooring material is used and maintained, and the slip resistance classification of the material, how the flooring surface is structured, and how drainage takes place if liquids are involved. Because many variables affect the risk of a slip occurring, the slip resistance classification shall not be the only factor in determining the appropriateness of a hard surface flooring material for a particular application. (Ref: ANSI A326.3 April 2017)

1.1. Slip Resistance Properties in Commercial Applications

DIN 51130 is the test method that is used for determining slip resistance of floor coverings in work rooms and work areas subject to higher risk of slipping. Working rooms and areas are classified according to five assessment groups on the basis of size and the risk of slipping. The lowest slip resistance value is R9 whereas the highest one is R13 for industrial slip resistance of tiles.

In table of industrial areas slip resistance classification and collection space, the application areas are indicated in accordance with "ASR 1.5/1.2 Technical Regulations for workplaces -Floors".



$6^\circ < R9 < 10^\circ$

Düşük statik sürtünme / Low static friction



$10^\circ < R10 < 19^\circ$

Normal statik sürtünme / Normal static friction



$19^\circ < R11 < 27^\circ$

Yükseltilmiş statik sürtünme / Increased static friction



$27^\circ < R12 < 35^\circ$

Yüksek statik sürtünme / High static friction



$R13 > 35^\circ$

Çok yüksek statik sürtünme / Very high static friction

Açık alan testi / Open field test

Important Notice: The indicated angles of inclination helps to identify anti-slip classification of the product and cannot be related to the angles of inclination of slopes/ramps.

VitrA Kayma Dayanımı

1.1.1. Kayma Riski Olan Çalışma Odaları ve Alanları (ASR A1.5/1.2'ye uygun olarak)

Özellikle çalışma alanlarındaki basma/basamak seviyesinin altındaki boşlukta dolma hacmine biriken ve kaymaya neden olan malzemelerin boşaltılması için dolma hacminin asgari hacmi bir "V" numarası ile tanımlanmaktadır.

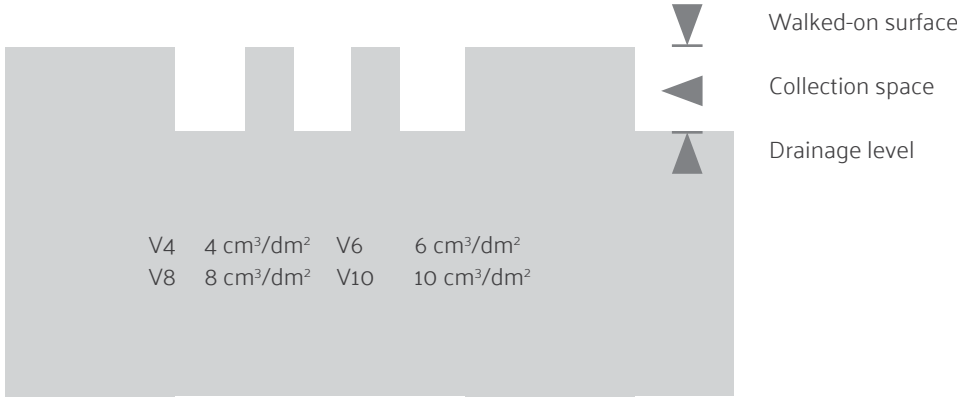

Yer değiştirme alanı (V4-V10) üzerinde yürünen üst dolaşım yüzeyi ile profilli yüzeylerin drenaj düzeyi arasındaki açıktır.

Endüstriyel Alanda Kayma Sınıfları Ve Dolma Hacmi - Kullanım Alanları - Asr 1.5/1.2'ye Uygun Olarak

Nr.	Çalışma alanları, yürüme yolları	Kayma sınıfı (R grupları)	En küçük dolma hacmi	Nr.	Çalışma alanları, yürüme yolları	Kayma sınıfı (R grupları)	En küçük dolma hacmi
0	Genel çalışma odaları			9.5	Yemek hazırlama mutfakları (fast-food, snack bar)	R 12	
0.1	Giriş yerleri (iç)	R 9		9.6	Dondurulmuş ürünlerin ısıtıldığı mutfaklar	R 12	V 4
0.2	Giriş yerleri (dış)	R 11 - R 10	V 4	9.7	Çay ve kahve hazırlama mutfakları, garni mutfağı, koğuş mutfağı	R10	V 4
0.3	Merdivenler (iç)	R 9		9.8	Bulaşık yıkama alanları	R10	
0.4	Merdivenler (dış)	R 11 - R 10	V 4	9.8.1	Bulaşık yıkama alanları 9.1, 9.4, 9.5 için	R 12	
0.5	Eğimli rampalar, iç (örn. tekerlekli sandalye, tesviye yokuşu, nakliye yolları için)	R10		9.8.2	Bulaşık yıkama alanları 9.2 için		
0.6	Sağlık odaları	R 9		9.8.3	Yemek odaları, misafir yemek odaları, servis bankosu olan kantinler	R 11	
0.6.1	Tuvaletler			9.9		R 12	V 4
0.6.2	Soyunma kabini veya yıkanma alanları			10	Soğuk hava ve donmuş gıda depoları	R 12	
0.7	Dinlenme odaları (örn. sosyal tesisler, kantinler)			10.1	Paketlenmiş malzemeler için	R 12	
0.8	İlk yardım odaları ve benzer tesisler			10.2	Paketlenmiş malzemeler için	R 9	
1	Margarin, yenilebilir sıvı ve katı yağ üretimi			11	Satış yerleri, dükkanlar	R 12	
1.1	Yağın eritilmesi	R 13	V 6	11.1	Et giriş	R 11	
1.2	Yemeklik yağ arıtımı	R 13	V 4	11.1.1	Paketlenmiş malzemeler için		
1.3	Margarin üretim ve paketlenme	R 12		11.1.2	Paketlenmiş malzemeler için		
1.4	Yemeklik yağ üretimi, paketlenme, işleme	R 12		11.2	Balık girişi	R 11	
2	Süt prosesi, peynir üretimi			11.3	Sosis, salam, sucuk ve et için servis geçişi	R 10	
2.1	Taze süt işlenmesi ve tereyağı üretimi	R 12		11.3.1	Paketlenmiş malzemeler için	R 11	
2.2	Peynir üretimi, depolama ve paketlenme	R 11		11.3.2	Paketlenmiş malzemeler için		
2.3	Dondurma üretimi	R 12		11.4	Paketlenmiş ekmek ve unlu mamuller için servis geçişi	R 11	
3	Çikolata ve şekerleme üretimi			11.5	Paketlenmiş süt ürünleri ve meze için servis geçişi	R 10	
3.1	Şekerin işlenmesi	R 12		11.6	Balık servisi	R 10	
3.2	Kakao üretimi	R 12		11.6.1	Paketlenmiş malzemeler için	R 10	
3.3	Ham kakaonun üretimleri	R 12		11.6.2	Paketlenmiş malzemeler için		
3.4	Çubuk, kabuk ve içi doldurulmuş çikolata üretimi	R 11		11.7	Nr. 11.3'ten 11.6'ya kadar hariç servis geçişleri	R 12	
4	Kek, pasta ve ekmek üretimi			11.8	Et hazırlama odaları	R 11	
4.1	(firınlar, pastaneler ve uzun dayanımlı unlu mamul üretimi)			11.8.1	Nr. 5 hariç işleme (düzeltme)	R 9	
4.2	Hamur hazırlama	R 11		11.8.2	Nr. 5 hariç işleme (işleme)		
4.3	Yağlı ve sıvı üretimin ağır bastığı yerler	R 12		11.9	Çiçek buketi yapım odaları	R 12	V 8
5	Et işleme, kesimhaneler (mezbah)			11.10	Sabit firmo olan satış bölgeleri	R 11	
5.1	Kesim yeri	R 13	V 10	11.10.1	Unlu mamullerin hazırlanması	R 11	
5.2	Sakatat temizleme yeri	R 13	V 10	11.10.2	Önceden hazırlanmış unlu mamullerin işlenmesi		
5.3	Et parçalama	R 13	V 8	11.11	Sabit fritözü ya da ızgarası olan satış bölgeleri	R 11	
5.4	Sosis, salam ve sucuk hazırlama	R 13	V 8	11.12	Satış yerleri ve müşteri kabul	R 10	
5.5	Haşlama bölümü	R 13	V 8	11.13	Self-servis yapan yerlerde yiyecek hazırlama bölümü	R 12	V 4
5.6	Ham üretim bölümü	R 13	V 6	11.14	Kasa ve paketlenme bölümleri	R 9	
5.7	Sucuk, salam, sosis kurutma odası	R 12		11.15	Açık alanda satış bölümleri	R 10	
5.8	Bağırşak deposu	R 12		12	Sağlık birimleri	R 9	
5.9	Tuzlama ve terbiye odası	R 12		12.1	Dezenfekte odaları (ıslak)	R 11 - R10	V 4
5.10	Kanattı işleme	R 12	V 6	12.2	Sterilizasyon için ön temizlik yerleri		
5.11	Soğuk kesim ve paketlenme	R 12		12.3	Dış atık odaları, temiz olmayan hemşirelik hizmetleri	R 11	
5.12	Elle işleme ve satış	R 12	V 8	12.4	Sektionsräume	R10	
6	Balık işleme ve meze üretimi			12.5	Tıbbi banyolar, hidroterapi üniteleri	R 10	
6.1	Balık işlenmesi	R 13	V 10	12.6	Ameliyathanelerin ve alçıların yıkanma odaları	R 10	
6.2	Meze üretimi	R 13	V 6	12.7	Tuvaletler, koğuş banyoları	R 11	
6.3	Mayonez üretimi	R 13	V 4	12.8	Masaj odaları, teşhis ve terapi odaları	R 10	
7	Sebzeye işlenmesi			12.9	Ameliyathaneler	R 10	
7.1	Sauerkraut üretimi	R 13	V 6	12.10	Hasta odaları ve koridorlar olan klinikler	R 9	
7.2	Konserve üretimi	R 13	V 6	12.11	Muayenehaneler, gündüz klinikleri	R 9	
7.3	Sterilizasyon odaları	R 11		12.12	Eczaneler	R 9	
7.4	Üretim için hazırlama	R 12	V 4	12.13	Laboratuvarlar	R 9	
8	Yemek ve içecek üretimindeki ıslak zeminler (özellikle farklı bir şey belirtilmemişse)			12.14	Kuaförler	R 9	
8.1	Kilerler, mahzenler	R 10		13	Çamaşırhaneler	R 9	
8.2	Meşrubat işleme ve meyve suyu üretimi	R 11		13.1	Kurutmalı (santrifüjü) çamaşır makineleri		
9	Mutfaklar ve pişirme yerleri			13.2	Çok ıslak çamaşırın olduğu yıkama odaları		
9.1	Restoran, otel mutfakları	R 11		13.3	Ütü ve çamaşır sıkma makinelerinin olduğu odalar	R 9	
9.2	Evlere, çocuk yuvalama, sanatoryumlara servis yapan mutfaklar	R 12	V 4	14	Konsantre hayvan yemi üretimi	R 11	
9.3	Hastane ve klinik mutfakları	R 11	V 4	14.1	Kurutulmuş yem üretimi	R 9	
9.4	Üniversite ve büyük fabrikalara servis veren mutfaklar	R 12		14.2	Su ve yağ kullanılarak kurutulmuş yem üretimi	R 9	V 4

Endüstriyel Alanda Kayma Sınıfları Ve Dolma Hacmi - Kullanım Alanları - Asr 1.5/1.2'ye Uygun Olarak

Nr.	Çalışma alanları, yürüme yolları	Kayma sınıfı (R grupları)	En küçük dolma hacmi	Nr.	Çalışma alanları, yürüme yolları	Kayma sınıfı (R grupları)	En küçük dolma hacmi
15	Deri üretimi, tekstil	R 11		25	Eysel atık işleme istasyonları	R 12	
15.1	Tabakhanedeki sulu yerler	R 11		25.1	Pompa odaları	R 11	V 4
15.2	Deri yüzme makinelerinin olduğu odalar			25.2	Sulu atıkların drenajı		
15.3	Deri parçalarının toplandığı odalar	R 13	V 10	25.3	Eleme odaları	R 12	
15.4	Derilerin empreye yapıldığı yerler	R 13	V 10	25.4	Ayakta durulan yerler ve bekleme odaları	R 12	
15.5	Tekstil için boya değirmenlerinin olduğu yerler	R 13		26	İtfaiye binaları	R 12	
16	Çila atölyeleri	R 12		26.1	Araç parkı	R 12	
16.1	Sulu öğütme atölyeleri	R 11		26.2	Hortum bakım atölyesi		
17	Seramik endüstrisi			27	Solunum cihazları eğitim tesisinde işlevsel odalar	R 12	
17.1	Islak değirmenler (seramik hammaddenin hazırlanması)	R 12		27.1	Hazırlık odası	R 12	
17.2	Karıştırıcılar, zift, grafit ve sentetik malzemelerin kullanıldığı yerler		V 10	27.2	Havalandırma odası		
17.3	Şekillendirme presleri zift, grafit ve sentetik malzemelerin kullanıldığı yerler	R 11		27.3	Eğitim odası	R 9	
17.4	Döküm / pres döküm alanları	R 11	V 6	27.4	Hava hücreсі		
17.5	Sırlama	R 11	V 6	27.5	Model ev		
18	Cam ve taş prosesi	R 12		27.6	Sıcak iklimli alıştırma odaları		
18.1	Taş kesme ve öğütme yeri	R 12		27.7	Denetim istasyonu		V 4
18.2	Her türlü cam şekillendirme alanı			28	Okullar ve kreşler		V 4
18.3	Öğütme yerleri	R 11		28.1	Sınıflar, grup odaları		
18.4	İzolasyon camı üretiminde kurutucu malzemelerin işlendiği yerler	R 11		28.2	Merdivenler		
18.5	Düz camın paketlenmesi ve yüklediği yerler, yapışmayı önleyici malzemelerin hazırladığı yerler	R 11	V 6	28.3	Tuvaletler, yıkama odaları	R 10	
18.6	Asitli indirme yapılan yerler	R 11	V 6	28.4	Okullardaki eğitimci mutfaklar (bkz. Nr. 9)	R 11 - R 10	
19	Prefabrik beton fabrikaları			28.5	Çocuk yuvalarındaki mutfaklar (bkz. Nr. 9)	R 11 - R 10	
19.1	Beton yıkama yerleri	R 11		28.6	Aşşap işleme makinelerinin olduğu odalar		
20	Depolar			28.7	El sanatları için özel odalar	R 9	
20.1	Likit ve katı yağlar için stok sahaları	R 11		28.8	Teneffüs alanları	R 9	
20.2	Paketlenmiş yiyeceklerin stok sahaları			29	Bankalar	R 9	
20.3	Açık alandaki stok sahaları	R 12		29.1	Banka vezneleri	R 10	V 4
21	Demir ve metalin kimyasal ve ısıtım işlem prosesi	R 10	V 6	30	Dış mekanlardaki işletmeyle ilgili yollar	R 10	
21.1	Beizeisen	R 11 - R 10		30.1	Yürüme yolları	R 10	V 4
21.2	Sertleştirme prosesi		V 4	30.2	Yükleme rampaları	R 10	
21.3	Laboratuvarlar	R 12		30.2.1	Örtülü	R 10	V 4
22	Metal prosesi, metal atölyeleri	R 12		30.2.2	Açık	R 11 - R 10	V 4
22.1	Galvanize atölyeleri	R 11		30.3	Eğik rampalar (örn. tekerlekli sandalyeler, yükleme köprüleri için)		
22.2	Graugussbearbeitung	R 11		30.4	Üstü kapalı	R 11 - R 10	
22.3	Mekanik proses (torna, pres yerleri) tel boru çekme yerleri, yağlı ortamdan dolayı riskin fazıalaştığı ortamlar	R 12	V 4	30.4.2	Üstü açık		
22.4	Parça temizleme yerleri, buhar çıkışının olduğu odalar	R 11	V 4	31	Park alanları	R 11 - R 10	
23	Araç bakım yerleri			31.1	Garajlar, hava koşullarından etkilenmeyen çok katlı ve yeraltı otoparkları	R 12	
23.1	Bakım ve servis alanı	R 12		31.2	Garajlar, hava koşullarından etkisinde kalan çok katlı ve yeraltı otoparkları	R 12	
23.2	Çalışma ve kontrol alanı			31.3	Açık park alanları	R 12	
23.3	Araç yıkama yerleri	R 11				R 11	
24	Uçak bakım atölyeleri	R 12	V 4				
24.1	Uçak hangarları	R 11	V 4				
24.2	Uçak bakım ve tamir hangarları						
24.3	Uçak yıkama yerleri	R 11					

VitrA Slip Resistance

1.1.1. Working Rooms and Areas with Risk of Slipping (in accordance with ASR A1.5/1,2)

DIN 51130 is the test method that is used for determining slip resistance of floor coverings in work rooms and work areas subject to higher risk of slipping. Working rooms and areas are classified according to five assessment groups on the basis of size and the risk of slipping. The lowest slip resistance value is R9 whereas the highest one is R13 for industrial slip resistance of tiles.

In table of industrial areas slip resistance classification and collection space, the application areas are indicated in accordance with "ASR 1.5/1,2 Technical Regulations for workplaces –Floors".

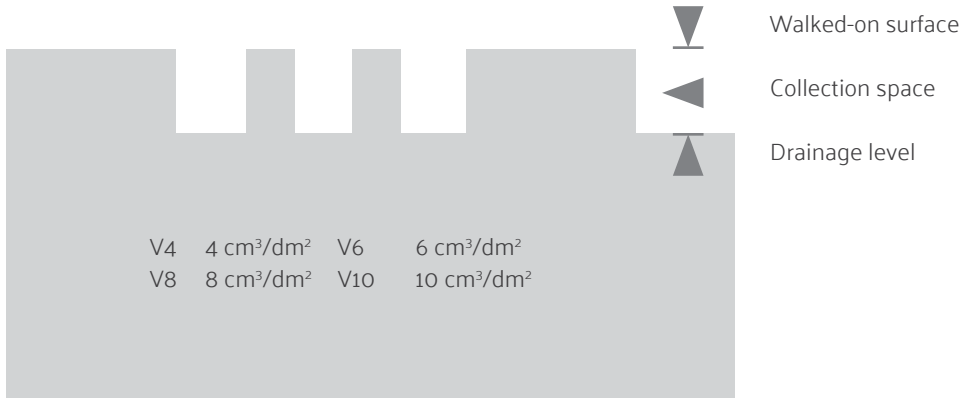

The displacement space (V4-V10) is the open space between the upper walked-on surface and the drainage level of profiled surfaces.

Industrial Areas Slip Resistance Classification and Collection Space - Application Areas

Nr.	Working areas, walking corridors	Antislip groups (R classes)	Minimum collection space	Nr.	Working areas, walking corridors	Antislip groups (R classes)	Minimum collection space
0	General working rooms and areas			9.5	Food preparation kitchens (fast-food kitchens, snack bars)	R 12	V 4
0.1	Entrance areas (inside)	R 9		9.6	Kitchens for heating up frozen meals	R 10	
0.2	Entrance areas (outside)	R 11 - R 10	V 4	9.7	Coffee and tea kitchens, hotel garni kitchens and ward kitchens	R 10	
0.3	Stairs (inside)	R 9		9.8	Washing-up areas	R 12	V 4
0.4	Stairs (outside)	R 11 - R 10	V 4	9.8.1	Washing-up areas for 9.1, 9.4, 9.5	R 11	
0.5	Sloping ramps, inside* (eg. for wheelchairs, leveling slopes, transport paths)	R 10		9.8.2	Washing-up areas for 9.2	R 12	
0.6	Sanitary rooms	R 9		9.8.3	Washing-up areas for 9.3	R 12	
0.6.1	Toilets			9.9	Dining rooms, guest rooms, canteens including serving counters	R 9	
0.6.2	Changing or washrooms			10	Cold stores, deep freeze stores		
0.7	Break rooms (eg. dayrooms, canteens)			10.1	For unpacked goods	R 12	
0.8	First aid rooms and similar facilities (see ASR A4.3)			10.2	For packed goods	R 11	
1	Manufacture of margarine, edible fats and oils			11	Sales outlets, shops		
1.1	Melting of fat	R 13	V 6	11.1	Reception of goods, meats		
1.2	Cooking oil refinery	R 13	V 4	11.1.1	For unpacked goods	R 11	
1.3	Margarine production and packaging	R 12		11.1.2	For packed goods	R 10	
1.4	Cooking fat production and packing, oil bottling	R 12		11.2	Reception of goods, fish	R 11	
2	Milk processing, cheese production			11.3	Serving counters for meat and sausage		
2.1	Fresh milk processing and butter production	R 12		11.3.1	For unpacked goods	R 11	
2.2	Cheese production, storage and packaging	R 11		11.3.2	For packed goods	R 10	
2.3	Icecream manufacturing	R 12		11.4	Serving counters for bread, cakes and pastries, unpacked goods	R 10	
3	Chocolate and confectionery production			11.5	Serving counters for cheese and cheese products, unpacked goods	R 10	
3.1	Sugar processing	R 12		11.6	Serving counters for fish		
3.2	Cocoa production	R 12		11.6.1	For unpacked goods	R 12	
3.3	Production of raw mixtures	R 11		11.6.2	For packed goods	R 11	
3.4	Fabrication of chocolate bars, shells and filled chocolates	R 11		11.7	Serving counters from Nr.11.3 to 11.6	R 9	
4	Production of bread, cakes and pastries (bakeries, cake shops, production of long-life bakery products)			11.8	Meat preparation rooms		
4.1	Dough production	R 11		11.8.1	For meat preparation, except for no.5	R 12	V 8
4.2	Rooms in which predominantly fats or liquid mixtures are processed	R 12		11.8.2	For meat preparation, except for no.5	R 11	
4.3	Washing-up rooms	R 12	V 4	11.9	Florists shops	R 11	
5	Slaughtering, meat processing			11.10	Sales areas with stationary ovens		
5.1	Slaughter house	R 13	V 10	11.10.1	For the production of bread, cakes and pastries	R 11	
5.2	Tripe processing room	R 13	V 10	11.10.2	For the warming-up of refabricated bread, cakes and pastries	R 10	
5.3	Meat sectioning	R 13	V 8	11.11	Sales areas with stationary chip pans or grills	R 12	V 4
5.4	Sausage kitchen	R 13	V 8	11.12	Shops, customer rooms	R 9	
5.5	Boiled sausage unit	R 13	V 8	11.13	Preparation areas for food and self-service shops	R 10	
5.6	Raw sausage unit	R 13	V 6	11.14	Cash register areas, packing areas	R 9	
5.7	Sausage drying room	R 12		11.15	Outdoor sales areas	R 11 - R 10	V 4
5.8	Smoking establishments	R 12		12	Health service rooms		
5.9	Salting and curing rooms	R 12		12.1	Disinfection rooms (wet)	R 11	
5.10	Poultry processing	R 12	V 6	12.2	Pre-cleaning areas of sterilization	R 10	
5.11	Gut store	R 12		12.3	Faeces disposal rooms, discharge rooms, unclean nursing work rooms	R 10	
5.12	Cold cuts and packaging unit	R 12	V 8	12.4	Pathological facilities	R 10	
6	Fish processing, production of delicatessen			12.5	Rooms for medical baths, hydrotherapy, fango preparation	R 11	
6.1	Fish processing	R 13	V 10	12.6	Washrooms of operating theatres, plastering rooms	R 10	
6.2	Production of delicatessen	R 13	V 6	12.7	Sanitary rooms, ward bathrooms	R 10	
6.3	Manufacture of mayonnaise	R 13	V 4	12.8	Rooms for medical diagnosis and therapy, massage rooms	R 9	
7	Processing of vegetables			12.9	Operation theatres	R 9	
7.1	Production of sauerkraut	R 13	V 6	12.10	Wards with hospital rooms and corridors	R 9	
7.2	Vegetable tinning	R 13	V 6	12.11	Medical practices, day clinics	R 9	
7.3	Sterilization rooms	R 11		12.12	Pharmacies	R 9	
7.4	Rooms in which vegetables are prepared for processing	R 12	V 4	12.13	Laboratories	R 9	
8	Food areas in food and beverage production (if not specifically mentioned)			12.14	Hairdressing salons		
8.1	Storage cellars	R 10		13	Laundries		
8.2	Beverage bottling, fruit juice production	R 11		13.1	Rooms with continuous-flow washing machines	R 9	
9	Catering establishments			13.2	Rooms with washing machines or with spin-drier	R 11	
9.1	Kitchens in the catering trade (restaurant kitchens, hotel kitchens)			13.3	Ironing rooms	R 9	
9.1.1	Up to 100 meals per day	R 11	V 4	14	Fodder concentrate production		
9.1.2	More than 100 meals per day	R 12	V 4	14.1	Dried fodder production	R 11	
9.2	Catering kitchens serving to homes, schools, kindergartens, sanatoria	R 11		14.2	Fodder concentrate production using fat and water	R 11	V 4
9.3	Kitchens of hospitals and clinics	R 12					
9.4	Catering kitchens serving to universities and industrial canteens	R 12	V 4				

Industrial Areas Slip Resistance Classification and Collection Space - Application Areas

Nr.	Working areas, walking corridors	Antislip groups (R classes)	Minimum collection space	Nr.	Working areas, walking corridors	Antislip groups (R classes)	Minimum collection space
15	Leather productions, textiles			24.3	Washing halls	R 12	
15.1	Wet areas in tanneries	R 13		25	Sewage treatment plants	R 11	V 4
15.2	Rooms with fleshing machines	R 13		25.1	Pump rooms		
15.3	Areas where leather scraps accumulate	R 13	V 10	25.2	Rooms for sludge draining facilities	R 12	
15.4	Rooms for making leather impermeable by means of grease	R 12	V 10	25.3	Rooms for screening equipment	R 12	
15.5	Dye mills for textures	R 11		25.4	Stands of workplaces, scaffolds and maintenance platforms	R 12	
16	Paint shops			26	Fire brigade buildings	R 12	
16.1	Wet grinding areas	R 12		26.1	Vehicle parking places		
17	Ceramic industry		V 10	26.2	Rooms for hose maintenance equipment	R 12	
17.1	Wet grinding mills (processing of ceramic, raw materials)	R 11		27	Functional rooms in the breathing apparatus training facility	R 12	
17.2	Mixers; handling of materials like tar, pitch, graphite and synthetic resins	R 11		27.1	Preparation room		
17.3	Presses (shaping); handling of materials like tar, pitch, graphite and synthetic resins	R 11	V 6	27.2	Conditioning room		
17.4	Casting / die casting areas	R 12	V 6	27.3	Training room		
17.5	Glazing areas	R 12		27.4	Air lock		
18	Glass and stone processing			27.5	Mock-up dwelling		
18.1	Stone cutting, stone grinding	R 11		27.6	Heat acclimatization room		
18.2	Glass moulding of hollow glass, container glass, structural glass	R 11		27.7	Control station		
18.3	Grinding areas for hollow glass ware, flat glass	R 11		28	Schools and day nurseries	R 9	
18.4	Insulating glass manufacture; handling of drying agents	R 11		28.1	Class rooms, group rooms		
18.5	Packaging, shipping of flat glass; handling of anti-adhesive agents	R 11	V 6	28.2	Stairs	R 10	
18.6	Etching and acid polishing facilities for glass	R 11	V 6	28.3	Toilets, washrooms	R 11 - R 10	V 4
19	Cast concrete factories			28.4	Instructional kitchens in schools (also see no.9)	R 11 - R 10	V 4
19.1	Concrete washing areas	R 11		28.5	Kitchens in kindergartens (also see no.9)		
20	Storage rooms			28.6	Machine rooms for wood processing	R 9	
20.1	Storage areas for oils and fats	R 12		28.7	Special rooms for handicrafts	R 9	
20.2	Storage areas for packed food	R 10	V 6	28.8	Schoolyards	R 9	
20.3	Outdoor storage areas	R 11 - R 10		29	Banks	R 10	
21	Chemical and thermal treatment of iron and metal		V 4	29.1	Bank counter	R 10	
21.1	Pickling plants	R 12		30	Plant traffic routes in outdoor areas	R 10	
21.2	Hardening shops	R 12		30.1	Footpaths	R 10	
21.3	Laboratory rooms	R 11		30.2	Loading platforms	R 10	
22	Metal processing, metal workshops			30.2.1	Covered	R 11 - R 10	V 4
22.1	Galvanizing shops	R 12		30.2.2	Not covered		
22.2	Grey cast iron processing	R 11		30.3	Sloping ramps (e.g. for wheel-chairs, loading platforms)	R 11 - R 10	V 4
22.3	Mechanical processing areas (turnery, milling shop), punching room, pressroom, drawing shop (pipes, wires) and areas exposed to increased stress by oil and lubricants	R 11	V 4	30.4.1	Covered		
			V 4	30.4.2	Not covered	R 11 - R 10	V 4
22.4	Parts cleaning areas, exhaust steam areas			31	Parking areas	R 12	V 4
23	Vehicle repair workshops			31.1	Garages, multi-storey and underground car parks not subject to the effects of the weather	R 12	
23.1	Repair and servicing bays	R 12		31.2	Garages, multi-storey and underground car parks subject to the effects of the weather	R 12	
23.2	Working and inspection pits	R 11		31.3	Parking areas outdoors	R 11	
23.3	Car washing halls, washing areas	R 12	V 4				
24	Aircraft repair workshops		V 4				
24.1	Aircraft hangars	R 11					
24.2	Repair hangars	R 11					

VitrA Kayma Dayanımı

1.2. Çıplak Ayaklı Alanlardaki Kayma Dayanım Özellikleri

DIN 51097, kayma riski olan ıslak çıplak ayaklı alanlardaki zemin kaplamalarının kayma dayanımının belirlenmesi için kullanılan test yöntemidir. DIN 51097'ye göre, ıslak çıplak ayaklı alanlarda kayma riskine göre üç değerlendirme grubu bulunmaktadır. Karoların çıplak ayaklı kayma dayanımı sınıflandırması için en düşük kayma dayanım değeri A iken en yüksek olanı C'dir.

Çıplak ayaklı alanların kayma dayanım sınıflandırması ile ilgili aşağıdaki tabloda, uygulama alanları "DGUV Bilgileri 207-006 – Islak çıplak ayak alanlar için zemin kaplamaları" kitapçığına göre belirlenmiştir.

Wet barefoot areas slip resistance classification and application areas

Class	Min. degree of slope	Areas
A	12°	<ul style="list-style-type: none">- Çıplak ayaklı geçişler ve sıhhi bölgeler (esas kuru olarak)- Bireysel ve ortak giyinme odaları- Eğer su derinliği tüm alanda 80 cm'den fazlaysa, yüzücüler için olmayan alanlardaki havuz zeminleri- Sauna ve rahatlama alanları (esas olarak kuru olanlar)
B	18°	<ul style="list-style-type: none">- Eğer grup A içinde sınıflandırılmamışsa çıplak alan geçişleri ve sıhhi alanlar- Duşlar- Buhar banyoları- Dezenfektan sprey imkanları alanı- Havuz çevreleri- Belirli alanlarda su derinliği 80 cm'den azsa yüzücülerin olmadığı alandaki havuz zeminleri- Dalga hareketli havuzlarda yüzücüler için olmayan alanlar- Hareket edebilen zeminler- Çocuk havuzları- Eğer C grubu içinde sınıflandırılmamışsa havuz alanı dışındaki merdivenler ve basamaklar- Eğer C grubu içinde sınıflandırılmamışsa dalış platformları ve dalış tahtalarının erişilebilir yüzeyleri- Eğer A grubu içinde sınıflandırılmamışsa sauna ve rahatlama alanları
C	24°	<ul style="list-style-type: none">- Suya gidiş merdivenleri ve basamakları- Dalış alanlarına ve su kaydıraklarına giden merdiven basamakları- Dalıcı için ayrılan uzunluk üzerindeki dalış platformlarının ve dalış tahtalarının yüzeyleri (Dalış platformlarının ve dalış tahtalarının kaymaya dayanıklı yüzeyleri dalıcıların ellerinin ve ayak parmaklarının kavradığı ön kısmı kaplamalıdır.)- İçinden yürünebilen havuzlar- Eğimli havuz kenar tasarımları- Kneipp havuzları, su basamak havuzları- Havuzdaki rampalar alanı > 6 % eğimi ile çevrelemektedir.

Önemli Not: Belirlenen eğim açıları ürünün kaymazlık sınıflandırmasını tanımlamaya yardımcı olurlar ve bunlar eğimlerin / rampaların eğim açıları ile ilişkilendirilemezler.

VitrA Slip Resistance

1.2. Slip-Resistance Properties in Barefoot Areas

DIN 51097 is the test method that is used for determining slip resistance of floor coverings in wet barefoot areas subject to risk of slipping. According to DIN 51097, there are three assessment groups on the basis of size and the risk of slipping in wet barefoot areas. The lowest slip resistance value is A, whereas the highest one is C for classification of barefoot slip resistance of tiles. In the following table of barefoot areas slip resistance classification, the application areas are indicated in accordance with the leaflet "DGUV Information 207-006 - Floor coverings for wet barefoot areas".

Wet barefoot areas slip resistance classification and application areas

Class	Min. degree of slope	Areas
A	12°	<ul style="list-style-type: none">- Barefoot passages and sanitary areas (mainly dry)- Individual and common dressing rooms- Pool floors in non-swimmer areas if the water depth is more than 80 cm in the entire area- Sauna and relaxation areas (mainly dry)
B	18°	<ul style="list-style-type: none">- Barefoot passages and sanitary areas, if not classified in group A- Showers- Steam baths- Area of disinfecting spray facilities- Pool surrounds- Pool floors in non-swimmer areas if the water depth is less than 80 cm in certain areas- Non-swimmer sections of wave-action pools- Movable floors- Paddling pools- Ladders and stairs outside the pool area, if not classified in group C- Accessible surfaces of diving platforms and diving boards, if not classified in group C- Sauna and relaxation areas, if not classified in group A
C	24°	<ul style="list-style-type: none">- Ladders and stairs leading into the water- Stairs up to diving facilities and water slides- Surfaces of diving platforms and diving boards over the length reserved for the diver (the slip-resistant surface of the diving platforms and diving boards must cover the front edge where the hands and the toes of the divers grip)- Walk-through pools- Inclined pool edge designs- Kneipp pools, water-treading pools- Ramps in the pool surround area with an inclination > 6 %

Important Notice: The indicated angles of inclination helps to identify anti-slip classification of the product and cannot be related to the angles of inclination of slopes/ramps.

VitrA Kayma Dayanımı

2. Pendulum

Pendulum CoF testi (Ayrıca taşınabilen kayma direnci test cihazı, İngiliz pendulumu ve TRRL pendulumu olarak da adlandırılmıştır) bir İngiliz Standardı olan BS 7976: 1-3 kısımları, 2002'ye tabidir.

Four-S kauçuğu olarak da bilinen Slider 96 kauçuğu kullanılarak pendulumdan elde edilen bilgiler (Standart simüle edilen ayakkabı tabanı) ortamların çoğunda kayganlığın değerlendirilmesi için yeterlidir. Fakat çıplak ayaklı alanların değerlendirilmesinde, alışılmadık şekilde pürüzlü veya profilli olan zeminlerde TRRL kauçuğu olarak da bilinen Slider 55 kauçuğun kullanımı avantajlı olabilecektir (benzer ama daha yumuşak olan daha şekil verilebilir bir bileşen).

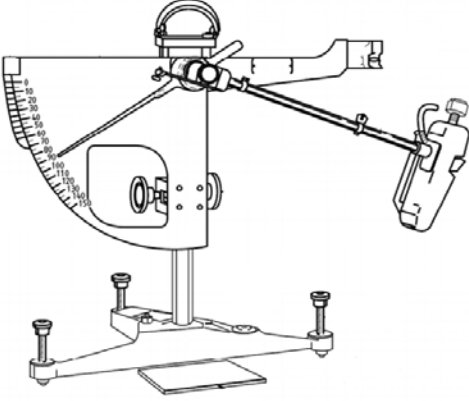

Pendulum CoF Testi (BS 7976-1:2002 Pendulum test cihazlarından uyarlanan diyagram - 1.Kısım: Özellikler)

(PTV) (UKSRG, 2011'den) Pendulum test değerlerine dayalı olarak kayma potansiyeli sınıflandırması

	PTV
Yüksek Kayma Potansiyeli	0-24
Orta Düzeyde Kayma Potansiyeli	25-35
Düşük Düzeyde Kayma Potansiyeli	36 +

3. DCOF

DCOF, hareket halinde olan bir yüzeyin üzerinde bulunan yüzey üzerinden kayması için gereken gücün bir nesnenin ağırlığına (veya normal güç) bölünmesi ile elde edilen orandır. Bu güç iki yüzeyin maddesel özelliğidir. Kir, su, sabun, yağ veya motor yağı gibi kontaminasyonlar bu değeri değiştirebilirler. Test ANSI A137.1 ve ANSI A326.3 standartlarına göre yapılmaktadır.

Aksi belirtilmedikçe, yüzeyler ıslak olduklarında üzerinde yürünmeye uygun olan karolar SLS çözümü ile test edildiklerinden 0,42 veya daha büyük ıslaklık DCOF değerine sahip olacaklardır. Fakat DCOF değeri 0,42 veya üzerinde olan karoların tüm projeler için uygun olduğunu belirtmek mümkün değildir. Belli proje koşulları için uygun olan karolar, karo seçimini gerçekleştirirken belirlenmelidir. Örnek olarak kullanım çeşidi, trafik, beklenen kirlendiriciler, beklenen bakım, beklenen aşınma ve üreticilerin tavsiyeleri ve kılavuzları dikkate alınmalıdır. (Ref: ANSI A137.1-2017)

VitrA Karo Ebat Bilgileri

Karo boyutu, çalışma boyutu ve önerilen derz aralığı ile hesaplanan anma boyutu olarak ifade edilir. Kutu içindeki miktar, kutu etiketinde metrekare olarak basılır ve uygun derz aralığı ile döşenmesinden elde edilen anma boyutundan hesaplanır.

Endüstriyel karo üretiminde, karoların boyutlarındaki (kalibre) farklılıklar, rektifiye olmayan karolar için kaçınılmazdır. Boyutlar kalibrelerine göre ayrı ayrı sıralanır, etiketlenir ve kutulanır. Kalibre numarası her kutu etiketinde basılıdır ve aşağıdaki örnekte olduğu gibi karonun gerçek boyutunu ifade eder:



Kutu Üzeri Etiket



Kutu Üzeri Bilgi

* Gösterilen etiketler sadece bilgi amaçlıdır ve etiketlerin içeriği bağlayıcı değildir.

VitrA Slip Resistance

2. Pendulum

The pendulum CoF test (also known as the portable skid resistance tester, the British pendulum, and the TRRL pendulum) is the subject of a British Standard, BS 7976: Parts 1-3, 2002.

Information generated by the pendulum using Slider 96 rubber, also known as Four-S rubber (Standard Simulated Shoe Sole) is sufficient for assessing slipperiness in most circumstances. However, for assessing barefoot areas, unusually rough or profiled floors, the use of Slider 55 rubber, also known as TRRL rubber (a similar but softer, more malleable compound) may be advantageous.

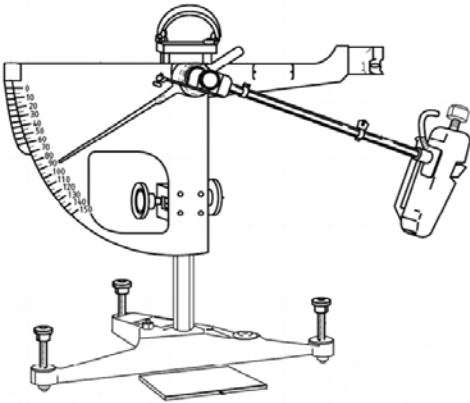

Pendulum CoF Test (Diagram adapted from BS 7976-1:2002 Pendulum testers - Part 1: Specification)

Slip Potential Classification, based on pendulum test values (PTV) (from UKSRG, 2011)	
	PTV
High Slip Potential	0-24
Moderate Slip Potential	25-35
Low Slip Potential	36 +

3. DCOF

DCOF is the ratio of the force necessary to keep a surface already in motion sliding over another divided by the weight (or normal force) of an object. This force is a materials property of the two surfaces. Contaminants such as dirt, water, soap, oil or grease can change this value. The test is done according to standards of ANSI A137.1 and ANSI A326.3.

Unless otherwise specified, tiles suitable for level interior spaces expected to be walked upon when wet shall have a wet DCOF of 0,42 or greater when tested using SLS solution. However, tiles with a DCOF of 0,42 or greater are not necessarily suitable for all projects. The specifier shall determine tiles appropriate for specific project conditions, considering by way of example, but not in limitation, type of use, traffic, expected contaminants, expected maintenance, expected wear and manufacturers' guidelines and recommendations. (Ref: ANSI A137.1-2017)

VitrA Tile Size Information

The tile format is given as a nominal dimension, which is calculated by the work size (aspired manufacturing size) plus the recommended joint width. The content within the box is printed as square-meter on box label and is calculated from the nominal size which is achieved with the use of appropriate joint width.

In the industrial manufacture of tiles, variations in the size (calibre) of the tiles are inevitable for non-rectified tiles. The sizes are sorted, labelled and boxed separately. The calibre code is printed on each box label and specifies the actual size of the tile as below:

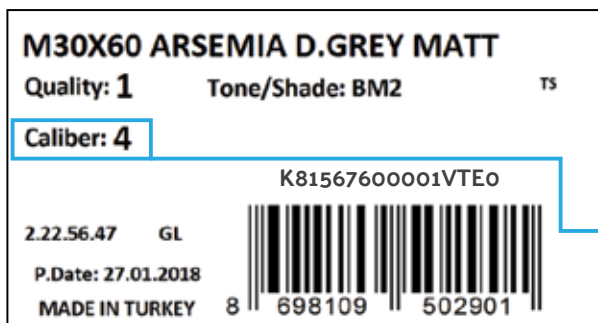

Label on the box



Information on the box

*The labels shown are for information only and the contents of the labels are not binding.

VitrA Temizlik ve Bakım Talimatları

1.Genel Bilgiler

VitrA karolar, en gelişmiş ekipmanlar kullanılarak, kapsamlı ve sıkı önlemler ile takip edilen proses kontrolleri altında üretilmektedir. Piyasadaki en iyi hammaddelerin tedarik edilmesiyle kalite, güvence altına alınmıştır. VitrA, sürekli olarak kaliteye olan bağlılığını sürdürmeye odaklanmakta, böylece ürünlerimiz beklentilerinizi karşılamakta ve beklentilerinizin ötesine geçmektedir.

Pazar araştırma çalışmaları ve testler, seramiklerin diğer kaplama malzemelerine kıyasla mükemmel özellikler sergilediğini kanıtlamaktadır. Uzun ömürlü görsel güzelliği, temizlik kolaylığı ve yüksek işlevsellik, seramik karoları hem özel (kişisel kullanım) hem de kamusal alanlarda en çok tercih edilen yüzey döşeme malzemesi yapan şeydir. Tüm sırlı ve sırsız karolar, kolay temizlik için ideal yüzey özellikleri ile ayırt edicidir. Her kaplama malzemesinde olduğu gibi, ürünlerimiz yıllarca tatmin edici temiz bir görünüm sağlamak için bakım gerektirir. Sürdürülebilirliğe önem veren bir şirket olarak VitrA, karo ve derzlerin temizlenmesi ve bakımı için düşük VOC, tehlikeli olmayan ve kirlenmeyi önleyen ürünlerin kullanılmasını önermektedir.

Düzenli temizlik: kirlilik derecesine ve kullanım sıklığına bağlı olarak ihtiyaçlara göre planlanmalıdır: günde birkaç kez veya günde bir kez veya haftada bir kez olabilir. Kamusal alanlardaki kullanımı için, ayakkabılardaki kirin binanın girişinin önünde bulunan çamurluk, paspaslar ve temizleme bölgeleri ile dışarıda kalması sağlanmalıdır. VitrA, temizlik maddelerinin kullanımını ve çevreye olan etkiyi en aza indirmek amacıyla bu tür kirlenmeyi önleyici öğelerin uygun şekilde seçilmesini önermektedir.

Döşmeden önce, seçilen derz renginden bağımsız olarak, her zaman, harç veya harç pigmentinin karo yüzeyini etkileyip etkilemeyeceğini belirlemek için küçük bir alan test edilmelidir.

1.1. Döşeme-İnşaat Sırasında Bakım

VitrA ürünleri son kaplama malzemesi olarak kabul edildiğinden, tüm ağır işler bitene kadar döşenmemelidir. İnşaat kaynaklı temizlik sorunlarından kaçınmak için döşenen alan kullanıma açık hale gelene kadar döşenen alandaki karoları ve derz dolgularını uygun bir şekilde korumak gereklidir. Her şantiyede kir ve kalıntı birikir ve bu biriken kirler/kalıntılar, derzin ve bazen de karoların olumsuz etkilenmesine neden olabilir. VitrA, bu durumu önlemek ve döşendikten sonraki görünümü korumak için döşeme alanı üzerine koruyucu bir malzeme serilmesini önerir. Bu sayede döşenmiş alanın kalitesi kullanıma hazır oluncaya kadar korunacaktır. Koruyucu malzeme olarak mukavva, karton, kontrplak veya döşemenin bütünlüğüne zarar vermeyecek herhangi temiz ve yumuşak bir malzeme kullanılabilir. Derzlerin düzgün bir şekilde kuruyup sertleşmesine izin vermeyeceği ve inşaat tozunun üzerine yapışarak kaygan bir alan oluşturabileceği için plastik korumalar kullanılmamalıdır.

1.2. Uygun Malzeme Seçimi ve Temizleme Maddesi Kullanımı

Sadece önerilen miktarda seyreltilmiş deterjan kullanılmalıdır. Unutulmamalıdır ki temizlik malzemelerinin fazlası her zaman için iyi değildir; temizleme çözeltilisinde daha yüksek deterjan konsantrasyonları kullanmak durulamayı zorlaştıracaktır. Bununla birlikte, suyun sertliğinin artması daha fazla temizlik maddelerinin kullanılmasına neden olur. Herhangi bir temizlik maddesini kullanırken, lütfen temizlik maddesi üreticisinin kullanım ve tehlike göstergelerine uygun olarak kullanıldığından emin olun. VitrA, temizlik maddesi üreticileri tarafından verilen talimatlara ve bilgilere uyulmamasından kaynaklanan hasarlar için herhangi bir sorumluluk kabul etmemektedir. Kirliliğe etki etmesi için temizlik maddeleri kirliliği artırabilir. Genellikle 5-10 dakika yeterlidir. Kirliliği temizlemek için temiz su ile bölgeyi iyice durulayın. Durulama, bakım prosedüründe kritik bir adımdır. Durulama için kullanılan suyu yerden vakumla, kuru paspasla veya bezle temizleyin. Kirliliği gideren deterjan solüsyonu durulanmazsa ve yüzeyde kurumaya bırakılırsa, yüzey üzerinde çirkinleşmesi çok zor olan bir kaplama oluşacaktır.

1.2.1. Temizlik Maddelerinin Uygun Seçimi ve Kullanımı İçin Uyarılar:

- 1) VitrA karolar, hidroflorik asitler veya florür tuzları ve türevleri içeren bileşikler dışında, EN ISO 10545-13'te tanımlanan hem asidik hem de alkali kimyasallara dayanıklıdır. Hidroflorik asit, bol su ile seyreltildiğinde bile, moleküler yapıları nedeniyle karolara zarar veren tek örnektir. Herhangi bir malzeme döküldüğünde mümkün olduğunca çabuk temizlenmelidir.
- 2) Karolar üzerinde görsel, hijyenik, kayma dayanımı ve temizleme özelliklerini olumsuz etkileyecek, yapışkan yağlı, mumsu ve sentetik tabakalar oluşturacak bir temizlik maddesi kullanmayın. Seçilen temizlik maddesi aynı zamanda harçla da uyumlu olmalıdır. Her zaman kullanım öncesi seçilen temizlik maddesiyle küçük bir alan test edilmelidir.

1.3.Genel Temizlik Talimatları

Temizlik prosedürü için aşağıdaki kurallara uyulmalıdır:

1. Uygun temizlik maddesi seçilmelidir.
2. Toz veya kalıntıları temizlemek için temizlikten önce zemin süpürülmelidir.
3. Temizlik maddesi kir üzerine temas etmesi ve yok etmesi için yeterli süre üzerinde bekletilmelidir.
4. Mekanik bir fırçalama işlemi veya silme işlemi yapılmalıdır.
5. Karolardan çıkan kirler toplanmalı, yıkanmalı veya vakumlanmalıdır.
6. Temizleme işlemi bittiğinde su ile durulanmalıdır.
7. Durulama suyu ıslak bir vakum, kuru paspas veya bez ile alınmalıdır.

Yukarıda bahsi geçen prosedür içeriği genel önerileri kapsamaktadır. Bireysel üreticiler tarafından önerilen temizlik maddeleri, derz, derz temizleyiciler vb. özel tavsiyeler uygulanmalıdır.

VitrA Cleaning and Care Instructions

1. General Information

VitrA Tiles are produced utilizing the most advanced equipment under extensive and strict process controls. Quality is assured with sourcing the finest raw materials available in the market. VitrA continuously focuses on maintaining its commitment to quality so that our products meet and exceed your expectations.

Market research studies and tests prove that ceramic displays excellent properties compared to other covering materials. Its long lasting beauty, ease of cleaning and high functionality are what makes ceramic tiles the most chosen covering material in both private and public areas. All glazed and unglazed materials are distinguished by surfaces which are ideal for easy cleaning. As with every covering material, our products require nominal care in order to maintain a satisfactory appearance and acceptable sanitation for years.

As a company committed to sustainability, VitrA recommends the use of low VOC, non-hazardous, and non-polluting products for cleaning and maintaining tiles and grout.

Regular cleaning has to be planned according to the needs, depending on the degree of soiling and frequency of use: could be several times a day or once a day or once a week. For public use, shoe-scrappers, doormats and cleaning zones for shoes in front of the entrance of the building ensure that most dirt is left outside. VitrA recommends proper selection of such preventive elements for the sake of minimizing the use of cleaning agents and impact on environment. Before grouting, regardless of the grout colour chosen, always test a small area first to determine if the grout or grout pigment will affect the surface of the tile.

1.1 Proper Care During Construction

Since VitrA products are considered to be a finish covering material, they should not be laid until all heavy construction is finished. Between the installation and putting the tiled area into service, it is imperative to properly protect the tile and grout in order to avoid construction related cleaning problems. There is a build-up of dirt and debris on each construction site. This dirt and debris may cause the grout, and sometimes the tile, to be negatively affected. VitrA recommends that a protective cover be put over the tile surface to safeguard the appearance. This will insure a quality appearance when the floor is ready for use. The protective cover could be cardboard, plywood or any other clean soft-covering that will not damage the integrity of the installation. Do not use plastic as it may not allow the grout to properly cure, and it also may become extremely slippery as construction dust settles on the floor.

1.2 Proper Selection and Use of Cleaning Agent

Use only recommended dilution of detergent. As an important rule, more is not always better; higher concentrations of detergent in the cleaning solution would only make it more difficult to rinse. However, hard water requires more frequent use of cleaning agents. When using any cleaning agent, please make sure to comply with the instructions for use and hazard indications of the cleaning agent manufacturer. VitrA does not assume any liability for damage incurred by non-compliance with these instructions and information.

The detergent solution must be given time to act on the soil load. Generally 5-10 minutes is sufficient. Rinse thoroughly with clean, clear water to remove the dirty detergent solution and soil. Rinsing is a critical step in the maintenance procedure. Remove the rinse water with a wet vacuum, dry mop or towelling. If dirty detergent solution is not removed and is allowed to dry on the surface, a coating will form which is very difficult to remove.

1.2.1. Warnings for Proper Selection and Use of Cleaning Agent:

- 1) VitrA tiles are chemically resistant to both acidic and alkaline chemical products as defined in EN ISO 10545-13, with the exception of hydrofluoric acids or compounds containing fluoride salts and derivatives. Hydrofluoric acid is the only one that will attack tiles due to their molecular structure, even when diluted with plenty of water. All spills must be cleaned as quickly as possible
- 2) Never use a cleaning agent forming sticky grease, wax and synthetic layers on the tiles, which have a negative effect on the visual, hygienic, anti-slip and cleaning properties. The cleaning agent that is chosen should also be compatible with the grout at the same time. Always test a small area first with the selected cleaning agent.

1.3 General Cleaning Procedure

The following principles apply for the cleaning procedure:

1. Selecting the appropriate cleaning agent.
2. Sweeping or vacuuming floor areas prior to cleaning to remove any dust or debris.
3. Leaving the cleaning agent to act for sufficient time upon the dirt and to loosen it.
4. Brushing or wiping mechanically.
5. Collecting, washing or sucking off the dirt separated from the tiles thoroughly.
6. Rinsing with water when the cleaning process is finished.
7. Removing the rinse water with a wet vacuum, dry mop or towelling.

Above are general recommendations. Any specific recommendations of cleaning agents, grout, grout removers etc. suggested by the individual manufacturer should be followed.

2. Döşeme Sonrası İlk Temizlik

Bakım için ilk adım, karo döşendikten sonra harç ve inşaat kirinin tamamen temizlenmesidir. Derzleri yüzeyden çıkarmak için piyasada birçok ürün bulunmaktadır. Bu ürünler, yoğun temizlik gerektiğinde daha yüksek konsantrasyonlar kullanma olasılığı ile derz dolgu malzemelerinin daha az birikmesi için seyreltilebilirler. Derz üreticileri tarafından ambalaj üzerinde harçların uygun şekilde karıştırılması, sertleşmesi ve temizlenmesi için talimatlar yazılır, bu talimatlar uygulanmalıdır. Temizleme işlemi; çimento harçları kuruduktan sonra yapılmalıdır. Çabuk kuruyan ürünler için en az 24-48 saat sonra yapılmalıdır. Her koşulda, derz üreticisinin talimatları takip edilmelidir. VitrA karolar, çoğu durumda, sıcak su ve nötr bir deterjan ile ovalarak temizlenir, ardından iyice durulanır ve daha sonra durulama suyunun ıslak vakum, paspas veya kuru havlu ile çıkarılması sağlanmalıdır. Derz kalıntısı hala mevcut ise, karonun temizlenmesi, derz üreticisine danışılarak gerçekleştirilmelidir. İlk temizlik tamamlandıktan sonra, sürekli ve uzun ömürlü güzel görünüm için günlük bakım prosedürleri takip edilmelidir.

Parlatılmış porselen karolar için, derz işleminin tamamlanmasından sonra, karo yüzeyi temizlenebilir ve yüzeydeki fazla koruyucu kaplama maddesi çıkarılabilir. Gerekirse yüzeydeki fazlalığı gidermek için kuru ve ıslak bir bez kullanılmalıdır (örn. MICROFIBER), üreticinin talimatlarına göre nötr deterjan eklenmeli, kalıntıların giderilmesi sağlanmalıdır. Her zaman önce küçük bir alan test edilmelidir. Kalıntı, pamuklu bir havlu/bez veya süngerle silinmeli ve temiz su ile iyice durulanmalıdır.

Kayma dayanımı olan yüzeylerde, dönen yumuşak naylon fırçalar veya mikrofiber içeren fırçalama makinelerinin yanı sıra yüksek basınçlı veya buhar basınçlı temizleyiciler ile mekanik temizlik etkili yöntemdir, bu sayede temizlik işlemi sırasında derzler korunmaktadır. Temizlik sırasında kayma dayanımını önemli ölçüde zayıflatabilecekleri için aşındırıcı taneli, uygun olmayan ped veya fırça kullanılmamalıdır!

2.1. Döşeme Sonrası Genel İlk Temizlik Talimatı

Temizlik işlemi, döşemeyi yapmış profesyoneller tarafından yapılmalıdır:

1. İnşaat tozunu temizlemek için zemin iyice süpürülmelidir.
2. Çimento film temizleyici, pakette belirtildiği şekilde suyla seyreltilmelidir.
3. Temizlik ürünü sıradan bir paspas ile uygulanmalıdır.
4. Etki etmesi için birkaç dakika beklenmelidir.
5. Scotch-Brite gibi aşındırıcı bir süngerle sertleşmiş bölgeler ovalanmalıdır.
6. Kalıntılar bezle silinmeli ve bolca temiz su ile durulanmalı ve paspas, ıslak vakum veya havlu ile kurulanmalıdır.

2.1.1. Döşeme Sonrası İlk Temizlik İçin Uyarılar:

1. Döşeme sonrası ilk temizlik, karo ile döşenmiş alana yakın nesnelere; kapılar, metalik objeler ve cilalar vb. zarar verebilir. Temizlik işlemine başlamadan önce bunların korunması tavsiye edilir.
2. Asit içerikli temizleyiciler çimento derzlerine etki eder. Bu nedenle derzler su ile nemlendirerek korunmalı ve asit temizleyicileri kullanıldıktan sonra kaplama temiz suyla iyice durulanmalı, mümkünse nötr hale getirilmelidir. Epoksi harçlar kullanılırken, özel olarak formüle edilmiş bir temizleyici kullanılmalı ve harç üreticisinin hazırlık, uygulama ve temizlik için talimatları uygulanmalıdır.
3. Özellikle metalik karolar ve metalik dekorlu karolar için, asidik olmayan derz temizleyicileri kullanılmalı, daima maksimum özen gösterilmelidir. Temizlik için ilk seçenek su olmalıdır. Daha güçlü bir temizleme gerekirse, alkol ve yumuşak bir bezle temizlenmeli veya alternatif olarak nötr PH içeren temizlik malzemeleri kullanılmalıdır. Aşındırıcı, asidik veya alkali temizlik ürünlerinden kaçınılmalıdır. Karo derzlerini temizlemek için hafifçe nemli bir sünger kullanılmalı ve diyagonal olarak uygulanmalıdır. Kirli su kullanılmamalıdır.
4. Sıcak ile birlikte kimyasalların reaksiyonu daha sert/aşındırıcı hale gelebileceğinden, çok sıcak olan (sıcak yaz günlerinde güneş ışığına maruz kalan) karolar asla temizlenmemelidir. Yaz aylarında, günün en serin döneminde, özellikle doğrudan güneş ışığına maruz kalınmayan zamanlarda temizlik yapılmalıdır.

3. Düzenli Temizlik

3.0. Genel Kurallar

Genellikle iki yöntem kullanılır:

- 1) Süpürge, ovma fırçası veya paspas kullanarak manuel olarak yapılan temizlik.
- 2) Makine yardımıyla temizleme; bir disk makinesi, vakum makinesi veya yüksek basınçlı temizleyiciyi sprey enjeksiyonuyla temizleme. Elle temizlik sadece az miktardaki kirler için önerilir. Makineler kullanıldığında, tek diskli veya çok diskli makineler veya fırça/ovalayıcı vakum makineleri en etkili seçeneklerdir. Sprey enjeksiyonlu yüksek basınçlı temizleyiciler, kaymaya dayanıklı yüzeyler için özellikle uygundur.

VitrA Cleaning and Care Instructions

2. First Cleaning After Installation

The first step for maintenance is complete removal of grout and construction dirt after tiles are laid. To remove the grout from the surface, there are many products available in the market. These products can be diluted for removal of light deposits of grouting materials with the possibility of using higher concentrations when aggressive cleaning is required. Grout manufacturers print instructions for proper mixing, curing, and cleaning of grout on packaging, these must be followed. This cleaning must be carried out after the cement grout has dried out, which takes at least 24-48 hours for quicksetting and quick-drying products. In any case the grout manufacturer's instructions must be followed. In most cases, VitrA tiles can be cleaned successfully by scrubbing the installation with hot water and a neutral detergent, followed by a thorough rinsing and then removing the rinse water with a wet vacuum, mop or dry towelling. If grout residue still remains, further cleaning of the tile should be accomplished in consultation with the grout manufacturer. Once the initial cleaning has been thoroughly completed, daily maintenance procedures can be followed for continuous and long-lasting beauty.

For polished porcelain tiles, following the completion of the grouting process, the tile surface can be cleaned and any excess protective sealer removed. Use dry and wet cloth (such as MICROFIBER) in order to remove excess, if needed, add neutral detergent according to manufacturer's instruction, help removing the residue. Always test a small area first. Wipe up the residue with a cotton towel or sponge. Rinse thoroughly with clean water.

In the case of anti-slip surfaces, mechanical cleaning by means of brushing machines with rotating soft nylon brushes or microfiber as well as high-pressure or vapour pressure cleaners is most effective, whereby joints must be cared during cleaning process. During the cleaning do not use improper pads or brushes with abrasive grain as they can significantly weaken non-slip safety!

2.1 General First Cleaning After Installation Procedure

Cleaning should be carried out by the professionals who have installed the material:

1. Sweep/vacuum the floor thoroughly to remove construction dust
2. Dilute the cement film remover in water as instructed on the package
3. Apply the cleaning product with an ordinary mop
4. Leave to act for a few minutes
5. Rub the zones with the toughest deposits hard with an abrasive sponge such as Scotch-Brite
6. Wipe up the residues using cloth and rinse with plenty of clean water and dry with mop, wet vacuum or towel.

Warnings for First Cleaning After Installation:

- 1) First cleaning after installation can damage objects close to the tiled area; such as doors, metallic objects and finishes; it is recommended to protect these before starting the cleaning operation.
- 2) Acid cleaners attack cement joints. Therefore, protect the joints by dampening with water and thoroughly rinse the covering with clear water after the use of acid cleaners, neutralise if possible. When using epoxy grouts, use a specially formulated cleaner and strictly follow the manufacturer's instructions for preparation, application and cleaning.
- 3) Especially for metallic tiles and tiles with metallic decors, use only non-acidic grout cleaners, always handle with maximum care. Water should be first option. If a stronger cleaning is needed clean with alcohol and a soft cloth or alternatively use a neutral PH. Avoid abrasive, acidic or alkaline cleaning products. Use a slightly damp sponge to clean the tile joints, passing it diagonally across them. Do not use dirty water.
- 4) Never clean tiles that are too hot (e.g. exposed to sunlight during hot summer days) since the reaction of chemicals may become harsher. In the summer, cleaning should be done during the coolest period of the day especially on areas exposed to direct sunlight.

3. Regular Cleaning

3.0. General Rules

Two methods are customarily used:

- 1) Manual cleaning using a broom, scrubbing brush or a mop.
- 2) Machine cleaning using a disc machine, scrubbing suction machine or high-pressure cleaner with spray injection.

Manual cleaning is recommended for only little dirt. When machines are used, single-disc or multi-disc machines or brush/scrubber suction machines are most effective options. High-pressure cleaners with spray injection are particularly suitable for slip-resistant surfaces. Which is the most rational method for these surfaces.

VitrA Temizlik ve Bakım Talimatları

3.0.1. Düzenli Temizlik için Uyarılar:

- 1) Seramik karolara dair verilen temizlik, bakım ve lekelerin çıkarılması ile ilgili tüm bilgilerde, en son öğrenilmiş olan bilgi ve malzemeler temel alınmaktadır. Bu nedenle, genel bir bilgidir ve her bir olasılığı kapsamamaktadır. Temizlik maddesi ve derz imalatçısı tarafından sağlanan talimatlara dikkat edilmelidir.
- 2) Rutin temizleyiciler asla asit veya amonyak içermemelidir. Asitler karonun sırlı yüzeyine ve derze zarar verebilir; amonyak, derzin rengini bozabilir.
- 3) Film oluşturu temizlik maddeleri, seramik kaplamaların kayma dayanımını önemli ölçüde azaltabilen, hatta yok edebilecekleri ve lekelenmeye neden olabileceği için kullanılmamalıdır.
- 4) Yüksek basınçlı temizleyicilerde, makine doğru kullanılmadığında (su jeti yüzeye çok yakın olduğu için basınç çok yüksekse) çimento derzlerini su ile çıkarılması ve zarar görmesi gibi bir tehlike söz konusudur. Uygun olmayan temizlik maddelerinin kullanılması, örneğin temizlik için asidik temizleyiciler bu etkiyi artırır.
- 5) Yerden ısıtma sistemlerinin olduğu yerlerde, ısıtma açıkken kir ve kirli suyun kurumadan temizlenmesi özellikle önemlidir.

3.1. Sırsız Karolar

VitrA sırsız karolar, koruyucu bir sırla kaplıdır, bu kaplama pişirimden önce sırdan farklı olarak karo üzerine püskürtülen özel bir yüzey hazırlık uygulamasıdır. Üretim işlemi sırasında, karo yüzeyinin yapısı, karonun lekelenmeye ve kirlenmeye karşı direncini daha da arttırmak için koruyucu bir malzeme ile kaplanır ve bunun sonucunda, emprenye maddesi ile ikincil işlemlere gerek kalmaz. Aşağıda bulunan temel temizlik prosedürü, koruyucu sırlı ve sırsız mat karolar için orta seviyedeki kirlenmelerde uygulanır. En iyi sonuçlar için aşağıdaki uygulamalara göre temizlik yapılması önerilir:

- 1) Tüm hafif tozlar, kirlere ve diğer yabancı maddeler süpürülmeli veya vakumlanmalıdır.
- 2) Zemin yumuşak bir temizleme solüsyonu ve sıcak su ile doyurulmalı, iyice karıştırılmalı/dağıtılmalı ve 5-10 dakika bekletilmelidir (yüzeyde kalması sağlanmalı). Temizleme solüsyonlarının kurumasına izin verilmemelidir. Tek seferde küçük alanları tamamlayarak ilerlemek en iyisidir.
- 3) Düzenli kullanımda nötr pH değerine sahip karo temizleyicilerle rutin olarak temizlenmelidir.
- 4) Kirli temizleme solüsyonu yüzeyden temizlenmeli, berrak su ile durulanmalıdır.
- 5) Kuru bir paspas veya havlu ile son işlem olarak yüzey kurulanmalıdır.

3.2. Sırlı Karolar

Duvar karoları, çok amaçlı, yağ bazlı olmayan temizlik kimyasalı ile rutin olarak temizlenmelidir. Temizleyici tipi, karo uygulamasına ve kullanımına bağlı olarak değişebilir. Duvar karolarında, sabun kalıntılarını, sert su birikintilerini ve günlük kullanımda oluşan kirlere temizleyen çok amaçlı bir sprey temizleyici kullanılabilir. Yer karoları, pamuklu paspas, bez, sünger veya metalik olmayan fırça kullanılarak bir temizlik solüsyonu yardımı ile temizlenmelidir.

Önemli Uyarı: Kuvvetli alkali veya kuvvetli asidik temizlik maddeleri, sırlı karoların yüzeyine ve derzlere zarar verip tahrip edebilir, bu nedenle bu tür temizlik maddeleri kullanılmamalıdır!

3.3. Parlatılmış Porselen Karolar

VitrA Protect, parlatılmış porselen karoların yüzeyine fabrikada üretim esnasında uygulanır, karolardaki leke ve kirlenmeye karşı direnci artırır.

VitrA, emprenye kimyasalları/maddeleriyle yapılan ikincil işlemleri önermez.

Önemli Uyarı: Parlaklığı arttırmak ve su lekelerini önlemek için temizlik tamamlandıktan sonra yumuşak bir bezle iyice kurulayın.

3.4. VitrA Clean Uygulanmış Karolar

VitrA Clean, VitrA İnovasyon Merkezi tarafından kolay bakım yapılabilen bir yüzey elde etmek için geliştirilmiştir. Kir parçacıkları, VitrA Clean uygulaması ile duvar karoları üzerinde tutunamaz ve su damlacıkları ile akar. Su ve yumuşak bir bez yardımı ile yoğun deterjanlara ihtiyaç duymadan rutin temizlik yapılabilir.

3.5. Kayma Direnci Olan Karolar

VitrA ürün yelpazesinde çok sayıda kaydırmaz özellikli sırlı ve sırsız ürün bulunmaktadır. Bu ürünler ticari, endüstriyel, kamusal alanlarda ve yüzme havuzları, duşlar, saunalar gibi ıslak alanlarda kullanım için uygundur. Uygulama alanına bağlı olarak pürüzsüz, mikro-pürüzlü veya rölyef tipi yüzeylere sahiptirler. Kaydırmaz yüzeylerde, dönen yumuşak naylon veya mikrofiber fırçalı yüzey temizleme makinelerinin yanı sıra yüksek veya buhar basınçlı temizleyiciler ile mekanik temizlik en etkili yöntemdir. Bu sayede temizlik işlemi sırasında derzlere zarar verilmemektedir. Kirlenme ve uygulama alanlarına göre temizlik maddeleri, ekipman ve yöntemler belirlenmelidir. Pürüzsüz, sırlı yüzeylere kıyasla kapsamlı bir temizlik gereklidir.

VitrA Cleaning and Care Instructions

3.0.1. Warnings for Regular Cleaning:

- 1) All of the information provided about cleaning, care and removing stains from ceramic tiles is based on the latest knowledge and material. It is, however, a general information and cannot cover every single possibility. Therefore, please pay attention to the instructions provided by the cleaning agent and grout manufacturer.
- 2) Routine cleaners should never contain acids or ammonia. Acids can damage the grout and the glazed surface of the tile, and ammonia can discolour the grout.
- 3) Film-forming cleaning agents should not be used as they can considerably reduce or even neutralise the slip resistance of ceramic coverings, and can also cause staining.
- 4) With high-pressure cleaners there is a slight danger of washing out and destroying cement joints if the machine is not used correctly (pressure too high because water jet is too close to surface). Using of unsuitable cleaning agents, e.g. acidic cleansers for cleaning increases this effect.
- 5) Where underfloor heating systems are installed, it is particularly important to ensure that the removed dirt and dirty water is cleaned before it is able to dry again when heating is on.

3.1. Unglazed Tiles

VitrA unglazed tiles has a protective glaze finish that is not a glaze, but rather a special surface preparation sprayed on the tile before firing. During the manufacturing process, the structure of the tile surface is sealed with a protective glaze in order to further increase the tiles' resistance to staining and dirt, as a result of which subsequent treatment with impregnating agents is no longer necessary. The following represents a simple procedure for maintaining protective glaze coating and unpolished matte finish tile floors with a moderate soil load. For best results:

1. Sweep or vacuum the floor of all loose dirt and other foreign materials.
2. Saturate the floor with a mild cleaning solution and hot water, agitate, and allow it to dwell (remain on the floor) 5-10 minutes. Do not allow cleaning solutions to dry. It may be best to complete small areas at a time.
3. Clean routinely with tile cleaners that have a neutral pH for safe regular use.
4. Remove the dirty cleaning solution and rinse the surface with clean, clear water.
5. Buff with a dry mop or towel.

3.2. Glazed Tiles

Wall tiles should be cleaned routinely with an all-purpose, non-oil-based household or commercial cleaner. The type of product may vary depending on the tile application and use. A multipurpose spray cleaner, which removes soap residue, hard water deposits and dirt designed for everyday use can be used on wall tiles. Floor tiles should be cleaned and scrubbed with cleaner solution through the use of a cotton mop, cloth, sponge, or non-metallic brush.

Important Notice: Strongly alkaline or strongly acidic cleaning agents can attack or destroy the surface of glazed tiles and joints and must therefore not be used!

3.3. Polished Porcelain

VitrA Protect is applied to the surfaces of the polished porcelain tiles at the factory, improving the resistance to staining and soiling. VitrA does not recommend subsequent treatment with impregnating agents.

Important Notice: Dry thoroughly with a soft cloth after cleaning is completed to increase the shine and prevent water spots.

3.4. VitrA Clean Surface

The VitrA Clean finish was developed to achieve an easy-care tile surface by VitrA Innovation Center.

Dirt particles are virtually unable to hold and flow off with the water droplets on wall tiles with VitrA Clean application. Water and a soft cloth are sufficient for routine cleaning without a need for aggressive detergents.

3.5. Antislip Tiles

VitrA product range includes a great number of anti-slip glazed and unglazed series. These products are perfectly suitable for use in commercial, industrial and public areas as well as in wet barefoot areas such as swimming pools, showers and saunas. They have smooth, micro-rough or relief-type surfaces, depending on the area of application. In the case of anti-slip surfaces, mechanical cleaning by means of brushing machines with rotating soft nylon brushes or microfiber as well as high-pressure or vapour pressure cleaners is most effective, whereby joints must be cared during cleaning process. Cleaning agents, equipment and methods must be selected due to type of soiling and area of application. An extensive cleaning is required compared to smooth, glazed surfaces.

VitrA Temizlik ve Bakım Talimatları

Havuz Endüstrisi için Alman Topluluğu tarafından sağlanan RK Listesinde (yüzme havuzlarındaki seramik yüzeyler için test edilmiş temizlik maddelerinin listesi) uygun temizlik maddelerinin seçimi anlatılmıştır. İlgili üretici tarafından verilen kullanım ve tehlike uyarılarına uyulmalıdır. Bu tür zemin yüzeyini temizlemek için önerilen birkaç yol vardır:

- Yüksek basınçlı temizlik ekipmanları (Basınçlı yıkayıcılar veya yüksek basınçlı hortumlar).
- Buharlı temizleyiciler
- Diskli yer temizleyiciler
- Yüzeyi aşındırıcı olmayan sert plastik bir fırça ile ovalamak (kayma direncine zarar vermeden) ve bolca temiz su ile durulamak

3.5.1. Kaydırmaz Özellikli Karoların Temizliği İçin Uyarılar:

- 1) Aşındırıcı özellikli fırçalar, pedler veya bezler, kayma direncini azalttığı için hiçbir koşulda kullanılmamalıdır.
- 2) Yer temizleme/cilalama makineleri, kayma dayanım özelliğini azaltmaması için kaymaya karşı dayanıklı karolara uygun olarak kullanılmalıdır. Kayma dayanım özelliği, karo yüzeyinin pürüzlülüğü veya rölyef ile elde edilir.
- 3) Tüm temizliklerde, temiz su kullanılması önemlidir. İyi sonuçlar elde etmek için yüzeyin bol su ile durulanması gerekir.
- 4) Temizleme maddesi zeminin kayganlaşmasına neden olabilir. Bu nedenle, kaymaya sebep olan ve kayma direncini olumsuz yönde etkileyen yağlı bir tabakanın oluşmasını önlemek için yüzeydeki temizlik maddesi iyice durulanmalıdır. Kaydırmaz özellikli yer karoları temizlendiğinde, yüzeyleri nasıl olursa olsun, bunları nemli paspas ile temizlemek yeterli değildir, çünkü karolarda kayma direncini sağlayan parçacıklara gömülmüş kirleri temizlemeyecektir. Bu da kirlerin birikerek yüzeyinin genel görünümünü bozmasına ve rengin biraz değişmesine neden olacaktır.
- 5) Temel ve düzenli bakımda alkali temizlik malzemeleri kullanılmalıdır. Eğer temizlik için kullanılan su yumuşaksa, daha az sıklıkta (su ve suyun sertliğine bağlı olarak haftalık veya aylık) yüzeye zarar vermeyen asidik temizlik malzemeleri kullanmak gerekir. Sert su, daha fazla temizlik kimyasalına ihtiyaç duymaya neden olur.

3.6. Metalik Karolar/Dekorlar

Bazı karolar üzerinde gümüş / platin / altın / bakır etkisi ile parlak bir görünüm veren metal dekorlar bulunmaktadır. Bu karolar kataloglarda belirtilmiştir ve döşeme sırasında, döşeme sonrası ilk temizlikte ve genel temizliklerde çok dikkatli ve özenli olunmalıdır. Yüzeyi çizebilecek ve zarar verebilecek aşındırıcı temizleyiciler kullanılmamalıdır. VitrA, su ve alkol ile yumuşak bir bez kullanmanızı önerir. Temizledikten sonra, su lekelerini önlemek için yüzey temiz bir pamuklu bezle kurulanmalıdır.

Önemli Uyarı: Metalik karolar / dekorlar asla duş, banyo gibi ıslak mekanlarda kullanılmamalıdır.

3.7. Fotokatalitik Karolar

Temizlik için, fotokatalitik kaplama içermeyen diğer karolarda kullanılan ürünler kullanılabilir - daha düşük konstrasyona sahip temizlik maddeleri de yeterli olabilmektedir. Karo üzerinde bir film, yağlı ya da yapışkan bir tabaka oluşturan herhangi bir temizlik malzemesi, fotokatalitik etkiyi bozar ve bu tür tabaka oluşturan malzemeler karo yüzeyinin ışık almasını engeller. Bahsi geçen uygulamalar, bu tür karoların özelliklerini azaltacağından yapılmamalıdır. Temizlik için kullanılan malzemeleri iyice durulamak ve yüzeyden arındırmak çok önemlidir.

*Ürünler için teknik bilgiler, döşeme talimatları, garanti koşulları, temizlik ve bakım talimatlarıyla ilgili güncel bilgiler VitrA web sitesinde yer almaktadır:

www.vitra.com.tr / <https://vitraglobal.com/>

VitrA Cleaning and Care Instructions

A selection of suitable cleaning agents is outlined in the RK List (list of tested cleaning agents for ceramic surfaces in swimming pools) supplied by the German Society for the Pool Industry. In any case, the instructions for use and hazard warnings provided by the respective manufacturer must be respected.

There are several recommended good ways of cleaning this type of floor surface:

- High-pressure cleaning equipment (Pressure washers or high-pressure hoses).
- Vapour steam cleaners.
- Disc cleaners
- Scrubbing the surface with a brush with hard plastic bristles and then rinsing it with plenty of clean water.

3.5.1. Warnings for Antislip Tiles Cleaning:

- 1) Brushes or pads containing abrasives must not be used under any circumstances, as they reduce slip resistance.
- 2) When using disc machines, suitable pads must be used, particularly on slip-resistant tile coverings in order to prevent cleaning from impairing the slip resistance. The slip-resistant properties are achieved through the roughness of the tile's surface or by means of relief-type profiling.
- 3) Whichever cleaning system is used, it is important to use clean water because otherwise, when the water evaporates, small particles of dirt from the water will be deposited in lower, more inaccessible parts of the embossed surface. For good results, it is essential to rinse with plenty of water.
- 4) Cleaning agent may cause the floor to become slippier, therefore they should be rinsed thoroughly to avoid forming a greasy layer which negatively affects anti-slip safety. When anti-slip floor tiles are cleaned, whatever their surface finish, it is not sufficient to clean them with damp mopping, because it will not clean away any dirt embedded in the particles that give the tiles their anti-slip finish. This means that dirt will build up, spoiling the overall appearance of the floor surface and normally modifying the colour slightly.
- 5) Alkaline cleaning agents should be used for basic cleaning and regular maintenance cleaning. Where water is soft, only occasional acidic cleaning is necessary (weekly or monthly depending on the flow of water and water hardness). Hard water requires more frequent use of cleaning agents.

3.6. Metallic Tiles/Decors

Some tiles are made out of metal-containing decoration which gives a shiny appearance with a silver / platinum / gold / copper effect. These tiles are indicated in the catalogue. For these tiles, extreme care must be taken during their installation, first cleaning after installation and general cleaning. Avoid using abrasive cleaners that can scratch and damage the surface. VitrA recommends using a soft cloth with water and alcohol. After cleaning, dry the surface with a clean cotton cloth to avoid water mark.

Important Notice: Never install metallic tiles/decors in wet areas such as showers, baths.

3.7. Photocatalytic Tiles

The same products can be used for cleaning as for similar tiles without photocatalytic coating - with the advantage that the concentration of the cleaning agent can be considerably lower.

Any cleaning material forming a film or a greasy or sticky layer on the tile would impair the effectiveness of photocatalytic and must be avoided as they impede the incidence of light onto the tile surface.

It is very important to thoroughly remove cleaning and disinfecting agents.

* You can find most recent information about our products, Warranty Conditions, Cleaning and Care Instructions, along with other Product Performance Data and Installation specifications at:
www.vitra.com.tr / <https://vitraglobal.com/>

CE Markalaması – Performans Beyanı ve VOC Etiketi

CE markalaması bir ürünün beyan edilen performansına uygun olduğunu ve uyumlandırılan Avrupa standardına göre değerlendirildiğini göstermektedir. CE işareti AB için gerekli olan güvenli ürün sertifikalandırmasıdır ve insanların sağlığını ve binalardaki ürünleri korumak için oluşturulmuştur. Vitra ürünlerinin CE markalaması No 305/2011 no.lu Yönetmeliğin (AB) Ek V kısmına göre hazırlanmıştır. (568/2017 no.lu Delege edilen AB Yönetmeliğine göre değiştirilmiştir.)



Vitra ürünlerinin performanslarının beyanı 574/2014 no.lu delege edilen AB yönetmeliğinde sunulan modele göre hazırlanmıştır. Seramik karoların yangın reaksiyonu (1.Sistem) için test edilmesi gerekli değildir ve bunlar test edilmeden sınıflandırılmaktadır (96/603/EC Komite kararına göre).

Vitra DoP'ları kataloglarda ve aşağıdaki web sitesinde mevcuttur:

<https://www.vitra.com.tr/performans-banyo-karo/>

Uçucu organik bileşenler (VOC'ler) belirli koşullarda belli katı ve sıvılardan gaz olarak atılırlar (Örneğin fazla yüksek basınç altında vb.). VOC'lerin kaynama aralığı 50-100 °C ve 240-260 °C aralıklarındadır. Seramik karolar 1100 °C'nin üzerindeki sıcaklıklarda üretilirler ve bu yüksek ısı sürecinden dolayı, ürün artık VOC maddelerini içermez. 1 Eylül 2012 tarihinden itibaren Fransa'da tüm yapı ürünleri VOC emisyon testlerine göre emisyon sınıflandırması ile etiketlenmelidirler. Emisyon açısından nötr olan ürünler olarak karolar A+ olarak sınıflandırılmaktadırlar. Etiket kutuların üzerinde bulunmaktadır.



CE Marking – Declaration of Performance and VOC Label

The CE marking indicates that a construction product conforms its declared performance and it has been assessed according to a harmonised European standard. The CE mark is the safety product certification required by EU and it is finalized to preserve the people's health and the goods in buildings. The CE marking of the Vitra products is prepared according to the Annex V of the Regulation (EU) No 305/2011 (amended by Delegated Regulation EU No 568/2017)



All the declaration of performances of the Vitra products are prepared according to model provided in Delegated Regulation EU No 574/2014. Ceramic tiles do not require to be tested for reaction to fire (System 1) and are classified without testing (according to Commission Decision 96/603/EC).

Vitra DoPs are available on the catalogues and on the website:

<https://www.vitra.com.tr/performans-banyo-karo/>

Volatile organic compounds (VOCs) are emitted as gases under certain conditions (i.e. excessively high pressure etc.) from certain solids or liquids. The boiling range of VOCs is between 50-100 C and 240-260 C. Ceramic tiles are manufactured at temperatures higher than 1100 C and as a result of this high temperature process condition, the product no longer contains VOC substances. Since 1 September 2012 in France, all building products have to be labelled with an emissions classification on the basis of VOC emissions tests. As emission-neutral products, they are classified as A+. This label can be found on the boxes.



UPEC

QB sertifikalandırma işareti ile ilgili UPEC sınıflandırması referans belgelerinde belirtilen teknik gerekliliklerle zemin kaplamalarının uygunluğunu teyit eder. UPEC standartlarına göre sınıflandırılan bir ürüne sahip olmak zorunlu olmasa da, bu sınıflandırma müşteriye kullanım amacına uygun ürünün seçilme imkanını vermektedir.

UPEC sınıflandırması Paris'teki CSTB (Centre Scientifique et Technique du Bâtiment, Bilimsel ve Teknik Yapım Merkezi) tarafından gerçekleştirilmektedir.

Dört harf U, P, E ve C aşağıdakileri ifade etmektedir:

U: Aşınma dayanımını göstermektedir ve EN ISO 10545-7'ye göre aşınma gruplarına karşılık gelmektedir. U sınıflandırması 2 (minimum stres) ile 4 arasında olabilmektedir.

P: Zeminin maruz kalması beklenen mekanik stresleri ifade etmektedir. Bu stresler hareketli veya sabit döşeme kullanımları veya zemine düşen nesnelere nedeniyle oluşabilmektedir. Bu ayrıca eğilme (gerilme) direnci kullanılarak da tanımlanmaktadır. Uygulamada beş sınıflandırma: 2, 3, 4, 4+ ve 4s (En yüksek sertlik) kullanılmaktadır.

E: Zemin kaplamasının su duyarlılığını göstermektedir. Bu E sınıflandırması 1 ile 3 arasında olabilmektedir. En yüksek sınıf olan 3 seramik karolar için tanımlanmıştır. Karoların E3 sınıflandırmasının karo döşenmiş bir zeminin su geçirmez olduğu anlamına gelmediği hatırlanmalıdır.

C: Bu kaplamanın dayanıklılığı üzerinde olumsuz etkisi olan kimyasal ve lekelenme maddelerine karşı dayanıklılığını tanımlamaktadır (Farklı derinliklere nüfus eden lekeler). C Endeksi minimum 0 seviyesinden (en düşük risk) 2 düzeyine çıkabilmektedir (Bazı laboratuvar gibi belirli odalar için istisnai olarak sınıf 3 olarak verilebilir).

Sadece onaylı üreticiler test edilen karoların UPEC sınıflandırmasını belirleme hakkına sahiptirler. Bu karolar için etiket üzerinde QB-UPEC logosu ve ürünün UPEC sınıflandırması gösterilir.

Bu sertifikalandırma şunları garanti etmektedir:

- Karoların EN 14411 standardının ön şartlarını karşıladığını,
- Karoların UPEC sınıflandırmasında tanımlanan belirli aşınma dayanım özelliklerine sahip olduğunu (Bağımsız bir laboratuvar tarafından düzenli kontrol yapılarak)
- Karoların aşırı katı olan kural ve yönetmeliklere göre düzenli kontrol edilen bir üretim sürecinden geçerek üretildiğini.

Bunlar sadece bilgi amaçlı olarak verilmiştir. CSTB, bu teknik bilgileri ve ürünlerin UPEC sınıflandırmasını yenileme/güncelleme hakkına sahiptir.

VitrA sertifikalı ürünlerinin tam ve güncel listesi aşağıdaki adresten görüntülenebilmektedir:

<http://evaluation.cstb.fr/fr/carreau-ceramique/detail/1909/>

<http://webapp.cstb.fr/upec-ceramique/index.php?view=TitulaireGammeSerie&sid=32>



UPEC

UPEC classification associated with the QB certification mark attests to the compliance of floor coverings with the technical requirements set out in certification reference documents. Although it is not compulsory to have an item classified according to UPEC standards, this classification means giving a customer the opportunity to choose an appropriate product for the intended use.

The UPEC classification is performed by the CSTB (Centre Scientifique et Technique du Bâtiment, Scientific and Technical Building Centre) in Paris.

The four letters U, P, E and C stand for:

U: It indicates the wear resistance and corresponds to the wear groups as per EN ISO 10545-7. The index U can go from 2 (minimum stress) to 4.

P: It indicates the mechanical stresses to which the floor is expected to be subjected. These stresses can be caused by mobile or fixed furnishing uses or objects falling on the floor. It is also defined using the bending (tensile) strength. In practice the five indices 2, 3, 4, 4+ and 4s (highest toughness) are assigned.

E: It indicates the water sensitivity of the floor covering. This index E can go from 1 to a maximum of 3. The highest index 3 is always assigned to ceramic tiles. It is however remembered that the classification E3 of the tiles does not imply that a tiled floor is waterproof.

C: It indicates the resistance to chemical and staining substances that have a negative effect on the durability of the covering (stains, attacks that penetrate to various depths etc.). The index C can go from a minimum of 0 (lowest risk) to 2 (exceptionally 3 for particular rooms, as some laboratories).

Only certified manufacturers have the right to stipulate the UPEC classification of tested tiles. These tiles display the QB-UPEC logo on the labels and the UPEC classification of the product is indicated as well.

This certification guarantees:

- that the tiles comply with the prerequisites of the EN 14411 standard,
- that the tiles actually possess the specified wear-resistance characteristics, as defined by the UPEC classification (regular checking by an independent laboratory)
- that the tiles originate from a constantly controlled manufacturing process according to the extremely strict rules and regulations.

This is provided for information purposes only. CSTB has the right to replace/revise this technical information and the UPEC classification of the products.

The full, up-to-date list of certified products of VitrA can be viewed at the following address:

<http://evaluation.cstb.fr/fr/carreau-ceramique/detail/1909/>

<http://webapp.cstb.fr/upec-ceramique/index.php?view=TitulaireGammeSerie&sid=32>



Sertifikalar

Yönetim Sistemleri Sertifikaları



ISO 9001:2015



ISO 14001:2015



ISO/IEC 27001:2013



OHSAS 18001:2007



ISO 14001:2015

Ürün Sertifikaları



EU Ecolabel Sertifikası*



Greenguard Gold Sertifikası



QB UPEC Sertifikası*

Türk Standartları Enstitüsü Sertifikaları



Türk Standartları Enstitüsü Çift Yıldız Kriterine Uygunluk Sertifikası



Türk Standartları Enstitüsü Türk Standartlarına Uygunluk Belgesi

*Sadece belirli ürünlerde/serilerde geçerlidir.
Güncel sertifikalar için lütfen aşağıdaki web-sitelerine başvurun:
<https://vitraglobal.com/catalogues/quality-certificates>
<https://www.vitra.com.tr/kalite-sertifikalari/vitra-karo/>

Certificates

Management System Certificates



ISO 9001:2015



ISO 14001:2015



ISO/IEC 27001:2013



OHSAS 18001:2007



ISO 14001:2015

Product Certificates



EU Ecolabel Certificate*



Greenguard Gold Certificate



QB UPEC Certificate*

Turkish Standard Institute Certificates



Turkish Standards Institute Certificate of Conformity to Double Star Criteria



Turkish Standards Institute Certificate of Conformity to Turkish Standards

*For specific products/series only.
Please refer to the website for the up-to-date certificates:
<https://vitraglobal.com/catalogues/quality-certificates>
<https://www.vitra.com.tr/kalite-sertifikalari/vitra-karo/>

VitrA Garanti Koşul ve Kuralları

1. Ürün Kalitesi

- 1.1. "Kalite: 1" olarak tanımlanan ürünler, Avrupa Kalite Standardı EN 14411'in gerekliliklerini sağlamaktadır. "Kalite: 1" dışında tanımlanan ürünler ise CE-sembolünün gerekliliklerini sağlar, ancak EN 14411 standardının, CE işareti gereklilikleri haricindeki görsel veya teknik 1. Kalite gerekliliklerini sağlamayabilir.
- 1.2. Teslim edilen ürünlerin renk, yüzey görünüşünün benzer olmaması ya da ürünlerin numunelerle, mağaza teşhirleriyle, web sitesindeki görüntüler veya basılı evraklar ile tam olarak uymaması durumunda hiçbir sorumluluk kabul edilmez (Örneğin Kataloglar, broşürler, fiyat listeleri vb.). Bu durum üretimde kullanılan doğal hammaddelerin değişkenliğinden ve seramik üretim prosesinden kaynaklanmaktadır. Özellikle mozaiklerde, Avrupa Kalite Standardı EN 14411'in kalite gereklilikleriyle sınırlı olacak oranda hafif renk değişimleri beklenmektedir.
- 1.3. Karolar, bazı serilerdeki ürün tasarımı kaynaklı olarak, renk, doku ve görünüş olarak değişiklik gösterebilir. Özellikle desen farklılaşması V3, V4 olarak tanımlanan ürünler kutu içindekilerle, numunelerle, ticari numunelerle ve teşhirlerle önemli ölçüde farklılık gösterebilir. Ürün seçimi sırasında desen farklılaşmasına dikkat etmenizi önemle bilgilerinize sunarız.
- 1.4. Boyut ve kalınlığı bakımından ISO 13006, EN 14411 ve ANSI 137.1 standartlarında belirtilen toleranslar içerisinde olan ürünler kusur teşkil etmez. Bu durum, farklı sevkiyatlarda gönderilen ürünlerin her teslimatı için geçerlidir.
- 1.5. Tüm zemin kaplamaları, uygulama alanına, kullanım yoğunluğuna, kirleticinin türüne ve kirlenmenin yoğunluğuna, ayrıca söz konusu ürünün sertliğine ve aşınma direncine bağlı olarak aşınma ve yıpranmaya maruz kalır. Stres gruplarındaki sınıflandırma, sırlı yüzeyin aşınma direncine karşılık gelir, ancak basınç veya ağır yüklerin neden olduğu gerilime/sürtünmeye karşılık direncini göstermez.
- 1.6. Dekoratif sırlar söz konusu olduğunda, sır içindeki çatlaklar (döşmeden önce / sonra oluşan) doğal bir etkidir ve karoların amacına yönelik kullanımına olumsuz bir etkisi olmaz veya bir hata teşkil etmez.
- 1.7. Ürün seçimi sırasında, fiyat listeleri veya kataloglarda bulunan kullanım alanı önerilerine dikkat edilmelidir.

2. Şikayet Yönetimi

- 2.1. Teslim edilen ürünlerin, doğru, eksiksiz ve herhangi bir kusur taşımadıklarından emin olmak için teslim alındıktan sonra derhal kontrol edilmelidir. Teslimatın indirilmesi sırasında belirlenen paletler üzerinde harici / görünür bir hasar varsa, söz konusu paletlerin ambalajları açılmalı ve ürünler gözden geçirilmelidir. Tüm şikayetler VitrA'ya gecikme olmaksızın en geç 14 gün içinde yazılı olarak bildirilmelidir. Kutular açılmadan anlaşılabilen tüm hatalar da en geç 14 gün içerisinde, karolar döşenmeden önce VitrA'ya yazılı olarak bildirilmelidir. Hata olduğu düşünülür veya görülürse ürünler döşenmemelidir. Yazılı şikâyetin bulunmadığı veya ürünlerin döşendiği durumlarda, ürünlerin müşteri tarafından kabul edildiği varsayılır ve ürünler kusursuz kabul edilir.
- 2.2. Kusurlu ürünler, hata fark edildiğinde sökülmemeli ve kontrol için hazır halde bulundurulmalıdır. Kutu, palet ve kutu etiketleri, şikâyetin incelenmesi için saklanmalıdır. Ürünlerin hataları fark edildiğinde döşeme işlemleri durdurulmalı, şikâyet çözülene kadar kusurlu ürünler saklanmalıdır. Yukarıdaki şartların ihlali durumunda VitrA herhangi bir ürün değişimi veya herhangi bir ödeme yapma yükümlülüğü taşımamaktadır.
- 2.3. Şikâyet, halihazırda döşenmiş karolar içinse, VitrA, yalnızca temizlik ve bakım talimatlarına göre uygun şekilde kullanılan karolarda ortaya çıkan kusurlar için bir yükümlülük taşır. Karolar, VitrA'ya makul bir süre içinde kusuru inceleme fırsatı verildikten ve VitrA yazılı olarak izin verdikten sonra sökülebilir, aksi takdirde işlem yapılamaz.
- 2.4. VitrA tarafından üretim hatası olarak kabul edilen şikâyetlerde yapılacak değişim sadece hatalı karoların değiştirilmesi ile sınırlıdır.
- 2.5. VitrA, satın alınan üründe hata çıkması durumunda birebir değiştirme, tamir etme, iade alma veya muadili ile değiştirme hakkını saklı tutar.
- 2.6. VitrA veya yetkili temsilcileri tarafından ürün incelemesi yapılmadan hiçbir talep ve şikâyet kabul edilmeyecektir.
- 2.7. Müşteri, herhangi bir kusurun bulunmasından sonraki 14 gün içerisinde VitrA'yı, yetkili temsilci veya satıcıyı yazılı olarak bilgilendirmelidir. Talepler web sitesi aracılığıyla da bildirilebilir:
www.vitra.com.tr/iletisim / <https://vitraglobal.com/contact>

3. Garanti Koşulları

- 3.1. Web sitesinde, broşürlerde, tekliflerde, ürün açıklamalarında, çizimlerde, numunelerde, Uygunluk Sertifikasında veya diğer beyanlarda bulunan bilgiler, (Örneğin boyutlar, ağırlıklar veya diğer performans kriterleri) bağlayıcı bir garanti değildir, sadece genel ürün bilgileri olarak kabul edilmelidir.
- 3.2. Garanti, ürünlerin müşteri tarafından doğru ve amacına uygun olarak kullanılması şartıyla, malzeme, işçilik ve üretim kaynaklı bir hata içeren durumlarda; VitrA'nın şartlarının, endüstride kabul edilen EN 14411 ve ANSI 137.1 gibi standartlardaki toleransların dışına çıkıldığı durumlarda geçerlidir. Bayiler/temsilciler, ürünlerin müşteri tarafından doğru ve amacına uygun olarak kullanılması şartıyla, malzeme, işçilik ve üretim kaynaklı bir hata içeren durumlarda; VitrA'nın şartlarının, endüstride kabul edilen EN 14411 ve ANSI 137.1 gibi standartlardaki toleransların dışına çıktığı durumlarda müşteriye karşı sorumlu olacaktır. Bölüm 2'de belirtilen şartlar yerine getirilmişse, VitrA, müşterinin hatalı ürünlerden oluşan zararını karşılamak için, mevcut stoklara ve hata tipine bağlı olarak, onarım yapma, hatalı ürünü kusurlu olmayan birebir veya eşdeğer ürünlerle değiştirme hakkını saklı tutar. VitrA tarafından beyan edilen çözüm yönteminin dışında bir talep kabul edilmeyecektir. Tamamen görsel kusurlardan oluşan durumlarda (Örneğin matlık / parlaklık farklılıkları, renk tonu farklılıkları, dijital baskı hataları ve ince baskı çizgileri vb.), hatalı ürün adediyle sınırlı olmak şartıyla ürün satış bedeli üzerinden indirim talep etme hakkı verir, döşenen ürünlerde değişim yapılmaz.
- 3.3. Ürünün fiziksel veya kimyasal olarak hatalı kullanıma maruz kalması veya ihmalkarlık dahil olmak üzere müşteri tarafından herhangi bir şekilde yanlış kullanılması durumu kullanıcı hatası olarak değerlendirilir ve söz konusu ürün garanti kapsamında değerlendirilmez.
- 3.4. Döşenmiş/döşenmemiş karo, dekor veya süpürgelikler üzerinde herhangi bir yapıştırıcı madde içeren malzeme ile uygulama yapılmamalıdır. Bu uygulama neticesinde ortaya çıkabilecek direkt hasarlar kullanıcı hatası olarak kabul edilir ve VitrA herhangi bir ürün değişikliği veya ödeme yapma yükümlülüğü taşımamaktadır.
- 3.5. Yukarıda tanımlanan durumlarda, kararın nihai olarak taraflarca yetkili tayin edilen bir mahkeme tarafından verilmesi şartıyla sadece oluşan direkt hasar/zarar VitrA tarafından tazmin edilir.
- 3.6. Müşteri, eline kırık olarak ulaşan ürünler/paletler ile ilgili, 14 takvim günü içinde VitrA'yı yazılı olarak bilgilendirmek ve tüm kırık ürünleri VitrA tarafından yetkilendirilmiş teknik uzmanlarca incelenmesi için muhafaza etmekle yükümlüdür. Kırık oluşumunun palet dizilimi kaynaklı olmadığına teknik uzmanlarca tespiti halinde VitrA, herhangi değişim ve tazminat taleplerinden sorumlu değildir.

VitrA Terms and Warranty Conditions

1. Product quality

1.1. Products designated as “Quality: 1” comply with the quality requirements of European quality standard EN 14411. Those designated other than “Quality: 1” comply with the requirements for the CE-symbol but not with the aforementioned standard and exhibit technical and/or visual defects excluding them from classification as “Quality: 1” products.

1.2. No liability can be assumed if the colour, surface appearance of the goods delivered is not even or if the goods do not exactly match the samples or merchandising, the images on the website or the printed material (i.e. catalogues, brochures, price lists etc.). This is due to the variability of the natural raw materials and the ceramic production process.

Particularly in mosaics, some colour variation is to be expected which is limited to the quality requirements of European quality standard EN 14411.

1.3. Tiles may vary in colour, texture or appearance according to product design for particular tile collections. Especially Shade Variation V3, V4 type products may vary significantly within boxes, samples, merchandising and display. It is strongly recommended to pay attention to Shade Variation during product selection.

1.4. Normal tolerances with respect to size and thickness do not constitute flaws. This shall also apply to any subsequent deliveries.

1.5. All floor coverings are subject to wear and tear depending on the area of application, the frequency of contact, the type and degree of soiling as well as the hardness and wear resistance of the product in question. The classification in stress groups refers to the wear resistance of the glazed surface, but not to the resistance to strain caused by pressure or heavy weights.

1.6. In the case of some artistic and decorative glazes, crazing in the glaze (formed before/after laying) is a natural effect and do not impair the ability to use the tiles for their intended purpose or constitute a defect.

1.7. During product selection, please pay attention to recommendations for area of use for suitable products in the price lists or catalogues.

2. Complaint Management

2.1. The delivered goods shall be inspected immediately upon receipt to ensure that they are correct, complete and free of any defects. If there is an external/visible damage on the pallets identified during unloading of the delivery, the customer must remove the packaging for the pallets in question and inspect the goods. Any complaints shall be referred to VitrA in writing without delay and at the latest within 14 days.

Any defects that do not become obvious until after the boxes have been opened shall also be reported in writing within 14 days and, in any case, prior to being laid. In any case, they may not be laid. In the absence of any written complaint or if the goods are laid, they are assumed to be accepted by the customer and the products are free of any defects.

2.2. Defected products must be kept ready and available for inspection at the time of realising the defects, without any removal of the tiles. Pallet and box labels should be stored as reference for analysing the defects thoroughly. All further processing of such goods must be stopped. The customer shall duly store the defected products until the complaint has been settled. In the event of a violation of the above obligation, VitrA does not carry an obligation to provide any replacements or any kind of payment.

2.3. If the complaint includes tiles that are already laid, VitrA carries an obligation only for those defects that become evident only after the tiles that are properly used according to the maintenance and care instructions. The tiles can be removed only after VitrA has been given the opportunity to inspect the defect within a reasonable time period and VitrA has given consent for removal in writing.

2.4. In any case, the removal of the tiles laid is limited to the defected tiles only.

2.5. VitrA reserves the right to repair, refund or replace the purchased or an equivalent product (to the same value) at its sole discretion.

2.6. No claim will be accepted without product inspection by VitrA or its authorized representatives.

2.7. The customer must notify VitrA, authorized representative or seller in writing within 14 days of the discovery of any defects. Claims can be notified via website:

www.vitra.com.tr / <https://vitraglobal.com/contact>

3. Warranty Conditions

3.1. Information contained on website or in brochures, offers, product descriptions, drawings, illustrations, Certificate of Conformities or other declarations, e.g. with respect to dimensions, weights or other performance criteria, may not be a binding guarantee but shall merely be deemed to be general product warranty information.

3.2. Warranty shall be assertible solely in case of fault on our part regarding material, workmanship and production under proper use resulting noncompliance of the product to VitrA specifications, industry allowable tolerances and quality standard such as EN 14411 and ANSI 137.1. Where warranty claims are assertible against our representatives, such parties shall be liable to the customer solely in case of fault on our part regarding material, workmanship and production under proper use resulting noncompliance of the product to VitrA specifications, industry allowable tolerances and quality standard such as EN 14411 and ANSI 137.1. If this is the case and if the conditions specified in Section 2 are satisfied, VitrA may choose to repair, replace with non-defected same or equivalent products or compensate the customer for the reduced value of the products caused by the defects in question, depending on the nature of the defect and availability of the product. In each case, no further remedies shall be available to the customer other than VitrA's. Purely optical defects (i.e. matt/gloss differences, colour shade differences, digital printing faults and thin printing stripes etc.) shall only entitle the customer to claim a reduction in value. There would not be any change for the laid products.

3.3. Any usage errors or misuse of the product by the customer including physical or chemical abuse, or negligence is evaluated as direct damages/user error and they are not covered under the product warranty.

3.4. Do not apply any adhesive material to the laid/not laid tiles, decorative or skirting tiles. Any direct damage that may occur as a result of this application is considered as a user error and VitrA is not liable for any product change or payment.

3.5. We shall solely reimburse direct damages stated above provided that such direct damages are finally awarded by a court of competent jurisdiction.

3.6. The customer is obliged to inform VitrA within 14 calendar days in writing about the products / pallets which have delivered as broken, and to keep all broken products for inspection by the technical experts authorized by VitrA. VitrA is not responsible for any changes or claims for damages if it determined by technical experts that the fracture formation is not caused by the pallet arrangement.

VitrA Garanti Koşul ve Kuralları

- 3.7. Müşteri, döşeme yapılmadan önce herhangi bir desen/rengi farklılaşması olup olmadığına dair ürünleri kontrol etmekle yükümlüdür. Ürünler döşendikten sonra, VitrA, renk farklılaşması için hiçbir koşulda sorumlu değildir. Aynı renk tonuna ve kalibreye sahip ürünler, farklı kutuları karıştırarak aynı alana döşenmemelidir. Ürünler teknik sebeplerden dolayı derzsiz döşenmemelidir. Kutu üstünde tavsiye edilen derz ölçüsü kullanılmalıdır.
- 3.8. Ürünler (duvar karosu, yer karosu, porselen, havuz parçaları ve aynalı karolar) kesinlikle tavana döşenmemelidir. Döşenmesi halinde yaşanabilecek kaza, mal veya can kaybı olaylarının doğurabileceği talep ve sonuçlardan VitrA sorumlu değildir.
- 3.9. Döşeme esnasında oluşabilecek kayıplar ve döşeme/kullanım sonrası oluşabilecek kısmi değişim ve tamirat ihtiyaçları için hesaplanan alandan yeterli kadar fazla (kullanılacak alana göre min. 2 kutu veya 100 metrekareden büyük alanlar için %2) ürün sipariş etmenizi ve ileride oluşabilecek ihtiyaçlar için saklamanızı önemle tavsiye ederiz.
- 3.10. Rektifiyeli/kalibreli ürünler, döşeme öncesinde önerilen derz aralığı ile kontrol edilmelidir. Herhangi bir yazılı şikâyetin bulunmaması veya desen takibi bulunan özel ürünlerin tavsiye edilen derz artışı ile kontrol edildikten sonra döşenmesi halinde, ürünlerin müşteri tarafından kabul edildiği ve kusursuz olduğu varsayılır.
- 3.11. Döşeme kalitesi ürün kalitesi kadar önemlidir, bu nedenle VitrA, ürünlerinden en iyi performansın alınması için döşemenin yetkin karo döşeyicileri tarafından yapılmasını önerir. Altyapı hataları, tesisat ve yalıtım kaynaklı hatalar, uygulanan sıva yeterince sertleşmeden yapılan uygulama kaynaklı hatalar, hatalı sıva kullanımı/sıva muhteviyatı kaynaklı hatalar, karoların altında uygun şekilde yapıştırıcı uygulanmaması nedeniyle oluşan kırılma/çatlamalar, yanlış döşeme ve yanlış yapıştırıcı seçimi nedeniyle ortaya çıkan hatalar VitrA'nın sorumluluğunda değildir.
- 3.12. Geniş alan uygulamalarında (6x6 m'den büyük alanlarda) yapıştırıcının elastikiyet özelliği tek başına yeterli olmamaktadır. Kaplama sürekliliği genleşme derzleri kullanılarak kesilmeli ve bu derzler yardımıyla gerilme hareketleri sönümlenmelidir. Uygulama yüzeylerinde bırakılmış yapısal genleşme (dilatasyon) derzlerine dikkat edilmeli, derzlerin üzeri kesinlikle karo ile kaplanmamalıdır. Bu uygulamaya uyulmaması neticesinde ortaya çıkabilecek direkt hasarlar kullanıcı hatası olarak kabul edilir ve VitrA herhangi bir ürün değişikliği veya ödeme yapma yükümlülüğü taşımamaktadır.
- 3.13. VitrA, duş, banyo vb. ıslak alanlara döşenen metalik dekorlar ve metalik sırlı karolar için herhangi bir garanti sunmamaktadır. Bu ürünleri temizlemek için kesinlikle aşındırıcı malzemeler ve güçlü temizlik maddeler kullanılmamalıdır. Detaylı bilgi için Temizlik ve Bakım Talimatlarına bakınız.
- 3.14. Karo üzerinde ağır lekelenmeleri önlemek için herhangi bir gıda, sıvı veya kimyasal dökülmesi durumunda karo yüzeyi derhal temizlenmelidir. Uzun süre temizlenmez ise, yabancı maddelerin karolarda hafif renk değişimi yapması mümkündür. VitrA'nın garantisi, yanlış kullanım, yanlış temizlik uygulamaları veya ihmal nedeniyle ürünün bozulmasını kapsamamaktadır.
- 3.15. VitrA, hatalı tasarım, yanlış ürün seçimi, çevre koşulları veya temizlik ve bakım talimatlarına uygun olmayan temizlikten kaynaklanan hasarlardan sorumlu değildir. Kullanılan deterjanlar kesinlikle hidroflorik asit ve türevlerini içermemelidir. Alternatif / koruyucu zemin uygulamaları kullanılıyorsa, uygulamayı doğrulamak ve ürün garantisini sunmak zemin uygulamaları üreticisinin / satıcısının sorumluluğundadır. VitrA'nın ürün önerilerinden bağımsız yapılan özel yüzey uygulamaları kaymazlık değeri, lekelenme direnci vb. gibi karo yüzey özelliklerini değiştirebilir ve bu durum VitrA'nın garanti şartlarını geçersiz kılar.
- 3.16. Uygun olmayan ürün seçimi, karolarda aşınmaya, kırılmaya, çatlamaya, kaymaya, donma hasarına vb. neden olabilir. VitrA, hatalı planlamanın veya ürünlerin yanlış kullanımının bu tür sonuçlarıyla ilgili dava, değiştirme veya yenileme taleplerinden sorumlu değildir.
- 3.17. VitrA'nın kutu, ürün veya katalog üzerinde belirttiği yazılı ya da görsel döşeme yönergelerine aykırı yapılmış döşeme işlemlerinden doğacak herhangi değiştirme veya yenileme talebinden VitrA sorumlu değildir.
- 3.18. VitrA, "Kalite: 1" olarak sınıflandırılanların dışındaki ürünler için herhangi bir garanti vermemektedir.
- 3.19. Kesme işlemi esnasında üründe meydana gelebilecek herhangi bir hasar durumunda VitrA, ürünlerin hangi ekipman kullanılarak ve hangi koşullar altında, hangi teknikle kesilebildiğini müşteriye bildirir. Anlaşmazlık halinde VitrA'nın standart kesme test sonucu ve önerisi esas alınır. VitrA, ürünlerin yanlış kullanımı veya önerilen kesme uygulaması dışındaki uygulamalar nedeniyle oluşan değiştirme veya yenileme taleplerinden sorumlu değildir.
- 3.20. VitrA, yazılı izni olmaksızın ürünlerinde fırınlanarak veya fırınlanmadan yapılan ikincil işlemlere dair garanti vermez. Örneğin: parlatma, rektifiye etme, scoring, sulu/kuru kesim, fileleme gibi işlemler sonucu oluşacak hatalar garanti kapsamı dışındadır.































* Ürünlerimizin, Garanti Koşullarının, Temizlik ve Bakım Talimatlarının yanı sıra Ürün Teknik Özellikleri ve döşeme talimatlarıyla ilgili en son bilgileri aşağıdaki web sitelerinde bulabilirsiniz:
www.vitra.com.tr / <https://vitraglobal.com/>

VitrA Terms and Warranty Conditions

- 3.7. The customer is responsible to check the goods for any variation in colour before being laid. Once the goods have been laid, VitrA is not liable under any circumstances for variations in colour. The products which have the same colour tone and calibre number should be laid to the same space by mixing different boxes. The product should not be laid without joint due to technical reasons. The recommended joint width should be used that is indicated on the boxes.
- 3.8. Products (wall tiles, floor tiles, porcelain, pool parts and mirrored tiles) should never be laid on the ceiling. VitrA is not liable for any incidents or consequences of accidents, property or loss of life that may occur as a result of laying.
- 3.9. VitrA strongly recommends ordering and storing for more than enough products from the area calculated (min. 2 boxes or 2% for areas larger than 100 square meters according to the area to be used) for the losses and the partial change and repair requirements that may occur during installation / use and keep them for future requirements.
- 3.10. Rectified / non-rectified products with pattern should be controlled with recommended joint width during before laying. In the absence of any written complaint or if the goods are laid, they are assumed to be accepted by the customer and the products are free of any defects.
- 3.11. Installation quality is as important as product quality, therefore VitrA recommends utilization of competent tile layers for the best results. VitrA does not accept any responsibility for defects aroused from infrastructure failures, faults due to installation and insulation, errors caused by application of plaster without hardening enough, application of faulty plaster / defects due to plaster content, breakage / cracking due to improper application of adhesive under tiles, incorrect flooring and wrong adhesive selection.
- 3.12. In wide area applications (in areas larger than 6x6 m), the elasticity of the adhesive alone is not sufficient. The continuity of the coating should be cut using expansion joints and the tensile movements should be damped with the help of these joints. Attention should be paid to the structural expansion (dilatation) joints left on the application surfaces and the joints should not be covered with tile. Any direct damage that may occur as a result of non-observance of this application is considered as a user error and VitrA is not liable for any product change or payment.
- 3.13. VitrA shall not accept any warranty for metallic decors and metallic glazed tiles installed in wet areas such as showers, baths etc. Never use abrasive materials and strong cleaning agents for cleaning these products. Please refer to Maintenance and Cleaning Instructions.
- 3.14. Any food, liquid or chemical spill must be cleaned away immediately to prevent harsh staining. It is possible for foreign substances to leave slight discoloration on the tiles if left unattended for prolonged time periods. VitrA's warranty does not cover deterioration to the product due to improper use, incorrect cleaning applications or gross negligence.
- 3.15. VitrA is not liable for any of the consequences of improper planning, wrong product selection, and environmental conditions or for damage caused by inappropriate cleaning that is not carried according to the maintenance and care instructions. Under any circumstances, the detergents must not contain any hydrofluoric acid and its derivatives.
- If alternative/restorative floor treatments are employed, it is the responsibility of the floor treatment manufacturer/seller to verify compatibility and offer product warranty. Some treatments may alter the tile surface characteristics such as anti-slip resistance, staining resistance etc. which might be inconsistent with VitrA's product recommendations and VitrA's warranty does not cover this situation.
- 3.16. Inappropriate product selection may cause abrasion, breakage, crack, slipperiness, frost damage etc. on the tiles. VitrA is not liable for lawsuit, replacement or renovation claims regarding these kind of consequences of improper planning or misuse of the products.
- 3.17. VitrA is not responsible for any replacement or renewal request arising from laying procedures that are in contradiction with VitrA's written or visual laying guidelines specified on the box, product or catalogue.
- 3.18. VitrA shall not accept any warranty for products other than those classified as "Quality: 1".
- 3.19. In the event of any damage to the product during the cutting process, VitrA informs the customer about the conditions of cutting, which equipment can be used and cutting techniques. In the event of a dispute, VitrA's standard cutting test result and recommendation of VitrA are taken into consideration. VitrA is not responsible for any replacement or replacement requests caused by improper use of the products or applications other than the recommended cutting application.
- 3.20. VitrA shall assume no warranty for any additional secondary application with refiring or without refiring such as polishing, rectification, scoring, wet/dry cutting, netting without written approval.

* You can find most recent information about our products, Warranty Conditions, Maintenance and Cleaning Instructions, along with other Product Performance Data and Installation specifications at:
www.vitra.com.tr / <https://vitraglobal.com/>

Semboller / Symbols

 Yer Karosu Floor Tile	 Duvar Karosu Wall Tile	 Dona Dayanım Frost Resistant	 Ödüllü Award Winning	 Yeni Novelty	 Ticari Alan Commercial Areas	 Dış Cephe Facade	 Konut Residential	 Endüstriyel Alan Industrial Area
 Mat Matt	 Parlak Glossy	 Honed Touch	 Cam Glass	 Reaktif Ink Reactive Ink	 Rektifiyeli Rectified	 Rektifiyesiz Non Rectified	 Havuz Çevresi Pool Surrounding	 Porselen Porcelain
 Desen Farklılaşması Shade Variation	 Desen Farklılaşması Shade Variation	 Desen Farklılaşması Shade Variation	 Desen Farklılaşması Shade Variation	 Desen Farklılaşması Shade Variation	 Full Lappato	 Lappato	 Dekor Baskı	 Metalik Sır
 Küçük Ebat Mini Size	 Modülerlik Modularity	 20 mm	 PEI1	 PEI2	 PEI3	 PEI4	 PEI5	

reaLook TECHNOLOGY

(1) Dünyanın en ileri baskı olanakları Vitra'nın üstün tasarım yetkinliği ile birleşiyor. Vitra'ya özgü reaLook baskı teknolojisi ile görüntüler, karo üzerinde, doğala en yakın dokularla ve görsellikle yansıtılıyor.

World's most advanced printing facilities are combined with Vitra's exquisite design competence. With Vitra's exclusive reaLook printing technology, images can be reflected on the tiles in such a way that they are indistinguishable from natural.

(1) Sadece ilgili ülke mevzuatında gerekliyse / Only if required by corresponding national statutory regulations

Ürün Kodları / Product Codes

Yeni Ürün Kodu / New Product Code	Eski Ürün Kodu / Previous Product Code	Açıklama / Description
ATTRACTION		
K932213LPR001VTE0	K932213LPR	M60X60 ATTRACTION WHITE LPR
K920210R0001VTE0	K920210R	M25X70W ATTRACTION WHITE GLOSSY
K920232R0001VTE0	K920232R	M25X70W ATTRACTION WHITE DEC GLOSSY
BERN		
K947049R0001VTS0	K947049R	M40X80W BERN GREY GLOSSY REC
K947050R0001VTS0	K947050R	M40X80W BERN DARK GREY GLOSSY REC
K947051R0001VTS0	K947051R	M40X80W BERN GREY DEKOR GLOSSY REC
K947052R0001VTS0	K947052R	M40X80W BERN DARK GREY DEKOR GLOSSY REC
K946220R0001VTE0	K946220FCPR	60X60 BERN GREY FCPR
K946221R0001VTE0	K946221FCPR	60X60 BERN D.GREY FCPR
B&W STAR L		
K945178R0001VTE0	K945178R	25X70W B&W STAR WHITE GLS
K945179R0001VTE0	K945179R	25X70W B&W STAR WHITE DEC GLS REC
K945180R0001VTE0	K945180R	25X70W B&W STAR BLACK GLS REC
K945181R0001VTE0	K945181R	25X70W B&W STAR BLACK GLS DEC REC
B&W STAR XL		
K943661R0001VTS0	K943661R	40X80W B&W STAR WHITE GLS
K944011R0001VTS0	K944011R	40X80W B&W STAR WHITE-BLACK CHEQ DEC GLS
K944012R0001VTS0	K944012R	40X80W B&W STAR BLACK GLS
BLACK SWAN		
K94500200001VTE0	K945002	33X33 BLACK SWAN BEIGE MATT
BLACK SWAN		
K94500300001VTE0	K945003	33X33 BLACK SWAN MINK MATT
K94500400001VTE0	K945004	33X33 BLACK SWAN GREY MATT
K94500500001VTE0	K945005	33X33 BLACK SWAN MIX 1 DEC MATT
BLAST		
K93588600001VTE0	K935886	M45X45 BLAST GREY MATT
K93589000001VTE0	K935890	M45X45 BLAST WHITE MATT
K08001500001VTE0	K080015	M30X60W BLAST GREY DEC
K08064500001VTE0	K080645	M30X60W BLAST WHITE DEC
K92030200001VTE0	K920302	M30X60W BLAST GREY
K92132600001VTE0	K921326	M30X60W BLAST WHITE
BLOOM		
K94089300001VTE0	K940893	M33X33 BLOOM CREAM MATT
K94090400001VTE0	K940904	M33X33 BLOOM WHITE MATT
K94219000001VTE0	K942190	M33X33 BLOOM MINK MATT
K94220100001VTE0	K942201	M33X33 BLOOM ANTHRACITE MATT
K06381200001VTE0	K063812	14X60W BLOOM BRD 1 ANTHRACITE
K06382300001VTE0	K063823	14X60W BLOOM BRD 1 MINK
K06383400001VTE0	K063834	14X60W BLOOM BRD 2 ANTHRACITE
K06384500001VTE0	K063845	14X60W BLOOM BRD 2 MINK
K94333200001VTE0	K943332	8X33 BLOOM ANTHRACITE PLTH MATT

Ürün Kodları / Product Codes

Yeni Ürün Kodu / New Product Code	Eski Ürün Kodu / Previous Product Code	Açıklama / Description
K94334300001VTEo	K943343	8X33 BLOOM CREAM PLTH MATT
K91345300001VTEo	K913453	M85x45 BLOOM ANTHRACITE PLTH
K91343100001VTEo	K913431	M85x45 BLOOM WHITE PLTH
K91344200001VTEo	K913442	M85x45 BLOOM CREAM PLTH
K91346400001VTEo	K913464	M85x45 BLOOM MINK PLTH
K94336500001VTEo	K943365	M8X33 BLOOM WHITE PLTH MATT
K94335400001VTEo	K943354	M8X33 BLOOM MINK PLTH MATT
K88999400001VTEo	K889994	M45X45 BLOOM WHITE
K89000500001VTEo	K890005	M45X45 BLOOM CREAM
K89001600001VTEo	K890016	M45X45 BLOOM ANTHRACITE
K89002000001VTEo	K890020	M45X45 BLOOM MINK
K07754300001VTEo	K077543	M20X50W BLOOM MINK DEC GLSY
K0775400001VTEo	K07754	M20X50W BLOOM ANTHRACITE DEC GLSY
K90468100001VTEo	K904681	M20X50W BLOOM WHITE
K90469200001VTEo	K904692	M20X50W BLOOM CREAM
K90470300001VTEo	K904703	M20X50W BLOOM ANTHRACITE
K90471400001VTEo	K904714	M20X50W BLOOM MINK
K06377500001VTEo	K063775	30X60W BLOOM DEC ANTHRACITE
K06378600001VTEo	K063786	30X60W BLOOM DEC MINK
K06379000001VTEo	K063790	30X60W BLOOM DEC WHITE
K06380100001VTEo	K063801	30X60W BLOOM DEC CREAM
K88358000001VTEo	K883580	M30X60W BLOOM ANTRASIT
K88359100001VTEo	K883591	M30X60W BLOOM WHITE
K88360200001VTEo	K883602	M30X60W BLOOM MINK
K88361300001VTEo	K883613	M30X60W BLOOM CREAM
CELEBRATION		
K945027R0001VTEo	K945027FCPR	M60X60 CELEBRATION CREAM FCPR
K945026R0001VTEo	K945026FCPR	M60X60 CELEBRATION MINK FCPR
K932224LPR01VTEo	K932224LPR	M60X60 CELEBRATION CREAM LPR
K933871LPR01VTEo	K933871LPR	M60X60 CELEBRATION MINK LPR
K080472R0001VTEo	K080472R	M25X70W CELEBRATION GOLD DEC 1
K080483R0001VTEo	K080483R	M25X70W CELEBRATION GOLD DEC 2 LINES
K920173R0001VTEo	K920173R	M25X70W CELEBRATION ANTRASITE GLOSSY
K920184R0001VTEo	K920184R	M25X70W CELEBRATION MINK GLOSSY
K920206R0001VTEo	K920206R	M25X70W CELEBRATION CREAM GLOSSY
K920862R0001VTEo	K920862R	M25X70W CELEBRATION MINK DEC 1
CELEBRATION S		
K94540300001VTEo	K945403	75X25W CELEBRATION CREAM BULL GLS
K94540400001VTEo	K945404	75X25W CELEBRATION MINK BULL GLS
K94540700001VTEo	K945407	45X45 CELEBRATION CREAM MATT
K94540900001VTEo	K945409	45X45 CELEBRATION MINK MATT
K94539900001VTEo	K945399	25X40W CELEBRATION CREAM GLS
K94540000001VTEo	K945400	25X40W CELEBRATION MINK GLS
CEMENT-TECH S		
K94554900001VTEo	K945549	M45X45 CEMENT-TECH ANTRACITE R9

Yeni Ürün Kodu / New Product Code	Eski Ürün Kodu / Previous Product Code	Açıklama / Description
K9455500001VTEo	K945550	M45X45 CEMENT-TECH WHITE R9
K94555100001VTEo	K945551	M45X45 CEMENT-TECH GREY R9
K94538000001VTEo	K945380	25X40W CEMENT TECH WHITE GEO DEC MATT
K94538100001VTEo	K945381	25X40W CEMENT TECH GREY GEO DEC MATT
K94538200001VTEo	K945382	25X40W CEMENT TECH ANTHRACITE GEO DEC
K94538600001VTEo	K945386	25X40W CEMENT TECH WHITE MATT
K94538700001VTEo	K945387	25X40W CEMENT TECH GREY MATT
K94538800001VTEo	K945388	25X40W CEMENT TECH ANTHRACITE MATT
CLAYART		
K946262R0001VTSO	K946262R	33X100W CLAYART GREY MATT REC
K946264R0001VTSO	K946264R	33X100W CLAYART PLASTER DEC GREY MATT
K946644R0001VTSO	K946644R	33X100W CLAYART WHITE MATT REC
K946645R0001VTSO	K946645R	33X100W CLAYART PLASTER DEC WHITE MATT R
COSY		
K94462300001VTEo	K944623	25X40W COSY CREAM MATT
K94462400001VTEo	K944624	25X40W COSY CREAM LWAVE DEC MATT
K94462600001VTEo	K944626	25X40W COSY GREY LWAVE DEC MATT
K94467400001VTEo	K944674	25X40W COSY GREY MATT
K94467500001VTEo	K944675	25X40W COSY BASALT MATT
K94467600001VTEo	K944676	25X40W COSY BROWN MATT
K94467700001VTEo	K944677	25X40W COSY WHITE MATT
K94467800001VTEo	K944678	25X40W COSY BASALT LWAVE DEC MATT
K94467900001VTEo	K944679	25X40W COSY BROWN LWAVE DEC MATT
K94468000001VTEo	K944680	25X40W COSY WHITE LWAVE DEC MATT
CRAFTMIX		
K94365500001VTEo	K943655	2X30W CRAFTMIX GREY BRD GLS
K94365300001VTEo	K943653	2X30W CRAFTMIX CREAM BRD GLS
K94365200001VTEo	K943652	2X30W CRAFTMIX SAND BRD GLOSSY
K94365700001VTEo	K943657	2X30W CRAFTMIX BLUE BRD GLOSSY
K94362800001VTEo	K943628	30X60W CRAFTMIX SAND GLOSSY
K94362900001VTEo	K943629	30X60W CRAFTMIX CREAM GLOSSY
K94363100001VTEo	K943631	30X60W CRAFTMIX GREY GLOSSY
K94363200001VTEo	K943632	30X60W CRAFTMIX BLUE GLOSSY
K94363500001VTEo	K943635	30X60W CRAFTMIX CREAM SCRDR REGPATCH
K94363600001VTEo	K943636	30X60W CRAFTMIX CREAM SCRDR ARTIS PATCH
K94363700001VTEo	K943637	30X60W CRAFTMIX SAND SCRDR REG PATCH DEC
K94363800001VTEo	K943638	30X60W CRAFTMIX SAND SCRDR ART PATCH DEC
K94363900001VTEo	K943639	30X60W CRAFTMIX BLUE SCRDR REG PATCH DEC
K94364000001VTEo	K943640	30X60W CRAFTMIX BLUE SCRDR ART PATC DEC
K94364100001VTEo	K943641	30X60W CRAFTMIX D.MINK SCRDR REG PATC DEC
K94364200001VTEo	K943642	30X60W CRAFTMIX D.MINK SCRDR ART PATC DEC
DECOCREAM		
K94371700001VTEo	K943717	30X60W DECOCREAM CREAM GLOSSY
K94371800001VTEo	K943718	30X60W DECOCREAM WARM GREY GLOSSY
K94372700001VTEo	K943727	30X60W DECOCREAM CREAM LARGE SHLTR 3D

Ürün Kodları / Product Codes

Yeni Ürün Kodu / New Product Code	Eski Ürün Kodu / Previous Product Code	Açıklama / Description
K94373600001VTE0	K943736	30X60W DECOCREAM W.GREY LARGE SHLTR 3D
K945167R0001VTE0	K945167R	M30X60W ECCENTRIC GREY GLOSSY REC
K945165R0001VTE0	K945165R	M30X60W ECCENTRIC WHITE GLOSSY REC
K945166R0001VTE0	K945166R	M30X60W ECCENTRIC BONE GLOSSY REC
K945168R0001VTE0	K945168R	M30X60W ECCENTRIC WHITE DEC GLOSSY REC
K945169R0001VTE0	K945169R	M30X60W ECCENTRIC BONE DEC GLOSSY REC
K945170R0001VTE0	K945170R	M30X60W ECCENTRIC GREY DEK GLOSSY REC
ECCENTRIC M		
K357023R0001VTE0	K357023FCPR	M60X60 ECCENTRIC WHITE FCPR
K357024R0001VTE0	K357024FCPR	M60X60 ECCENTRIC GRI FCPR
K357025R0001VTE0	K357025FCPR	M60X60 ECCENTRIC BONE FCPR
K945165R0001VTE0	K945165R	M30X60W ECCENTRIC WHITE GLOSSY REC
K945166R0001VTE0	K945166R	M30X60W ECCENTRIC BONE GLOSSY REC
K945167R0001VTE0	K945167R	M30X60W ECCENTRIC GREY GLOSSY REC
K945168R0001VTE0	K945168R	M30X60W ECCENTRIC WHITE DEC GLOSSY REC
K945169R0001VTE0	K945169R	M30X60W ECCENTRIC BONE DEC GLOSSY REC
K945170R0001VTE0	K945170R	M30X60W ECCENTRIC GREY DEK GLOSSY REC
DÜZ RENKLER		
K94775100001VTE0	K230110000	M20X20W RELIEF WHITE GLOSSY
K94775200001VTE0	K240040000	M20X25W WHITE GLOSSY
K94775000001VTE0	K240120001	M20X25W WHITE MATT
K770324B0001VTE0	K770324B	20X30W WHITE GLOSSY BLOCK
K770943B0001VTE0	K770943B	20X30W WHITE RELIEF GLOSSY BLOCK
K777103B0001VTE0	K777103B	20X30W WHITE SATIN MATT BLOCK
K77032400001VTE0	K770324	M20X30W WHITE GLOSSY
K77094300001VTE0	K770943	M20X30W RELIEF WHITE GLOSSY
K77710300001VTE0	K777103	M20X30W SATEN WHITE
K86914400001VTE0	K869144	M20X50W WHITE MATT
K87021600001VTE0	K870216	M20X50W WHITE GLOSSY
K870216B0001VTE0	K870216B	M20X50W WHITE GLOSSY BLOCK
K92843300001VTE0	K928433	M20X60W WHITE MATT
K928433B0001VTE0		M20X60D WHITE MATT BLOCK
K92842200001VTE0	K928422	M20X60W WHITE GLSY
K928422B0001VTE0		M20X60D WHITE PRL BLOCK
K816295B0001VTE0	K816295B	25X40 WHITE GLOSSY BLOCK
K822412B0001VTE0	K822412B	25X40W WHITE SATIN MATT BLOCK
K81629500001VTE0	K816295	M25X40W WHITE GLOSSY
K82241200001VTE0	K822412	M25X40W SATEN WHITE
K86739400001VTE0	K867394	M25X40W BLACK GLOSSY
K912554R0001VTE0	K912554R	M25X70W WHITE MATT REC
K82305300001VTE0	K823053	M30X60W WHITE GLOSSY N.REC
K823053B0001VTE0	K823053B	M30X60W WHITE GLOSSY N.REC BLOCK
K82304200001VTE0	K823042	M30X60W SATIN WHITE N.REC
K823053R0001VTE0	K823053R	M30X60W WHITE GLOSSY REC
K823042B0001VTE0	K823042B	M30X60W SATIN WHITE N.REC BLK

Yeni Ürün Kodu / New Product Code	Eski Ürün Kodu / Previous Product Code	Açıklama / Description
K823042R0001VTE0	K823042R	M30X60W SATIN WHITE REC
ELEGANT		
K93203600001VTE0	K932036	75X25W ELEGANT BULL MOCHA
K83231400001VTE0	K832314	M45X45 ELEGANT MOCA
K83232500001VTE0	K832325	M45X45 ELEGANT CREAM
K83235100001VTE0	K832351	M45X45 ELEGANT ANTRASIT
K83236200001VTE0	K832362	M45X45 ELEGANT WHITE
K83227000001VTE0	K832270	M25X40W ELEGANT MOCHA
K83228100001VTE0	K832281	M25X40W ELEGANT CREAM
K83229200001VTE0	K832292	M25X40W ELEGANT ANTRASIT
K83230300001VTE0	K832303	M25X40W ELEGANT WHITE
K84068100001VTE0	K840681	M25X40W ELEGANT WHITE SCRD
K84069200001VTE0	K840692	M25X40W ELEGANT CREAM SCRD
K84076200001VTE0	K840762	M25X40W ELEGANT ANTRASIT SCRD
K84077300001VTE0	K840773	M25X40W ELEGANT MOCHA SCRD
ETHEREAL M		
K928094LPR01VTE0	K928094LPR	M60X60 ETHEREAL LBEIGE LPR
K928061LPR01VTE0	K928061LPR	M60X60 ETHEREAL LGREY LPR
K928072LPR01VTE0	K928072LPR	M60X60 ETHEREAL GREY LPR
K94434600001VTE0	K944346	9X60W ETHEREAL GOLD GEO BRD LBEIGE GLS
K94434700001VTE0	K944347	9X60W ETHEREAL GOLD GEO BRD BROWN GLS
K94434800001VTE0	K944348	9X60W ETHEREAL PLATIN GEO BRD LGREY GLS
K94434900001VTE0	K944349	9X60W ETHEREAL PLATIN GEO BRD GREY GLS
K94106600001VTE0	K941066	M45X45 ETHEREAL LBEIGE FLAT MATT
K94107000001VTE0	K941070	M45X45 ETHEREAL LGREY FLAT MATT
K94108100001VTE0	K941081	M45X45 ETHEREAL GREY FLAT MATT
K94109200001VTE0	K941092	M45X45 ETHEREAL BROWN FLAT MATT
K93963300001VTE0	K939633	M30X60W ETHEREAL SCORED SBROWN (5 LINE)
K93969200001VTE0	K939692	M30X60W ETHEREAL SCORED LGREY (5 LINE)
K08222200001VTE0	K082222	30X60W ETHEREAL PLATIN GEO DEC LGREY GL
K08223300001VTE0	K082233	30X60W ETHEREAL PLATIN GEO DEC GREY GLSY
K08225500001VTE0	K082255	30X60W ETHEREAL GOLD GEO DEC LBEIGE GLS
K08226600001VTE0	K082266	30X60W ETHEREAL GOLD GEO DEC SOFT BROWN
K92778100001VTE0	K927781	M30X60W ETHEREAL LGREY GLSY
K92779200001VTE0	K927792	M30X60W ETHEREAL GREY GLSY
K92781400001VTE0	K927814	M30X60W ETHEREAL LBEIGE GLSY
K92782500001VTE0	K927825	M30X60W ETHEREAL SOFT BROWN GLSY
K92784000001VTE0	K927840	M30X60W ETHEREAL LGREY 3D DEC GLSY
K92787300001VTE0	K927873	M30X60W ETHEREAL LBEIGE 3D DEC GLSY
K92793200001VTE0	K927932	M30X60W ETHEREAL LBEIGE GEO DEC GLSY
K92794300001VTE0	K927943	M30X60W ETHEREAL SOFT BROWN GEO DEC GLSY
K92796500001VTE0	K927965	M30X60W ETHEREAL BROWN- LBEIGE GEO MIX
K92797600001VTE0	K927976	M30X60W ETHEREAL GREY GEO MIX
K92804600001VTE0	K928046	M30X60W ETHEREAL BROWN- LBEIGE LINES MI
K92805000001VTE0	K928050	M30X60W ETHEREAL GREY LINES MIX

Ürün Kodları / Product Codes

Yeni Ürün Kodu / New Product Code	Eski Ürün Kodu / Previous Product Code	Açıklama / Description
K93962200001VTEo	K939622	M30X60W ETHEREAL SCORED GREY G. (5LINE)
ETHEREAL XS		
K94460200001VTEo	K944602	M33X33 ETHEREAL LGREY FLAT MATT
K94460700001VTEo	K944607	M33X33 ETHEREAL SAND GREY FLAT MAT
K94461600001VTEo	K944616	M20X25W ETHEREAL LGREY GLS
K94461800001VTEo	K944618	M20X25W ETHEREAL SAND GREY GLOSSY
FUTURA M		
K94417200001VTEo	K944172	M30X60D FUTURA 3D BEYAZ DEK MAT
K94421600001VTEo	K944216	K94421600001VTEo M30X60D FUTURA BEYAZ MAT
K94697600001VTEo	K946976	K94697600001VTEo M30X60D FUTURA ANTRASIT MAT
K94697700001VTEo	K946977	M30X60D FUTURA 3D ANTRASIT DEK MAT
FUTURA XL		
K937964R0001VTSO	K937964R	M33X100W FUTURA 3D WHITE DEC MATT REC
K939294R0001VTSO	K939294R	M33X100W FUTURA WHITE MATT REC
HANDCRAFTED		
K94497500001VTEo	K944975	30X60W HANDCRAFTED BEIGE MATT
K94497700001VTEo	K944977	30X60W HANDCRAFTED BEIGE 3D DEC MATT
K94619400001VTEo	K946194	30X60W HANDCRAFTED GREY MATT
K94619500001VTEo	K946195	30X60W HANDCRAFTED GREY 3D DEC MATT
HOMEMADE		
K94358100001VTEo	K943581	M10X30W HOMEMADE SAND CLAS FRM GLOSSY
K94358200001VTEo	K943582	M10X30W HOMEMADE SAND REG FRM GLOSSY
K94358400001VTEo	K943584	M10X30W HOMEMADE SAND GLOSSY
K94358800001VTEo	K943588	M10X30W HOMEMADE CREAM CLAS FRM GLOSSY
K94358900001VTEo	K943589	M10X30W HOMEMADE CREAM REG FRAME GLOSSY
K94359200001VTEo	K943592	M10X30W HOMEMADE CREAM GLOSSY
K94360200001VTEo	K943602	M10X30W HOMEMADE GREY CLAS FRAME GLOSSY
K94360300001VTEo	K943603	M10X30W HOMEMADE GREY REG FRAME GLOSSY
K94360500001VTEo	K943605	M10X30W HOMEMADE GREY GLOSSY
K94388200001VTEo	K943882	M10X30W HOMEMADE POWDER CLAS FRM GLOSSY
K94388300001VTEo	K943883	M10X30W HOMEMADE POWDER REG FRM GLOSSY
K94388500001VTEo	K943885	M10X30W HOMEMADE POWDER GLOSSY
HOMEMADE X		
K94664600001VTEo	K946646	10X30W HOMEMADE-X BRONZE MATT
K94630300001VTEo	K946303	10X30W HOMEMADE-X SAPPHIRE BLUE GLS
K94630400001VTEo	K946304	10X30W HOMEMADE-X EMERALD GREEN GLS
K94630500001VTEo	K946305	10X30W HOMEMADE-X WHITE GLS
K94630600001VTEo	K946306	10X30W HOMEMADE-X FRAME DEC S.BLUE GLS
K94630700001VTEo	K946307	10X30W HOMEMADE-X FRAME DEC E.GREEN GLS
K94630800001VTEo	K946308	10X30W HOMEMADE-X FRAME DEC WHITE GLS
ICE & SMOKE S		
K94545700001VTEo	K945457	75X25W ICEANDSMOKE ICE GREY BULL MATT
K94545600001VTEo	K945456	75X25W ICEANDSMOKE SMOKE GREY BULL MATT
K94425600001VTEo	K944256	M45X45 ICEANDSMOKE ICE GREY R9
K94425700001VTEo	K944257	M45X45 ICEANDSMOKE SMOKE GREY R9

Yeni Ürün Kodu / New Product Code	Eski Ürün Kodu / Previous Product Code	Açıklama / Description
K94494300001VTEo	K944943	25X40W ICEANDSMOKE ICE GREY GEO DEC MATT
K94494400001VTEo	K944944	25X40W ICEANDSMOKE ICE GREY MATT
K94494500001VTEo	K944945	25X40W ICEANDSMOKE GREY GEO DEC MATT
K94494600001VTEo	K944946	25X40W ICEANDSMOKE GREY MATT
INSIDE S		
K94500700001VTEo	K945007	M45X45 INSIDE GREY MATT
K94500800001VTEo	K945008	M45X45 INSIDE SAND MATT
K94494700001VTEo	K944947	25X40W INSIDE GREY LWAVE DEC GLOSSY
K94494800001VTEo	K944948	25X40W INSIDE GREY GLOSSY
K94494900001VTEo	K944949	25X40W INSIDE SAND LWAVE DEC GLOSSY
K94495000001VTEo	K944950	25X40W INSIDE SAND GLOSSY
INSIDE M		
K357022R0001VTEo	K357022FCPR	M60X60 INSIDE GREY FCPR
K357021R0001VTEo	K357021FCPR	M60X60 INSIDE SAND FCPR
K357026R0001VTEo	K357026FCPR	M60X60 INSIDE VIZON FCPR
K94519300001VTEo	K945193	M30X60W INSIDE GREY GLOSSY
K94519400001VTEo	K945194	M30X60W INSIDE GREY DEC GLS
K94519600001VTEo	K945196	M30X60W INSIDE SAND DEC GLS
K94457200001VTEo	K944572	M30X60W INSIDE SAND GLSY
INSIDE XL		
K928982FLPR1VTEo	K928982FLPR	M60X60 INSIDE GREY FLPR
K928971FLPR1VTEo	K928971FLPR	M60X60 INSIDE SAND FLPR
K928993FLPR1VTEo	K928993FLPR	M60X60 INSIDE MINK FLPR
K928886R0001VTSO	K928886R	M33X100W INSIDE SAND GLSY
K928890R0001VTSO	K928890R	M33X100W INSIDE GREY GLSY
K928901R0001VTSO	K928901R	M33X100W INSIDE MINK GLSY
K928912R0001VTSO	K928912R	M33X100W INSIDE SAND PANEL DEC GLSY
K928923R0001VTSO	K928923R	M33X100W INSIDE GREY PANEL DEC GLS
K928934R0001VTSO	K928934R	M33X100W INSIDE MINK PANEL DEC GLSY
LIMESTAR		
K94380200001VTEo	K943802	M30X60W LIMESTAR L. CREAM MATT
K94380500001VTEo	K943805	M30X60W LIMESTAR L. GREY MATT
K94381200001VTEo	K943812	M30X60W LIMESTAR CREAM RELIEF DEC2 MATT
K94381700001VTEo	K943817	M30X60W LIMESTAR GREY RELIEF DEC2 MATT
LUGANO		
K947034R0001VTSO	K947034R	M40X80W LUGANO WHITE GLS REC
K947035R0001VTSO	K947035R	M40X80W LUGANO WHITE DEC GLS REC
K947036R0001VTSO	K947036R	M40X80W LUGANO GREY GLS REC
K947037R0001VTSO	K947037R	M40X80W LUGANO GREY DEC GLS REC
K947038LPR01VTEo	K947038LPR	60X60 LUGANO WHITE LPR 7REC
K947039LPR01VTEo	K947039LPR	60X60 LUGANO GREY LPR 7REC
METAL BORDER		
K04626600001VTEo	K046266	15X60W SILVER METAL BRD GLOSSY
K35699700001VTEo	K356997	1X100W COPPER LINE BORDER
K080715R0001VTEo	K080715R	3x70W SILVER STRIPE BRD MATT REC

Ürün Kodları / Product Codes

Yeni Ürün Kodu / New Product Code	Eski Ürün Kodu / Previous Product Code	Açıklama / Description
K080494R0001VTE0	K080494R	3x70W SILVER STRIPE BRD GLSY REC
K9436890001VTE0	K943689	3X80 METAL BORDUR GOLD PATINA
K9436900001VTE0	K943690	3X80 METAL BORDUR COPPER PATINA
K9436880001VTE0	K943688	3X80 METAL BORDUR SILVER PATINA
K3570060001VTE0	K357006	4X60W GOLD RESIN BORDER
METAMARMO		
K945021FLPR1VTE0	K945021FLPR	M60X60 METAMARMO CREM FLPR
K945020LPR01VTE0	K945020LPR	M60X60 METAMARMO CREAM LPR
K944709R0001VTS0	K944709R	33X100W METAMARMO 3D LWAVE DEC CREAM GL
K944996R0001VTS0	K944996R	33X100W METAMARMO CREAM GLS REC
K944998R0001VTS0	K944998R	33X100W METAMARMO PLAIN WHITE GLS REC
K944999R0001VTS0	K944999R	33X100W METAMARMO SWAVE DEC WHITE GLS R
K945000R0001VTS0	K945000R	33X100W METAMARMO BLUE GLS REC
K945078R0001VTS0	K945078R	33X100W METAMARMO 3D LWAVE DEC BLUE GLS
K3570160001VTE0	K357016	4x33W METAMARMO COPPER GLS BORDER
MILERA		
K947040R0001VTS0	K947040R	M40X80W MILERA WHITE MATT REC
K947041R0001VTS0	K947041R	M40X80W MILERA WHITE DEC MATT REC
K947042R0001VTS0	K947042R	M40X80W MILERA GREY MATT REC
K947043R0001VTS0	K947043R	M40X80W MILERA GREY DEC MATT REC
K947045LPR01VTE0	K947045LPR	60X60 MILERA WHITE LPR 7REC
K947044LPR01VTE0	K947044LPR	60X60 MILERA GREY LPR 7REC
MILLENIUM		
K0834710001VTE0	K083471	10X60W MILLENIUM GOLD BRD MATT
K0834820001VTE0	K083482	10X60W MILLENIUM PLATIN BRD MATT
K0834450001VTE0	K083445	30X60W MILLENIUM GOLD WAVY DEC MATT
K0834560001VTE0	K083456	30X60W MILLENIUM PLATIN WAVY DEC MATT
K9273720001VTE0	K927372	M30X60W MILLENIUM WHITE
K9274310001VTE0	K927431	M30X60W MILLENIUM WHITE WAVY DEC
K9304410001VTE0	K930441	M30X60W MILLENIUM LMINK
K9304520001VTE0	K930452	M30X60W MILLENIUM LMINK WAVY DEC
OPALINE		
K945076LPR01VTE0	K945076LPR	M60X60 OPALINE GREY LPR
K945077LPR01VTE0	K945077LPR	M60X60 OPALINE CREAM LPR
K945051R0001VTE0	K945051R	M25X70W OPALINE CREAM GLS REC
K945052R0001VTE0	K945052R	M25X70W OPALINE GREY GLS REC
K945053R0001VTE0	K945053R	M25X70W OPALINE KREM 3D DEC GLS REC
K945054R0001VTE0	K945054R	M25X70W OPALINE GREY 3D DEC GLS REC
K945055R0001VTE0	K945055R	M25X70W OPALINE KREM H.COMB DEC GLS REC
K945056R0001VTE0	K945056R	M25X70W OPALINE GREY H.COMB DEC GLS REC
K945057R0001VTE0	K945057R	M25X70W OPALINE CREAM GOLD DEC GLS REC
K945058R0001VTE0	K945058R	M25X70W OPALINE GRI PLATIN DEC GLS REC
K945080R0001VTE0	K945080R	M25X70W OPALINE KREM LINE DEC GLS REC
K945081R0001VTE0	K945081R	M25X70W OPALINE GREY LINE DEC GLS REC
K357015R0001VTE0	K357015R	M5x70W OPALINE GREY PLATIN BORDER GLS RE
K357014R0001VTE0	K357014R	M5x70W OPALINE CREAM GOLD BORDER GLS REC
PANGA		

Yeni Ürün Kodu / New Product Code	Eski Ürün Kodu / Previous Product Code	Açıklama / Description
K84629200001VTEo	K846292	33X33 PANGA WHITE
K84633600001VTEo	K846336	33X33 PANGA LGREY
K88245500001VTEo	K882455	M25X40W PANGA LGREY
K88247000001VTEo	K882470	M25X40W PANGA WHITE
PEARLART		
K946248R0001VTSO	K946248R	33X100W PEARLART BRONZE MATT REC
K946247R0001VTSO	K946247R	33X100W PEARLART PEARL MATT REC
K946268R0001VTSO	K946268R	33X100W PEARLART HEXAGON DEC PEARL MATT
K946643R0001VTSO	K946643R	33X100W PEARLART HEXAGON DEC BRONZE MATT
PIETRA PIENZA S		
K92271500001VTEo	K922715	M45X45 PIETRA PIENZA BEIGE 9MM
K92272600001VTEo	K922726	M45X45 PIETRA PIENZA LGREY 9MM
K92273000001VTEo	K922730	M45X45 PIETRA PIENZA D.GREY 9MM
K92274100001VTEo	K922741	M45X45 PIETRA PIENZA ANTHRACITE 9MM
K94495100001VTEo	K944951	25X40W PIETRA PIENZA LGREY LINE DEC MAT
K94495200001VTEo	K944952	25X40W PIETRA PIENZA LGREY MATT
K94495400001VTEo	K944954	25X40W PIETRA PIENZA ANTHRACITE LINE DEC
K94495500001VTEo	K944955	25X40W PIETRA PIENZA ANTHRACITE MATT
K94495700001VTEo	K944957	25X40W PIETRA PIENZA BEIGE LINE DEC MATT
K94495800001VTEo	K944958	25X40W PIETRA PIENZA BEIGE MATT
K94496000001VTEo	K944960	25X40W PIETRA PIENZA D.GREY LINE DEC MAT
K94496100001VTEo	K944961	25X40W PIETRA PIENZA D.GREY MATT
PROVENCE		
K082524R0001VTSO	K082524R	33X100W PROVENCE WHITE FLORAL GOLD DEC
K082546R0001VTSO	K082546R	33X100W PROVENCE GREIGE FLORAL GOLD DEC
K082561R0001VTSO	K082561R	33X100W PROVENCE WHITE GEOMETRIC GOLD D
K082583R0001VTSO	K082583R	33X100W PROVENCE GREIGE GEOMETRIC GOLD D
K929601R0001VTSO	K929601R	M33X100W PROVENCE WHITE
K929623R0001VTSO	K929623R	M33X100W PROVENCE GREIGE
K929645R0001VTSO	K929645R	M33X100W PROVENCE WHITE FLORAL DEC
K929660R0001VTSO	K929660R	M33X100W PROVENCE GREIGE FLORAL DEC
K929682R0001VTSO	K929682R	M33X100W PROVENCE WHITE LINES DEC
K929704R0001VTSO	K929704R	M33X100W PROVENCE GREIGE LINES DEC
K929726R0001VTSO	K929726R	M33X100W PROVENCE WHITE GEOMETRIC DEC
K929741R0001VTSO	K929741R	M33X100W PROVENCE GREIGE GEOMETRIC DEC
K929763R0001VTEo	K929763R	11X33W PROVENCE WHITE BRD 1
K929800R0001VTEo	K929800R	11X33W PROVENCE WHITE FLORAL BRD 2
K082642R0001VTEo	K082642R	11X33W PROVENCE FLORAL GOLD WHITE BRD 2
K082664R0001VTEo	K082664R	11X33W PROVENCE FLORAL GOLD GREIGE BRD 2
K082605R0001VTEo	K082605R	11X33W PROVENCE GOLD WHITE BRD 1
K082620R0001VTEo	K082620R	11X33W PROVENCE GOLD GREIGE BRD 1
K929785R0001VTEo	K929785R	11X33W PROVENCE GRIEGE BRD 1
K929822R0001VTEo	K929822R	11X33W PROVENCE GRIEGE FLORAL BRD 2
K929881R0001VTEo	K929881R	15X33W PROVENCE WHITE PLTH

Ürün Kodları / Product Codes

Yeni Ürün Kodu / New Product Code	Eski Ürün Kodu / Previous Product Code	Açıklama / Description
K929903R0001VTEo	K929903R	15X33W PROVENCE GRIEGE PLTH
K08296600001VTEo	K082966	2X33W PROVENCE GOLD PENCIL BRD
K08293300001VTEo	K082933	3X33W PROVENCE GOLD COVERING BRD
K08295500001VTEo	K082955	5X33W PROVENCE GOLD GEOMETRIC BRD
QUARZ		
K94543500001VTEo	K945435	45X45 QUARZ SAND MATT
K94543600001VTEo	K945436	45X45 QUARZ LGREY MATT
K94543700001VTEo	K945437	45X45 QUARZ GREY MATT
K94548400001VTEo	K945484	45X45 QUARZ MINK MATT
K94543500001VTEo	K945435	45X45 QUARZ SAND MATT
K94543600001VTEo	K945436	45X45 QUARZ LGREY MATT
K94543700001VTEo	K945437	45X45 QUARZ GREY MATT
K94548400001VTEo	K945484	45X45 QUARZ MINK MATT
K94542300001VTEo	K945423	25X40W QUARZ SAND MATT
K94542400001VTEo	K945424	25X40W QUARZ LGREY MATT
K94542500001VTEo	K945425	25X40W QUARZ GREY MATT
K94542600001VTEo	K945426	25X40W QUARZ WAVE DEC SAND MATT
K94542700001VTEo	K945427	25X40W QUARZ WAVE DEC LGREY MATT
K94542800001VTEo	K945428	25X40W QUARZ WAVE DEC GREY MATT
K94548000001VTEo	K945480	25X40W QUARZ MINK MATT
K94548100001VTEo	K945481	25X40W QUARZ WAVE DEC MINK MATT
STATUA		
K946269R0001VTSO	K946269R	33X100W STATUA WHITE GLS REC
K946270R0001VTSO	K946270R	33X100W STATUA LINE DEC WHITE GLS REC
K946271R0001VTSO	K946271R	33X100W STATUA WAVE DEC WHITE GLS REC
K946272FLPR1VTEo	K946272FLPR	60X60 STATUA WHITE FLPR 7REC
K946272LPR01VTEo	K946272LPR	60X60 STATUA WHITE LPR 7REC
STIX		
K94498700001VTEo	K944987	30X60W STIX WHITE MATT
K94498800001VTEo	K944988	30X60W STIX BLACK MATT
K94498900001VTEo	K944989	30X60W STIX WHITE LINE DEC MATT
K94499000001VTEo	K944990	30X60W STIX BLACK LINE DEC MATT
K94499100001VTEo	K944991	30X60W STIX WHITE H.LINE DEC MATT
K94499200001VTEo	K944992	30X60W STIX BLACK H.LINE DEC MATT
K94499400001VTEo	K944994	30X60W STIX WHITE PLATIN DEC MATT
K94499500001VTEo	K944995	30X60W STIX BLACK PLATIN DEC MATT
K94499300001VTEo	K944993	30X60W STIX BLACK SCORED MIX DEC MATT
STUDIO-MIX		
K946250R0001VTSO	K946250R	33X100W STUDIO CEMENT BLUSH MAT REC Studio-Mix
K946260R0001VTEo	K9462607R	60X60 STUDIO CEMENT BLUSH MATT R9 7REC Studio-Mix
K946249R0001VTSO	K946249R	33X100W STUDIO MARBLE PINK MATT REC Studio-Mix
K946641R0001VTSO	K946641R	33X100W STUDIO NUDE MATT REC Studio-Mix
STUDIO-PLATE		
K946248R0001VTSO	K946248R	33X100W STUDIO BRONZE MATT REC Studio-Plate

Yeni Ürün Kodu / New Product Code	Eski Ürün Kodu / Previous Product Code	Açıklama / Description
K946250R0001VTSO	K946250R	33X100W STUDIO CEMENT BLUSH MAT REC Studio-Plate
K946400R0001VTSO	K946400R	33X100W STUDIO-PLATE DEC BRONZE MATT 13M Studio-Plate
K946642R0001VTSO	K946642R	3X100W STUDIO-PLATE DEC CMNTB MATT 13MM Studio-Plate
STUDIO-TEX		
K946641R0001VTSO	K946641R	33X100W STUDIO NUDE MATT REC Studio-Tex
K946667R0001VTSO	K946667R	M33X100W STUDIO WHITE MATT REC Studio-Tex
K946251R0001VTSO	K946251R	33X100W STUDIO-TEX DEC NUDE MATT REC Studio-Tex
K946252R0001VTSO	K946252R	33X100W STUDIO-TEX DEC WHITE MATT REC Studio-Tex
STUDIO-TAB		
K946641R0001VTSO	K946641R	33X100W STUDIO NUDE MATT REC Studio-Tab
K946667R0001VTSO	K946667R	M33X100W STUDIO WHITE MATT REC Studio-Tab
K946254R0001VTSO	K946254R	33X100W STUDIO-TAB DEC NUDE MATT 13MM Studio-Tab
K946255R0001VTSO	K946255R	33X100W STUDIO-TAB DEC WHITE MATT 13MM Studio-Tab
TEXTONE		
K94545200001VTEO	K945452	45X45 TEXTONE BEIGE MATT
K94545300001VTEO	K945453	45X45 TEXTONE CREAM MATT
K94545400001VTEO	K945454	45X45 TEXTONE GREY MATT
K94545500001VTEO	K945455	45X45 TEXTONE LGREY MATT
K94544000001VTEO	K945440	25X40W TEXTONE BEIGE MATT
K94544100001VTEO	K945441	25X40W TEXTONE CREAM MATT
K94544200001VTEO	K945442	25X40W TEXTONE GREY MATT
K94544300001VTEO	K945443	25X40W TEXTONE LGREY MATT
TUNDRA SKY		
K945016LPR01VTEO	K945016LPR	M60X60 TUNDRA SKY GREY LPR 7REC
K945016LPR01VTEO	K945016LPR	M60X60 TUNDRA SKY GREY LPR
K944969R0001VTEO	K944969R	25X70W TUNDRA SKY GREY MAT REC
K944970R0001VTEO	K944970R	25X70W TUNDRA SKY CEMENT WHITE MAT REC
K944973R0001VTEO	K944973R	25X70W TUNDRA SKY GREY 3D DEC MAT REC
K944968R0001VTEO	K944968R	25X70W TUNDRA SKY GREY GLS REC
K944971R0001VTEO	K944971R	25X70W TUNDRA SKY PLAIN WHITE GLS REC
VERSUS M		
K94526400001VTEO	K945264	M45X45 VERSUS WHITE
K94526500001VTEO	K945265	M45X45 VERSUS ANTHRACITE
K94124300001VTEO	K941243	M30X60W VERSUS WHITE GLSY
K94125400001VTEO	K941254	M30X60W VERSUS GREY GLSY
K94128000001VTEO	K941280	M30X60W VERSUS WAVE DEC WHITE GLSY
K94129100001VTEO	K941291	M30X60W VERSUS WAVE DEC GREY GLSY
K94316900001VTEO	K943169	M30X60W VERSUS PLINTH WHITE GLSY
K94317100001VTEO	K943171	M30X60W VERSUS PLINTH GREY GLSY
K941243R0001VTEO	K941243R	M30X60W VERSUS WHITE GLSY REC
K941254R0001VTEO	K941254R	M30X60W VERSUS GREY GLSY REC
K941280R0001VTEO	K941280R	30X60W VERSUS WAVE DEC WHITE GLSY REC
K941291R0001VTEO	K941291R	M30X60W VERSUS WAVE DEC GREY GLSY REC
VERSUS S		
K94539300001VTEO	K945393	75X25W VERSUS CREAM BULL GLS

Ürün Kodları / Product Codes

Yeni Ürün Kodu / New Product Code	Eski Ürün Kodu / Previous Product Code	Açıklama / Description
K94539400001VTEo	K945394	75X25W VERSUS WARM GREY BULL GLS
K94539700001VTEo	K945397	45X45 VERSUS CREAM MATT
K94539800001VTEo	K945398	45X45 VERSUS WARM GREY MATT
K94517100001VTEo	K945171	25X40W VERSUS CREAM GLS
K94517200001VTEo	K945172	25X40W VERSUS WARM GREY GLS
K94517300001VTEo	K945173	25X40W VERSUS LWAVE DEC CREAM GLS
K94539200001VTEo	K945392	25X40W VERSUS LWAVE DEC WARM GREY GLS
VERSUS XL		
K943302LPR01VTEo	K943302LPR	M60X60 VERSUS ANTHRACITE LPR 7REC
K939342FLPR1VTEo	K939342FLPR	M60X60 VERSUS ANTHRACITE FLPR
K938351FLPR1VTEo	K938351FLPR	M60X60 VERSUS WHITE FLPR
K943302LPR01VTEo	K943302LPR	M60X60 VERSUS ANTHRACITE LPR
K944103LPR01VTEo	K944103LPR	M60X60 VERSUS WHITE LPR
K939353HR001VTEo	K939353HR	M80X80 VERSUS ANTHRACITE HONED TOUCH REC
K938432HR001VTEo	K938432HR	M80X80 VERSUS WHITE HONED TOUCH REC
K938432R0001VTEo	K938432R	M80X80 VERSUS WHITE R9 REC
K939353R0001VTEo	K939353R	M80X80 VERSUS ANTHRACITE R9 REC
K943034R0001VTEo	K943034R	M80X80 VERSUS WHITE RIGATO DEC REC
K943040R0001VTEo	K943040R	M80X80 VERSUS ANTRACITE RIGATO DEC REC
K937824R0001VTSO	K937824R	M33X100W VERSUS WHITE GLSY REC
K938966R0001VTSO	K938966R	M33X100W VERSUS PLINTH WHITE GLSY
K939320R0001VTSO	K939320R	M33X100W VERSUS GREY GLSY REC
K939331R0001VTSO	K939331R	M33X100W VERSUS PLINTH GREY GLSY
K941221R0001VTSO	K941221R	M33X100W VERSUS WAVE DEC WHITE GLSY
K941221R0001VTSO	K941232R	M33X100W VERSUS WAVE DEC GREY GLSY
K08597600001VTEo	K085976	M3X100W METAL STRIP BRD COPPER GLSY
K08601300001VTEo	K086013	M3X100W METAL STRIP BRD SILVER GLSY
DÜZ RENKLER		
K94775100001VTEo	K230110000	M20X20W RELIEF WHITE GLOSSY
K94775200001VTEo	K240040000	M20X25W WHITE GLOSSY
K94775000001VTEo	K240120001	M20X25W WHITE MATT
K77032400001VTEo	K770324	M20X30W WHITE GLOSSY
K77094300001VTEo	K770943	M20X30W RELIEF WHITE GLOSSY
K77710300001VTEo	K777103	M20X30W SATEN WHITE
K86914400001VTEo	K869144	M20X50W WHITE MATT
K87021600001VTEo	K870216	M20X50W WHITE GLOSSY
K92843300001VTEo	K928433	M20X60W WHITE MATT
K92842200001VTEo	K928422	M20X60W WHITE GLSY
K81629500001VTEo	K816295	M25X40W WHITE GLOSSY
K82241200001VTEo	K822412	M25X40W SATEN WHITE
K86739400001VTEo	K867394	M25X40W BLACK GLOSSY
K912554R0001VTEo	K912554R	M25X70W WHITE MATT REC
K82305300001VTEo	K823053	M30X60W WHITE GLOSSY N.REC
K82304200001VTEo	K823042	M30X60W SATIN WHITE N.REC

Yeni Ürün Kodu / New Product Code	Eski Ürün Kodu / Previous Product Code	Açıklama / Description
ARARAT		
K822751LPR01VTE0	K822751LPR	M30X60 ARARAT K.GRI LPR 9MM
K830962R0001VTE0	K830962R	M8.5x60 ARARAT K.GRI SUP MAT REC 9MM
K842350R0001VTE0	K842350R	M8.5x60 ARARAT GRI SUP MAT REC
K830936R0001VTE0	K830936R	M8.5x60 ARARAT FILDISI SUP MAT REC 9MM
K886623LPR01VTE0	K886623LPR	M60X60 ARARAT K.GRI LPR 9MM
K82275100001VTE0	K822751	M30X60 ARARAT K.GRI MAT 9MM
K822751R0001VTE0	K822751R	M30X60 ARARAT K.GRI MAT REC 9MM
K823156LPR01VTE0	K823156LPR	M30X60 ARARAT FILDISI LPR 9MM
K82315600001VTE0	K823156	M30X60 ARARAT FILDISI MAT 9MM
K823156R0001VTE0	K823156R	M30X60 ARARAT FILDISI MAT REC 9MM
K823171LPR01VTE0	K823171LPR	M30X60 ARARAT GRI LPR 9MM
K82317100001VTE0	K823171	M30X60 ARARAT GRI MAT 9MM
K823171R0001VTE0	K823171R	M30X60 ARARAT GRI MAT REC 9MM
K886590LPR01VTE0	K886590LPR	M60X60 ARARAT FILDISI LPR 9MM
K886590R0001VTE0	K886590R	M60X60 ARARAT FILDISI MAT REC 9MM
K886612LPR01VTE0	K886612LPR	M60X60 ARARAT GRI LPR 9MM
K886612R0001VTE0	K886612R	M60X60 ARARAT GRI MAT REC 9MM
K886623R0001VTE0	K886623R	M60X60 ARARAT K.GRI MAT REC 9MM
ASH AND BURN		
K9463638R001VTE0	K9463638R	M5X5 ASHANDBURN ACI KAHVE KSM R10B 7REK
K9463628R001VTE0	K9463628R	M5X5 ASHANDBURN KEMIK KSM R10B 7REK
K945677R0001VTE0	K945677R	M30X60 ASHANDBURN ACI KAHVE R9 7REK
K945678R0001VTE0	K945678R	M30X60 ASHANDBURN KEMIK R9 7REK
K945683R0001VTE0	K945683R	M60X60 ASHANDBURN ACI KAHVE R9 7REK
K945688R0001VTE0	K945688R	M8.5X60 ASHANDBURN ACIKAHVE SUP R9 7REK
K945684R0001VTE0	K945684R	M60X60 ASHANDBURN KEMIK R9 7REK
K945687R0001VTE0	K945687R	M8.5X60 ASHANDBURN KEMIK SUP R9 7REK
K945680R0001VTE0	K945680R	M40X80 ASHANDBURN KEMIK R9 7REK
K945689R0001VTE0	K945689R	M80X80 ASHANDBURN KEMIK R9 7REK
K945676R0001VTE0	K945676R	M10X80 ASHANDBURN KEMIK SUP R9 7REK
K946053R0001VTE0	K946053R	M10X80 ASHANDBURN KEMIK R9 7REK
K945679R0001VTE0	K945679R	M40X80 ASHANDBURN ACI KAHVE R9 7REK
K945690R0001VTE0	K945690R	M80X80 ASHANDBURN ACI KAHVE R9 7REK
K945675R0001VTE0	K945675R	M10X80 ASHANDBURN ACIKAHVE SUP R9 7REK
K946054R0001VTE0	K946054R	M10X80 ASHANDBURN ACI KAHVE R9 7REK
K94607200001VTE0	K946072	M7.5X30 ASHANDBURN KEMIK MAT
K94607300001VTE0	K946073	M21X24 ASHANDBURN ALTIGEN KEMIK MAT
K94607400001VTE0	K946074	M15X15 ASHANDBURN KEMIK MAT
K94607500001VTE0	K946075	M7.5X30 ASHANDBURN ACI KAHVE MAT
K94607600001VTE0	K946076	M21X24 ASHANDBURN ALTIGEN ACI KAHVE MAT
K94607700001VTE0	K946077	M15X15 ASHANDBURN ACI KAHVE MAT
K94607800001VTE0	K946078	M15X15 ASHANDBURN KEMIK MAT DEK
K94607900001VTE0	K946079	M15X15 ASHANDBURN ACI KAHVE MAT DEK
ASPENWOOD		
K94624100001VTE0	K946241	M20X120 ASPENWOOD KOYU GREJ R10A
K946241R0001VTE0	K946241R	M20X120 ASPENWOOD KOYU GREJ R10A 7REK
K94624200001VTE0	K946242	M20X120 ASPENWOOD BEJ R10A

Ürün Kodları / Product Codes

Yeni Ürün Kodu / New Product Code	Eski Ürün Kodu / Previous Product Code	Açıklama / Description
K946242R0001VTEO	K946242R	M20X120 ASPENWOOD BEJ R10A 7REK
K94624300001VTEO	K946243	M20X120 ASPENWOOD KIZIL R10A
K946243R0001VTEO	K946243R	M20X120 ASPENWOOD KIZIL R10A 7REK
K94624400001VTEO	K946244	M20X120 ASPENWOOD KOYU WENGE R10A
K946244R0001VTEO	K946244R	M20X120 ASPENWOOD KOYU WENGE R10A 7REK
K94569100001VTEO	K945691	M20X120 ASPENWOOD KOYU GRI R10A
K945691R0001VTEO	K945691R	M20X120 ASPENWOOD KOYU GRI R10A 7REK
K94569200001VTEO	K945692	M20X120 ASPENWOOD GREJ R10A
K945692R0001VTEO	K945692R	M20X120 ASPENWOOD GREJ R10A 7REK
K94569300001VTEO	K945693	M20X120 ASPENWOOD GRI R10A
K945693R0001VTEO	K945693R	M20X120 ASPENWOOD GRI R10A 7REK
K94569400001VTEO	K945694	M20X120 ASPENWOOD ANTRASIT R10A
K945694R0001VTEO	K945694R	M20X120 ASPENWOOD ANTRASIT R10A 7REK
K94569500001VTEO	K945695	M20X120 ASPENWOOD VENGE R10A
K945695R0001VTEO	K945695R	M20X120 ASPENWOOD VENGE R10A 7REK
K94569600001VTEO	K945696	M20X120 ASPENWOOD VIZON R10A
K945696R0001VTEO	K945696R	M20X120 ASPENWOOD VIZON R10A 7REK
BRICX		
K94608000001VTEO	K946080	M7.5X30 BRICX BEYAZ
K94608100001VTEO	K946081	M7.5X30 BRICX BEJ
K94608200001VTEO	K946082	M7.5X30 BRICX TABA
K94608300001VTEO	K946083	M7.5X30 BRICX GRI
BRITISH STONE		
K937264LPR01VTEO	K937264LPR	M60X60 BRITISH STONE ANTRASIT LPR
K937264R0001VTEO	K937264R	M60X60 BRITISH STONE ANTRASIT R10A REC
K934313LPR01VTEO	K934313LPR	M8.5X60 BRITISH STONE ANTRASIT SUP LPR
K934313R0001VTEO	K934313R	M8.5X60 BRITISH STONE ANTRASIT SUP REC
K937441LPR01VTEO	K937441LPR	M30X60 BRITISH STONE GRI LPR
K937441R0001VTEO	K937441R	M30X60 BRITISH STONE GRI REC R10 A
K937452LPR01VTEO	K937452LPR	M30X60 BRITISH STONE ANTRASIT LPR
K937452R0001VTEO	K937452R	M30X60 BRITISH STONE ANTRASIT REC R10 A
K937463LPR01VTEO	K937463LPR	M60X60 BRITISH STONE GRI LPR
K937463R0001VTEO	K937463R	M60X60 BRITISH STONE GRI R10A REC
K934302R0001VTEO	K934302R	M8.5X60 BRITISH STONE GRI SUP REC
K934302LPR01VTEO	K934302LPR	M8.5X60 BRITISH STONE GRI SUP LPR
K937474LPR01VTEO	K937474LPR	M60X60 BRITISH STONE BEJ LPR
K937474R0001VTEO	K937474R	M60X60 BRITISH STONE BEJ R10A REC
K942945LPR01VTEO	K942945LPR	M8.5X60 BRITISH STONE BEJ SUP LPR
K934291R0001VTEO	K934291R	M8.5X60 BRITISH STONE BEJ SUP REC
K937430LPR01VTEO	K937430LPR	M30X60 BRITISH STONE BEJ LPR
K937430R0001VTEO	K937430R	M30X60 BRITISH STONE BEJ REC R10 A
K944433LPR01VTEO	K944433LPR	60X60 BRITISH STONE BEYAZ LPR
K944433R0001VTEO	K944433R	M60X60 BRITISH STONE BEYAZ R10A REC
K944694R0001VTEO	K944694R	M8.5X60 BRITISH STONE BEYAZ SUP REC
K944696LPR01VTEO	K944696LPR	M8.5X60 BRITISH STONE BEYAZ SUP LPR
K944427LPR01VTEO	K944427LPR	M30X60 BRITISH STONE BEYAZ LPR
K944427R0001VTEO	K944427R	M30X60 BRITISH STONE BEYAZ REC R10 A
K0849528LPR1VTEO	K084952LPR	M5x5 BRITISH STONE ANTRASIT KSM BRD LPR
K0849528R001VTEO	K084952R	M5x5 BRITISH STONE ANTRASIT KSM BRD REC

Yeni Ürün Kodu / New Product Code	Eski Ürün Kodu / Previous Product Code	Açıklama / Description
K0849418LPR1VTE0	K084941LPR	M5x5 BRITISH STONE GRI KSM BRD LPR
K0849418R001VTE0	K084941R	M5x5 BRITISH STONE GRI KSM BRD REC
K0849308LPR1VTE0	K084930LPR	M5x5 BRITISH STONE BEJ KSM BRD LPR
K0849308R001VTE0	K084930R	M5x5 BRITISH STONE BEJ KSM BRD REC
K0862208LPR1VTE0	K086220LPR	M5x5 BRITISH STONE BEYAZ KSM BRD LPR
K0862218R001VTE0	K086221R	M5x5 BRITISH STONE BEYAZ KSM BRD REC
K932891LPR01VTE0	K932891LPR	M60X120 BRITISH STONE BEJ 7LPR
K932891R0001VTE0	K932891R	M60X120 BRITISH STONE BEJ R10A 7R
K932902LPR01VTE0	K932902LPR	M60X120 BRITISH STONE GRI 7LPR
K932902R0001VTE0	K932902R	M60X120 BRITISH STONE GRI R10A 7R
K932913LPR01VTE0	K932913LPR	M60X120 BRITISH STONE ANTRASIT 7LPR
K932913R0001VTE0	K932913R	M60X120 BRITISH STONE ANTRASIT R10A 7R
K932924LPR01VTE0	K932924LPR	M20X120 BRITISH STONE BEJ 7LPR
K932924R0001VTE0	K932924R	M20X120 BRITISH STONE BEJ R10A 7R
K932935LPR01VTE0	K932935LPR	M20X120 BRITISH STONE GRI 7LPR
K932935R0001VTE0	K932935R	M20X120 BRITISH STONE GRI R10A 7R
K932946LPR01VTE0	K932946LPR	M20X120 BRITISH STONE ANTRASIT 7LPR
K932946R0001VTE0	K932946R	M20X120 BRITISH STONE ANTRASIT R10A 7R
K937253LPR01VTE0	K937253LPR	M45X90 BRITISH STONE BEJ 7LPR
K943750LPR01VTE0	K943750LPR	M45X90 BRITISH STONE GRI 7LPR
K944426LPR01VTE0	K944426LPR	M20X120 BRITISH STONE BEYAZ 7LPR
K944426R0001VTE0	K944426R	M20X120 BRITISH STONE BEYAZ R10A 7R
K944431LPR01VTE0	K944431LPR	M60X120 BRITISH STONE BEYAZ 7LPR
K944431R0001VTE0	K944431R	M60X120 BRITISH STONE BEYAZ R10A 7R
K944571LPR01VTE0	K944571LPR	M45X90 BRITISH STONE BEYAZ 7LPR
K944693LPR01VTE0	K944693LPR	M45X90 BRITISH STONE ANTRASIT 7LPR
CALACATTA		
K943345HR001VTE0	K943345HR	M40X80 CALACATTA BEYAZ HONED TOUCH REC
K942999R0001VTE0	K942999R	M40X80 CALACATTA BEYAZ R9 REC
K942998HR001VTE0	K942998HR	M80X80 CALACATTA BEYAZ HONED TOUCH REC
K942998R0001VTE0	K942998R	M80X80 CALACATTA BEYAZ R9 REC
K943010R0001VTE0	K943010R	M80X80 CALACATTA RIGATO DEK REC
K943958FLPR1VTE0	K943958FLPR	M60X60 CALACATTA BEYAZ FLPR
K943959HR001VTE0	K943959HR	M60X60 CALACATTA BEYAZ HONED TOUCH REK
K943006FLPR1VTE0	K943006FLPR	M60X120 CALACATTA BEYAZ 7FLPR
K943007FLPR1VTE0	K943007FLPR	M20X120 CALACATTA BEYAZ 7FLPR
K946532FLPR1VTE0	K946532FLPR	M60X120 CALACATTA EKSTRA BEYAZ 7FLPR
K946533HR001VTE0	K946533HR	M60X120 CALACATTA EKSTRA BEYAZ HT 7R
COLORLINE		
K02908180001VTE0	K0290818	M25X25 COLORLINE MIX 1 YESIL-MAVI (NF)
K02947580001VTE0	K0294758	M25X25 COLORLINE MIX 4 SARI-MAVI (NF)
K02948680001VTE0	K0294868	M25X25 COLORLINE MIX 5 HAVUZ-MAVI (NF)
K51149380001VTE0	K5114938	M25X25 COLORLINE MIX 6 GRI (NF)
K51291680001VTE0	K5129168	M25X25 COLORLINE MIX 8 K.MAVI-YEŞİL (NF)
K51049040001VTE0	K5104904	M5X5 COLORLINE MIX 4 SARI-MAVI (KF)
K51150480001VTE0	K5115048	M5X5 COLORLINE MIX 6 GRI (NF)
K51292080001VTE0	K5129208	M5X5 COLORLINE MIX 8 K.MAVI-YESİL (NF)
K50898280001VTE0	K5089828	M5X5 COLORLINE MIX 1 YESIL-MAVI (NF)
K51050180001VTE0	K5105018	M5X5 COLORLINE MIX 5 HAVUZ MAVI (NF)

Ürün Kodları / Product Codes

Yeni Ürün Kodu / New Product Code	Eski Ürün Kodu / Previous Product Code	Açıklama / Description
CEMENT-TECH		
K943094LPR01VTEO	K943094LPR	M40X80 CEMENT-TECH BEYAZ LPR
K943094R0001VTEO	K943094R	M40X80 CEMENT-TECH BEYAZ R9 REC
K943095LPR01VTEO	K943095LPR	M40X80 CEMENT-TECH GRI LPR
K943095R0001VTEO	K943095R	M40X80 CEMENT-TECH GRI R9 REC
K943097LPR01VTEO	K943097LPR	M40X80 CEMENT-TECH ANTRASIT LPR
K943097R0001VTEO	K943097R	M40X80 CEMENT-TECH ANTRASIT R9 REC
K943091LPR01VTEO	K943091LPR	M80X80 CEMENT-TECH BEYAZ LPR
K943091R0001VTEO	K943091R	M80X80 CEMENT-TECH BEYAZ R9 REC
K943092LPR01VTEO	K943092LPR	M80X80 CEMENT-TECH GRI LPR
K943092R0001VTEO	K943092R	M80X80 CEMENT-TECH GRI R9 REC
K943093LPR01VTEO	K943093LPR	M80X80 CEMENT-TECH ANTRASIT LPR
K943093R0001VTEO	K943093R	M80X80 CEMENT-TECH ANTRASIT R9 REC
K943474R0001VTEO	K943474R	M60X60 CEMENT-TECH BEYAZ R9 REC
K943475R0001VTEO	K943475R	M60X60 CEMENT-TECH GRI R9 REC
K943476R0001VTEO	K943476R	M60X60 CEMENT-TECH ANTRASIT R9 REC
CITYRUG		
K94642100001VTEO	K946421	M21X24 CITYRUG HEXAGON TAŞ BEYAZ MAT
K94642200001VTEO	K946422	M21X24 CITYRUG HEXAGON SICAK DEK MAT
K94642300001VTEO	K946423	M21X24 CITYRUG HEXAGON SOGUK DEK MAT
CLAY-CEMENT		
K946226R0001VTEO	K946226R	M30X60 CLAY-CEMENT AGRI R9 7REK
K946227R0001VTEO	K946227R	M60X60 CLAY-CEMENT AGRI R9 7REK
K946228R0001VTEO	K946228R	M8.5X60 CLAY-CEMENT AGRI SUP R9 7REK
K945717R0001VTEO	K945717R	M60X60 CLAY-CEMENT FILDISI R9 7REK
K945725R0001VTEO	K945725R	M8.5X60 CLAY-CEMENT FILDISI SUP R9 7REK
K945706R0001VTEO	K945706R	M30X60 CLAY-CEMENT FILDISI R9 7REK
K945718R0001VTEO	K945718R	M60X60 CLAY-CEMENT TAUPE R9 7REK
K945726R0001VTEO	K945726R	M8.5X60 CLAY-CEMENT TAUPE SUP R9 7REK
K945707R0001VTEO	K945707R	M30X60 CLAY-CEMENT TAUPE R9 7REK
K945719R0001VTEO	K945719R	M60X60 CLAY-CEMENT GRI R9 7REK
K945727R0001VTEO	K945727R	M8.5X60 CLAY-CEMENT GRI SUP R9 7REK
K945705R0001VTEO	K945705R	M30X60 CLAY-CEMENT GRI R9 7REK
K945720R0001VTEO	K945720R	M60X60 CLAY-CEMENT TOPRAK R9 7REK
K945728R0001VTEO	K945728R	M8.5X60 CLAY-CEMENT TOPRAK SUP R9 7REK
K945708R0001VTEO	K945708R	M30X60 CLAY-CEMENT TOPRAK R9 7REK
K9463508R001VTEO	K946350R	M5X5 CLAY-CEMENT FILDISI KSM R10B 7REK
K9463738R001VTEO	K946373R	M30X60 CLAY-CEMENT FILDISI CBK R9 7REK
K9463788R001VTEO	K946378R	M30X60 CLAY-CEMENT FILDISI TUGLA R9 7REK
K9463518R001VTEO	K946351R	M5X5 CLAY-CEMENT TAUPE KSM R10B 7REK
K9463748R001VTEO	K946374R	M30X60 CLAY-CEMENT TAUPE CBK R9 7REK
K9463798R001VTEO	K946379R	M30X60 CLAY-CEMENT TAUPE TUGLA R9 7REK
K9463498R001VTEO	K946349R	M5X5 CLAY-CEMENT GRI KSM R10B 7REK
K9463728R001VTEO	K946372R	M30X60 CLAY-CEMENT GRI CBK R9 7REK
K9463778R001VTEO	K946377R	M30X60 CLAY-CEMENT GRI TUGLA R9 7REK
K9463528R001VTEO	K946352R	M5X5 CLAY-CEMENT TOPRAK KSM R10B 7REK
K9463758R001VTEO	K946375R	M30X60 CLAY-CEMENT TOPRAK CBK R9 7REK
K9463808R001VTEO	K946380R	M30X60 CLAY-CEMENT TOPRAK TUGLA R9 7REK
K9463488R001VTEO	K946348R	M5X5 CLAY-CEMENT AGRI KSM R10B 7REK

Yeni Ürün Kodu / New Product Code	Eski Ürün Kodu / Previous Product Code	Açıklama / Description
K9463718R001VTE0	K946371R	M30X60 CLAY-CEMENT AGRI CBK R9 7REK
K9463768R001VTE0	K946376R	M30X60 CLAY-CEMENT AGRI TUGLA R9 7REK
DAY-TO-DAY		
K54005480001VTE0	K5400548	M30x30 DAY-TO-DAY BEYAZ MIX PRL (NF)
K54008080001VTE0	K5400808	M30x30 DAY-TO-DAY AQUA MAVI MIX PRL (NF)
ESSENCE		
K944463R0001VTE0	K944463R	60X60 ESSENCE KREM ROLYEF R12C REC
K945863R0001VTE0	K945863R	30X30 ESSENCE KREM ROLYEF R12C REC
K944451R0001VTE0	K944451R	30X60 ESSENCE KREM ROLYEF R12C REC
K945233PR001VTE0	K945233P	60X60 ESSENCE KREM PARLAK REC
K944464R0001VTE0	K944464R	60X60 ESSENCE KREM R10 REC
K945230PR001VTE0	K945230P	30X60 ESSENCE KREM PARLAK REC
K944452R0001VTE0	K944452R	30X60 ESSENCE KREM R10 REC
K944469R0001VTE0	K944469R	60X60 ESSENCE AGRI ROLYEF R12C REC
K945864R0001VTE0	K945864R	30X30 ESSENCE AGRI ROLYEF R12C REC
K944457R0001VTE0	K944457R	30X60 ESSENCE AGRI ROLYEF R12C REC
K945231PR001VTE0	K945231P	60X60 ESSENCE ACIK GRI PARLAK
K944470R0001VTE0	K944470R	60X60 ESSENCE AGRI R10 REC
K945228PR001VTE0	K945228P	30X60 ESSENCE ACIK GRI PARLAK REC
K944458R0001VTE0	K944458R	30X60 ESSENCE AGRI R10 REC
K944472R0001VTE0	K944472R	60X60 ESSENCE K.GRI ROLYEF R12C REC
K945865R0001VTE0	K945865R	30X30 ESSENCE K.GRI ROLYEF R12C REC
K944460R0001VTE0	K944460R	30X60 ESSENCE K.GRI ROLYEF R12C REC
K945232PR001VTE0	K945232P	60X60 ESSENCE KOYU GRI PARLAK REC
K944473R0001VTE0	K944473R	60X60 ESSENCE K.GRI R10 REC
K945229PR001VTE0	K945229P	30X60 ESSENCE KOYU GRI PARLAK REC
K944461R0001VTE0	K944461R	30X60 ESSENCE K.GRI R10 REC
K945849PR001VTE0	K945849P	60X60 ESSENCE ANTRASIT PARLAK REC
K945853R0001VTE0	K945853R	60X60 ESSENCE ANTRASIT R10 REC
K945848PR001VTE0	K945848P	30X60 ESSENCE ANTRASIT PARLAK REC
K945852R0001VTE0	K945852R	30X60 ESSENCE ANTRASIT R10 REC
K945161PR001VTE0	K945161P	60X60 ESSENCE PARLAK MOKA REC
K945854R0001VTE0	K945854R	60X60 ESSENCE MOKA R10 REC
K945164PR001VTE0	K945164P	30X60 ESSENCE PARLAK MOKA REC
K945851R0001VTE0	K945851R	30X60 ESSENCE MOKA R10 REC
K945162PR001VTE0	K945162P	60X60 ESSENCE PARLAK BEYAZ REC
K945855R0001VTE0	K945855R	60X60 ESSENCE BEYAZ R10 REC
K945163PR001VTE0	K945163P	30X60 ESSENCE PARLAK BEYAZ REC
K945850R0001VTE0	K945850R	30X60 ESSENCE BEYAZ R10 REC
K945859R0001VTE0	K945859R	60X60 ESSENCE BEYAZ ROLYEF R12C REC
K945866R0001VTE0	K945866R	30X30 ESSENCE BEYAZ ROLYEF R12C REC
K945856R0001VTE0	K945856R	30X60 ESSENCE BEYAZ ROLYEF R12C REC
K945860R0001VTE0	K945860R	60X60 ESSENCE MOKA ROLYEF R12C REC
K945867R0001VTE0	K945867R	30X30 ESSENCE MOKA ROLYEF R12C REC
K945857R0001VTE0	K945857R	30X60 ESSENCE MOKA ROLYEF R12C REC
K945861R0001VTE0	K945861R	60X60 ESSENCE ANTRASIT ROLYEF R12C REC
K945868R0001VTE0	K945868R	30X30 ESSENCE ANTRASIT ROLYEF R12C REC
K945858R0001VTE0	K945858R	30X60 ESSENCE ANTRASIT ROLYEF R12C REC
K9459998R001VTE0	K945999R	5X5 ESSENCE KREM KSM BRD R12C REK

Ürün Kodları / Product Codes

Yeni Ürün Kodu / New Product Code	Eski Ürün Kodu / Previous Product Code	Açıklama / Description
K9460078R001VTEO	K946007R	5X5 ESSENCE KREM KSM BRD R10 REK
K9460008R001VTEO	K946000R	5X5 ESSENCE AGRİ KSM BRD R12C REK
K9460088R001VTEO	K946008R	5X5 ESSENCE AGRİ KSM BRD R10 REK
K9460038R001VTEO	K946003R	5X5 ESSENCE K.GRI KSM BRD R12C REK
K9460098R001VTEO	K946009R	5X5 ESSENCE K.GRI KSM BRD R10 REK
K9460108R001VTEO	K946010R	5X5 ESSENCE ANTRASİT KSM BRD R10 REK
K9460118R001VTEO	K946011R	5X5 ESSENCE MOKA KSM BRD R10 REK
K9460068R001VTEO	K946006R	5X5 ESSENCE BEYAZ KSM BRD R10 REK
K9459988R001VTEO	K945998R	5X5 ESSENCE BEYAZ KSM BRD R12C REK
K9460058R001VTEO	K946005R	5X5 ESSENCE MOKA KSM BRD R12C REK
K9460048R001VTEO	K946004R	5X5 ESSENCE ANTRASİT KSM BRD R12C REK
ICE AND SMOKE		
K946312R0001VTEO	K9463127R	M30X60 ICEANDSMOKE DUMAN GRI R9 7REK
K937651R0001VTEO	K9376517R	M60X60 ICEANDSMOKE BUZ GRI R9 7REK
K946313R0001VTEO	K9463137R	M30X60 ICEANDSMOKE BUZ GRI R9 7REK
K937065R0001VTEO	K937065R	M40X80 ICEANDSMOKE DUMAN GRI R9 REK
K937043R0001VTEO	K937043R	M80X80 ICEANDSMOKE DUMAN GRI R9 REK
K937485R0001VTEO	K937485R	M10X80 ICEANDSMOKE DUMAN GRI R9 REK
K937076R0001VTEO	K937076R	M40X80 ICEANDSMOKE BUZ GRI R9 REK
K937054R0001VTEO	K937054R	M80X80 ICEANDSMOKE BUZ GRI R9 REK
K937496R0001VTEO	K937496R	M10X80 ICEANDSMOKE BUZ GRI R9 REK
K943520R0001VTEO	K943520R	M10X80 ICEANDSMOKE DUMAN SUP MAT REK R9
K937124R0001VTEO	K937124R	M40X80 ICEANDSMOKE GEO MIX DEC R9 REK
K937640R0001VTEO	K937640R	M60X60 ICEANDSMOKE DUMAN GRI R9 REK
K943516R0001VTEO	K943516R	M10X80 ICEANDSMOKE BUZ SUP MAT REK R9
K94698300001VTEO	K946983	M15X15 ICEANDSMOKE ACI DUMAN GRI MAT
K94698400001VTEO	K946984	M21X24 ICEANDSMOKE ALTIGEN DUMAN GRI MAT
K94698500001VTEO	K946985	M7.5X30 ICEANDSMOKE DUMAN GRI MAT
K94698600001VTEO	K946986	M15X15 ICEANDSMOKE ACI BUZ GRI MAT
K94698700001VTEO	K946987	M21X24 ICEANDSMOKE ALTIGEN BUZ GRI MAT
K94698800001VTEO	K946988	M7.5X30 ICEANDSMOKE ACI BUZ GRI MAT
K94698900001VTEO	K946989	M15X15 ICEANDSMOKE ACI DUMAN GRI MAT DEK
K94699000001VTEO	K946990	M15X15 ICEANDSMOKE ACI BUZ GRI MAT DEK
ICE AND SMOKE PARLAK		
K935606FLPR1VTEO	K935606FLPR	M60X60 ICEANDSMOKE BUZ GRI FLPR
K935621FLPR1VTEO	K935621FLPR	M60X60 ICEANDSMOKE DUMAN GRI FLPR
K945153FLPR1VTEO	K945153FLPR	M8.5X60 ICEANDSMOKE BUZ GRI SUP FLPR
K945152FLPR1VTEO	K945152FLPR	M8.5X60 ICEANDSMOKE DUMAN GRI SUP FLPR
LOMBARDY		
K94627900001VTEO	K946279	M30X60 LOMBARDY ANTRASİT MAT R10B
K946279R0001VTEO	K946279R	M30X60 LOMBARDY ANTRASİT R10B REK
K94628000001VTEO	K946280	M30X60 LOMBARDY GRI MAT R10B
K946280R0001VTEO	K946280R	M30X60 LOMBARDY GRI R10B REK
K94628100001VTEO	K946281	M30X60 LOMBARDY KREM MAT R10B
K946281R0001VTEO	K946281R	M30X60 LOMBARDY KREM R10B REK
K94628200001VTEO	K946282	M30X60 LOMBARDY GREI MAT R10B
K946282R0001VTEO	K946282R	M30X60 LOMBARDY GREI R10B REK
K946283R0001VTEO	K946283R	M60X60 LOMBARDY ANTRASİT R10B REK
K946284R0001VTEO	K946284R	M60X60 LOMBARDY GRI R10B REK

Yeni Ürün Kodu / New Product Code	Eski Ürün Kodu / Previous Product Code	Açıklama / Description
K946285R0001VTEO	K946285R	M60X60 LOMBARDY KREM R10B REK
K946286R0001VTEO	K946286R	M60X60 LOMBARDY GREJ R10B REK
K94629640001VTEO	K9462964	5X5 LOMBARDY ANTRASIT R10B (KF)
K94629740001VTEO	K9462974	5X5 LOMBARDY GRI R10B (KF)
K94629840001VTEO	K9462984	5X5 LOMBARDY GREJ R10B (KF)
K94629940001VTEO	K9462994	5X5 LOMBARDY KREM R10B (KF)
K945309LPR01VTEO	K945309LPR	M30X60 LOMBARDY KREM LPR
K94530900001VTEO	K945309	M30X60 LOMBARDY KREM R9 NON REC
K945309R0001VTEO	K945309R	M30X60 LOMBARDY KREM R9 REC
K945310LPR01VTEO	K945310LPR	M60X60 LOMBARDY KREM LPR
K945310R0001VTEO	K945310R	M60X60 LOMBARDY KREM R9 REC
K94531100001VTEO	K945311	M45X45 LOMBARDY KREM R9 NON REC
K945312LPR01VTEO	K945312LPR	M30X60 LOMBARDY ANTRASIT LPR
K94531200001VTEO	K945312	M30X60 LOMBARDY ANTRASIT R9 NON REC
K945312R0001VTEO	K945312R	M30X60 LOMBARDY ANTRASIT R9 REC
K945313LPR01VTEO	K945313LPR	M60X60 LOMBARDY ANTRASIT LPR
K945313R0001VTEO	K945313R	M60X60 LOMBARDY ANTRASIT R9 REC
K94531400001VTEO	K945314	M45X45 LOMBARDY ANTRASIT R9 NON REC
K945315LPR01VTEO	K945315LPR	M30X60 LOMBARDY GRI LPR
K94531500001VTEO	K945315	M30X60 LOMBARDY GRI R9 NON REC
K945315R0001VTEO	K945315R	M30X60 LOMBARDY GRI R9 REC
K945316LPR01VTEO	K945316LPR	M60X60 LOMBARDY GRI LPR
K945316R0001VTEO	K945316R	M60X60 LOMBARDY GRI R9 REC
K94531700001VTEO	K945317	M45X45 LOMBARDY GRI R9 NON REC
K945318LPR01VTEO	K945318LPR	M30X60 LOMBARDY GREJ LPR
K94531800001VTEO	K945318	M30X60 LOMBARDY GREJ R9 NON REC
K945318R0001VTEO	K945318R	M30X60 LOMBARDY GREJ R9 REC
K945319LPR01VTEO	K945319LPR	M60X60 LOMBARDY GREJ LPR
K945319R0001VTEO	K945319R	M60X60 LOMBARDY GREJ R9 REC
K94532000001VTEO	K945320	M45X45 LOMBARDY GREJ R9 NON REC
K945534R0001VTEO	K945534R	M60X120 LOMBARDY GREJ R9 7R
K945535R0001VTEO	K945535R	M60X120 LOMBARDY GRI R9 7R
K945536R0001VTEO	K945536R	M60X120 LOMBARDY ANTRASIT R9 7R
K945539R0001VTEO	K945539R	M60X120 LOMBARDY KREM R9 7R
MARFIM		
K943174FLPR1VTEO	K943174FLPR	M60X120 MARFIM BEJ 7FLPR
K94372000001VTEO	K943720	M45X45 MARFIM GRI MAT
K943965FLPR1VTEO	K943965FLPR	M60X60 MARFIM BEJ 2FLPR
K943988FLPR1VTEO	K943988FLPR	M60X60 MARFIM GRI 2FLPR
MARMORI		
K947000FLPR1VTEO	K947000FLPR	60X60 MARMORI CALACATTA BEYAZ 7FLPR
K947001FLPR1VTEO	K947001FLPR	60X60 MARMORI PULPIS BRONZ 7FLPR
K947002FLPR1VTEO	K947002FLPR	60X60 MARMORI ROYAL FILDISI 7FLPR
K947003FLPR1VTEO	K947003FLPR	60X60 MARMORI FIOR GREJ 7FLPR
K947004FLPR1VTEO	K947004FLPR	30X60 MARMORI ROYAL FILDISI 7FLPR
K947005FLPR1VTEO	K947005FLPR	60X120 MARMORI PULPIS FILDISI 7FLPR
K947006FLPR1VTEO	K947006FLPR	60X60 MARMORI ST.LAURENT SIYAH 7FLPR
K947007FLPR1VTEO	K947007FLPR	60X60 MARMORI CLOUD GRI 7FLPR
K947008FLPR1VTEO	K947008FLPR	30X60 MARMORI PULPIS FILDISI 7FLPR

Ürün Kodları / Product Codes

Yeni Ürün Kodu / New Product Code	Eski Ürün Kodu / Previous Product Code	Açıklama / Description
K947009FLPR1VTEO	K947009FLPR	30X60 MARMORI CARRARA BEYAZ 7FLPR
K947010FLPR1VTEO	K947010FLPR	30X60 MARMORI CLOUD GRI 7FLPR
K947011FLPR1VTEO	K947011FLPR	60X120 MARMORI ST. LAURENT SIYAH 7FLPR
K947012FLPR1VTEO	K947012FLPR	30X60 MARMORI ST. LAURENT SIYAH 7FLPR
K947013FLPR1VTEO	K947013FLPR	60X120 MARMORI PULPIS BRONZ 7FLPR
K947014FLPR1VTEO	K947014FLPR	60X60 MARMORI PULPIS FILDISI 7FLPR
K947015FLPR1VTEO	K947015FLPR	60X60 MARMORI CARRARA BEYAZ 7FLPR
K947016FLPR1VTEO	K947016FLPR	30X60 MARMORI FIOR GREJ 7FLPR
K947017FLPR1VTEO	K947017FLPR	60X120 MARMORI ROYAL FILDİŞİ 7FLPR
K947018FLPR1VTEO	K947018FLPR	60X120 MARMORI FIOR GREJ 7FLPR
K947019FLPR1VTEO	K947019FLPR	60X120 MARMORI CLOUD GRI 7FLPR
K947020FLPR1VTEO	K947020FLPR	30X60 MARMORI CALACATTA BEYAZ 7FLPR
K947021FLPR1VTEO	K947021FLPR	60X120 MARMORI CALACATTA BEYAZ 7FLPR
K947022FLPR1VTEO	K947022FLPR	30X60 MARMORI PULPIS BRONZ 7FLPR
K947023FLPR1VTEO	K947023FLPR	60X120 MARMORI CARRARA BEYAZ 7FLPR
MERIDIEN		
K94444500001VTEO	K944445	M30x60 MERIDIEN ANTRASIT R10A
K94444600001VTEO	K944446	M30x60 MERIDIEN KREM R10A
K94444700001VTEO	K944447	M30x60 MERIDIEN GRI R10A
K944448LPR01VTEO	K944448LPR	M60x60 MERIDIEN ANTRASIT LPR
K94444800001VTEO	K944448	M60x60 MERIDIEN ANTRASIT R10A
K9463014R001VTEO	K9463014R	5X5 MERIDIEN ANTRASIT KESME MOZAIK R10B
K944449LPR01VTEO	K944449LPR	M60x60 MERIDIEN KREM LPR
K94444900001VTEO	K944449	M60x60 MERIDIEN KREM R10A
K9463024R001VTEO	K9463024R	5X5 MERIDIEN KREM KESME MOZAIK R10B (KF)
K944450LPR01VTEO	K944450LPR	M60x60 MERIDIEN GRI LPR
K94445000001VTEO	K944450	M60x60 MERIDIEN GRI R10A
K9463004R001VTEO	K9463004R	5X5 MERIDIEN GRI KESME MOZAIK R10B (KF)
K94628740001VTEO	K9462874	5X5 MERIDIEN GRI R10B (KF)
K94628840001VTEO	K9462884	5X5 MERIDIEN ANTRASIT R10B (KF)
K94628940001VTEO	K9462894	5X5 MERIDIEN KREM R10B (KF)
K944445R0001VTEO	K944445R	M30x60 MERIDIEN ANTRASIT R10A REC
K944446R0001VTEO	K944446R	M30x60 MERIDIEN KREM R10A REC
K944447R0001VTEO	K944447R	M30x60 MERIDIEN GRI R10A REC
K944448R0001VTEO	K944448R	M60x60 MERIDIEN ANTRASIT R10A REC
K944449R0001VTEO	K944449R	M60x60 MERIDIEN KREM R10A REC
K944450R0001VTEO	K944450R	M60x60 MERIDIEN GRI R10A REC
METRO		
K54168500001VTEO	K541685	M30X30 METRO BAZALT MAT R10A
K54168700001VTEO	K541687	M30X30 METRO AKAHVE MAT R10A
K54168900001VTEO	K541689	M30X30 METRO KAHVE MAT R10A
K54169100001VTEO	K541691	M30X30 METRO GRI MAT R10A
K943304LPR01VTEO	K943304LPR	M30X60 METRO GRI LPR
K943304R0001VTEO	K943304R	M30X60 METRO GRI MAT R10A REC
K943305LPR01VTEO	K943305LPR	M60X60 METRO GRI LPR
K943305R0001VTEO	K943305R	M60X60 METRO GRI MAT R10A REC
K943307LPR01VTEO	K943307LPR	M60X60 METRO BAZALT LPR
K943307R0001VTEO	K943307R	M60X60 METRO BAZALT MAT R10A REC
K943896R0001VTEO	K943896R	8,5X60 METRO GRI SUP MAT REC

Yeni Ürün Kodu / New Product Code	Eski Ürün Kodu / Previous Product Code	Açıklama / Description
K943308LPR01VTE0	K943308LPR	M60X60 METRO ANTRASIT LPR
K943308R0001VTE0	K943308R	M60X60 METRO ANTRASIT MAT R10A REC
K943897R0001VTE0	K943897R	8,5X60 METRO BAZALT SUP MAT REC
K943309LPR01VTE0	K943309LPR	M60X60 METRO BEJ LPR
K943309R0001VTE0	K943309R	M60X60 METRO BEJ MAT R10A REC
K943898R0001VTE0	K943898R	8,5X60 METRO ANTRASIT SUP MAT REC
K943311LPR01VTE0	K943311LPR	M60X60 METRO AKAHVE LPR
K943311R0001VTE0	K943311R	M60X60 METRO AKAHVE MAT R10A REC
K943312LPR01VTE0	K943312LPR	M60X60 METRO KAHVE LPR
K943899R0001VTE0	K943899R	8,5X60 METRO BEJ SUP MAT REC
K943312R0001VTE0	K943312R	M60X60 METRO KAHVE MAT R10A REC
K943900R0001VTE0	K943900R	8,5X60 METRO SCHLAMM SUP MAT REC
K943313LPR01VTE0	K943313LPR	M45X90 METRO GRI LAPPATO REC
K943313R0001VTE0	K943313R	M45X90 METRO GRI MAT R10A REC
K943314LPR01VTE0	K943314LPR	M45X90 METRO BAZALT LAPPATO REC
K943901R0001VTE0	K943901R	8,5X60 METRO KAHVE SUP MAT REC
K943314R0001VTE0	K943314R	M45X90 METRO BAZALT MAT R10A REC
K943315LPR01VTE0	K943315LPR	M45X90 METRO ANTRASIT LAPPATO REC
K943315R0001VTE0	K943315R	M45X90 METRO ANTRASIT MAT R10A REC
K943316LPR01VTE0	K943316LPR	M45X90 METRO BEJ LAPPATO REC
K943316R0001VTE0	K943316R	M45X90 METRO BEJ MAT R10A REC
K943317LPR01VTE0	K943317LPR	M45X90 METRO AKAHVE LPR
K943317R0001VTE0	K943317R	M45X90 METRO AKAHVE MAT R10A REC
K943318LPR01VTE0	K943318LPR	M45X90 METRO KAHVE LAPPATO REC
K943318R0001VTE0	K943318R	M45X90 METRO KAHVE MAT R10A REC
K943324LPR01VTE0	K943324LPR	M30X60 METRO ANTRASIT LPR
K943324R0001VTE0	K943324R	M30X60 METRO ANTRASIT MAT R10A REC
K943325LPR01VTE0	K943325LPR	M30X60 METRO BAZALT LPR
K943325R0001VTE0	K943325R	M30X60 METRO BAZALT MAT R10A REC
K943326LPR01VTE0	K943326LPR	M30X60 METRO BEJ LPR
K943326R0001VTE0	K943326R	M30X60 METRO BEJ MAT R10A REC
K943327LPR01VTE0	K943327LPR	M30X60 METRO AKAHVE LPR
K943327R0001VTE0	K943327R	M30X60 METRO AKAHVE MAT R10A REC
K943328LPR01VTE0	K943328LPR	M30X60 METRO KAHVE LPR
K943328R0001VTE0	K943328R	M30X60 METRO KAHVE MAT R10A REC
K94376700001VTE0	K943767	M30X30 METRO ANTRASIT MAT R10A
K94376800001VTE0	K943768	M30X30 METRO BEJ MAT R10A
K94435800001VTE0	K944358	M45x45 METRO ANTHRACITE MATT
K94435900001VTE0	K944359	M45x45 METRO BAZALT MATT
K94436000001VTE0	K944360	M45x45 METRO BEIGE MATT
K94436100001VTE0	K944361	M45x45 METRO AKAHVE MATT
K94436200001VTE0	K944362	M45x45 METRO D.BROWN MATT
K94436300001VTE0	K944363	M45x45 METRO GREY MATT
K944406LPR01VTE0	K944406LPR	M30X60 METRO ACIK GRI LPR
K944406R0001VTE0	K944406R	M30X60 METRO ACIK GRI R10A REC
K944414LPR01VTE0	K944414LPR	M60X60 METRO AGRI LPR
K944414R0001VTE0	K944414R	M60X60 METRO AGRI R10A REC
K94456900001VTE0	K944569	M45X45 METRO LGREY MATT
K94468800001VTE0	K944688	M30X30 METRO AGRI MAT R10A

Ürün Kodları / Product Codes

Yeni Ürün Kodu / New Product Code	Eski Ürün Kodu / Previous Product Code	Açıklama / Description
K945119R0001VTE0	K945119R	8,5X60 METRO AGRI SUP MAT REC
K944689LPR01VTE0	K944689LPR	M45X90 METRO AGRI LAPPATO REC
K944689R0001VTE0	K944689R	M45X90 METRO AGRI MAT R10A REC
K945123R0001VTE0	K945123R	M30x60D METRO KREM MAT REC
K945124R0001VTE0	K945124R	M30x60D METRO GRI MAT REC
K945145R0001VTE0	K945145R	M30x60D METRO BEYAZ MAT REC
K5416944R001VTE0	K5416944R	M5X5 METRO MIX 2 MOZAIK KALT REC(KF)R10B
K5416934R001VTE0	K5416934R	M5X5 METRO MIX 1 KSM MOZAIK REC(KF) R10B
K9463948R001VTE0	K946394R	15X15 METRO KESME BORDUR GRI
K9463938R001VTE0	K946393R	15X15 METRO KESME BORDUR BASALT
K9463928R001VTE0	K946392R	15X15 METRO KESME BORDUR ANTRASIT
K9463958R001VTE0	K946395R	15X15 METRO KESME BORDUR BEJ
K0862258LPR1VTE0	K086225LPR	M5X5 METRO GRI LPR R9
K0861748R001VTE0	K086174R	M5X5 METRO GRI KSM MOZAIK REC R10B
K0862288LPR1VTE0	K086228LPR	M5X5 METRO BAZALT LPR R9
K0861788R001VTE0	K086178R	M5X5 METRO BASALT KSM MOZAIK REC R10B
K0862298LPR1VTE0	K086229LPR	M5X5 METRO ANTRASIT LPR R9
K0861738R001VTE0	K086173R	M5X5 METRO ANTRASIT KSM MOZAIK REC R10B
K0862278LPR1VTE0	K086227LPR	M5X5 METRO BEJ LPR R9
K0861758R001VTE0	K086175R	M5X5 METRO BEJ KSM MOZAIK REC R10B
K0862318LPR1VTE0	K086231LPR	M5X5 METRO KAHVE LPR R9
K0861778R001VTE0	K086177R	M5X5 METRO KAHVE KSM MOZAIK REC R10B
K0862308LPR1VTE0	K086230LPR	M5X5 METRO AKAHVE LPR R9
K0861768R001VTE0	K086176R	M5X5 METRO AKAHVE KSM MOZAIK REC R10B
K0862268LPR1VTE0	K086226LPR	M5X5 METRO AGRI LPR R9
K0862248R001VTE0	K086224R	M5X5 METRO AGRI KSM MOZAIK REC R10B
METRO TILES		
K94528380001VTE0	K9452838	M10X10 MINIWORX RAL 0001500 METRO PRL (NF)
K94530500001VTE0	K945305	M10X20 MINIWORX RAL 0001500 METRO PRL
K94529100001VTE0	K945291	M10X30 MINIWORX RAL 0001500 METRO PRL
K94528800001VTE0	K945288	M20X20 MINIWORX RAL 0001500 METRO PRL
K94528280001VTE0	K9452828	M10X10 MINIWORX RAL 9016 METRO PRL (NF)
K94530400001VTE0	K945304	M10X20 MINIWORX RAL 9016 METRO PRL
K94529000001VTE0	K945290	M10X30 MINIWORX RAL 9016 METRO PRL
K94528700001VTE0	K945287	M20X20 MINIWORX RAL 9016 METRO PRL
K94528480001VTE0	K9452848	M10X10 MINIWORX RAL 0958010 METRO PRL (NF)
K94528500001VTE0	K945285	M10X20 MINIWORX RAL 0958010 METRO PRL
K94529200001VTE0	K945292	M10X30 MINIWORX RAL 0958010 METRO PRL
K94528900001VTE0	K945289	M20X20 MINIWORX RAL 0958010 METRO PRL
K94759780001VTE0		M10X10 MINIWORX RAL 0005500 METRO PRL (NF)
K94759800001VTE0		M10X20 MINIWORX RAL 0005500 METRO PRL
K94760000001VTE0		M10X30 MINIWORX RAL 0005500 METRO PRL
K94759900001VTE0		M20X20 MINIWORX RAL 0005500 METRO PRL
K94528600001VTE0	K945286	M10X20 MINIWORX ALTIN METRO PRL
K94551300001VTE0	K945513	M20X20 MINIWORX ALTIN METRO PRL
K52356080001VTE0	K5235608	M2,5X5 METRO TILES BEYAZ PARLAK (NF)
K52357180001VTE0	K5235718	M2,5X5 METRO TILES SIYAH PARLAK (NF)
K53509580001VTE0	K5350958	M2,5X5 METRO TILES KREM PARLAK (NF)
K52358280001VTE0	K5235828	M5X10 METRO TILES BEYAZ PARLAK (NF)
K52359380001VTE0	K5235938	M5X10 METRO TILES SIYAH PARLAK (NF)
K53247280001VTE0	K5324728	M5X10 METRO TILES KREM PARLAK (NF)

Yeni Ürün Kodu / New Product Code	Eski Ürün Kodu / Previous Product Code	Açıklama / Description
MICROTEC		
K86478200001VTE0	K864782	M60X60 MICROTEC ANTRASIT PRL
K864480R0001VTE0	K864480R	M60X60 MICROTEC ANTRASIT MAT REC
K86473400001VTE0	K864734	M30X60 MICROTEC ANTRASIT PRL
K864454R0001VTE0	K864454R	M30X60 MICROTEC ANTRASIT MAT REC
K86479300001VTE0	K864793	M60X60 MICROTEC GRI PRL
K864491R0001VTE0	K864491R	M60X60 MICROTEC GRI MAT REC
K86474500001VTE0	K864745	M30X60 MICROTEC GRI PRL
K864465R0001VTE0	K864465R	M30X60 MICROTEC GRI MAT REC
K86481500001VTE0	K864815	M60X60 MICROTEC BEYAZ PRL
K864771R0001VTE0	K864771R	M60X60 MICROTEC BEYAZ MAT REC
K86476000001VTE0	K864760	M30X60 MICROTEC BEYAZ PRL
K864723R0001VTE0	K864723R	M30X60 MICROTEC BEYAZ MAT REC
K87353200001VTE0	K873532	M60X60 MICROTEC MOKA PRL
K873506R0001VTE0	K873506R	M60X60 MICROTEC MOKA MAT REC
K87347300001VTE0	K873473	M30X60 MICROTEC MOKA PRL
K873440R0001VTE0	K873440R	M30X60 MICROTEC MOKA MAT REC
K87374200001VTE0	K873742	M60X60 MICROTEC AKREM PRL
K873731R0001VTE0	K873731R	M60X60 MICROTEC AKREM MAT REC
K87372000001VTE0	K873720	M30X60 MICROTEC AKREM PRL
K873716R0001VTE0	K873716R	M30X60 MICROTEC AKREM MAT REC
K92626300001VTE0	K926263	M60X60 MICROTEC AGRI PRL
K926020R0001VTE0	K926020R	M60X60 MICROTEC AGRI MAT REC
K92603100001VTE0	K926031	M30X60 MICROTEC AGRI PRL
K926042R0001VTE0	K926042R	M30X60 MICROTEC AGRI MAT REC
K0815558R001VTE0	K081555R	M5x5 MICROTEC ANTRASIT KSM BRD MAT
K0815668R001VTE0	K081566R	M5x5 MICROTEC GRI KSM BRD MAT REC
K0815448R001VTE0	K081544R	M5x5 MICROTEC BEYAZ KSM BRD MAT REC
K0815818R001VTE0	K081581R	M5x5 MICROTEC MOKA KSM BRD MAT REC
K0815338R001VTE0	K081533R	M5x5 MICROTEC AKREM KSM BRD MAT REC
K0815708R001VTE0	K081570R	M5x5 MICROTEC AGRI KSM BRD MAT REC
NEWCON		
K945772LPR01VTE0	K945772LPR	M60X120 NEWCON K.GRI R9 7LPR
K945773LPR01VTE0	K945773LPR	M60X120 NEWCON BEYAZ R9 7LPR
K945774LPR01VTE0	K945774LPR	M60X120 NEWCON TAUPE R9 7LPR
K945775LPR01VTE0	K945775LPR	M60X120 NEWCON KREM R9 7LPR
K946184R0001VTE0	K946184R	M30X60 NEWCON ANTRASIT BSMK R10A 7REK
K946186R0001VTE0	K946186R	M30X60 NEWCON K.GRI BSMK R10A 7REK
K946187R0001VTE0	K946187R	M30X60 NEWCON S.GRI BSMK R10A 7REK
K946188R0001VTE0	K946188R	M30X60 NEWCON TAUPE BSMK R10A 7REK
K945776LPR01VTE0	K945776LPR	M60X120 NEWCON ANTRASIT R9 7LPR
K946502R0001VTE0	K946502R	M30X120 NEWCON K.GRI BSMK R10A 7REK
K945778LPR01VTE0	K945778LPR	M60X120 NEWCON S.GRI R9 7LPR
K946505R0001VTE0	K946505R	M30X120 NEWCON BEYAZ BSMK R10A 7REK
K946504R0001VTE0	K946504R	M30X120 NEWCON TAUPE BSMK R10A 7REK
K946501R0001VTE0	K946501R	M30X120 NEWCON KREM BSMK R10A 7REK
K946166R0001VTE0	K946166R	M30X60 NEWCON ANTRASIT MAT R11B 7REK
K946500R0001VTE0	K946500R	M30X120 NEWCON ANTRASIT BSMK R10A 7REK
K946503R0001VTE0	K946503R	M30X120 NEWCON S.GRI BSMK R10A 7REK

Ürün Kodları / Product Codes

Yeni Ürün Kodu / New Product Code	Eski Ürün Kodu / Previous Product Code	Açıklama / Description
K946167R0001VTE0	K946167R	M30X60 NEWCON KREM R11B 7REK
K946185R0001VTE0	K946185R	M30X60 NEWCON KREM BSMK R10A 7REK
K946168R0001VTE0	K946168R	M30X60 NEWCON K.GRI R11B 7REK
K946170R0001VTE0	K946170R	M30X60 NEWCON TAUPE R11B 7REK
K946169R0001VTE0	K946169R	M30X60 NEWCON S.GRI R11B 7REK
K946171R0001VTE0	K946171R	M30X60 NEWCON BEYAZ R11B 7REK
K946189R0001VTE0	K946189R	M30X60 NEWCON BEYAZ BSMK R10A 7REK
K946172LPR01VTE0	K946172LPR	M80X80 NEWCON ANTRASIT 7LPR
K946172R0001VTE0	K946172R	M80X80 NEWCON ANTRASIT R10A 7REK
K946173LPR01VTE0	K946173LPR	M80X80 NEWCON KREM 7LPR
K946173R0001VTE0	K946173R	M80X80 NEWCON KREM R10A 7REK
K946174LPR01VTE0	K946174LPR	M80X80 NEWCON K.GRI 7LPR
K946174R0001VTE0	K946174R	M80X80 NEWCON K.GRI R10A 7REK
K946178R0001VTE0	K946178R	M10X80 NEWCON ANTRASIT SUP R10A 7REK
K946175LPR01VTE0	K946175LPR	M80X80 NEWCON S.GRI 7LPR
K946175R0001VTE0	K946175R	M80X80 NEWCON S.GRI R10A 7REK
K946179R0001VTE0	K946179R	M10X80 NEWCON KREM SUP R10A 7REK
K946176LPR01VTE0	K946176LPR	M80X80 NEWCON TAUPE 7LPR
K946176R0001VTE0	K946176R	M80X80 NEWCON TAUPE R10A 7REK
K946180R0001VTE0	K946180R	M10X80 NEWCON K.GRI SUP R10A 7REK
K946177LPR01VTE0	K946177LPR	M80X80 NEWCON BEYAZ 7LPR
K946177R0001VTE0	K946177R	M80X80 NEWCON BEYAZ R10A 7REK
K946181R0001VTE0	K946181R	M10X80 NEWCON S.GRI SUP R10A 7REK
K94632980001VTE0	K9463298	5X5 NEWCON K.GRI R10B (NF)
K94633080001VTE0	K9463308	5X5 NEWCON BEYAZ R10B (NF)
K946182R0001VTE0	K946182R	M10X80 NEWCON TAUPE SUP R10A 7REK
K94633180001VTE0	K9463318	5X5 NEWCON S.GRI R10B (NF)
K94633280001VTE0	K9463328	5X5 NEWCON TAUPE R10B (NF)
K946183R0001VTE0	K946183R	M10X80 NEWCON BEYAZ SUP R10A 7REK
K94633380001VTE0	K9463338	5X5 NEWCON KREM R10B (NF)
K94633480001VTE0	K9463348	5X5 NEWCON ANTRASIT R10B (NF)
K94645200001VTE0	K946452	M30X30 NEWCON K.GRI R10A
K94645300001VTE0	K946453	M30X30 NEWCON TAUPE R10A
K94645400001VTE0	K946454	M30X30 NEWCON S.GRI R10A
K94645500001VTE0	K946455	M30X30 NEWCON ANTRASIT R10A
K94645600001VTE0	K946456	M30X30 NEWCON BEYAZ R10A
K94645700001VTE0	K946457	M30X30 NEWCON KREM R10A
K945745LPR01VTE0	K945745LPR	M30X60 NEWCON ANTRASIT R9 7LPR
K945745R0001VTE0	K945745R	M30X60 NEWCON ANTRASIT R10A 7REK
K945746LPR01VTE0	K945746LPR	M30X60 NEWCON KREM R9 7LPR
K945746R0001VTE0	K945746R	M30X60 NEWCON KREM R10A 7REK
K945751LPR01VTE0	K945751LPR	M30X60 NEWCON K.GRI R9 7LPR
K945751R0001VTE0	K945751R	M30X60 NEWCON K.GRI R10A 7REK
K945752LPR01VTE0	K945752LPR	M30X60 NEWCON S.GRI R9 7LPR
K945752R0001VTE0	K945752R	M30X60 NEWCON S.GRI R10A 7REK
K945753LPR01VTE0	K945753LPR	M30X60 NEWCON TAUPE R9 7LPR
K945753R0001VTE0	K945753R	M30X60 NEWCON TAUPE R10A 7REK
K945754LPR01VTE0	K945754LPR	M30X60 NEWCON BEYAZ R9 7LPR
K945754R0001VTE0	K945754R	M30X60 NEWCON BEYAZ R10A 7REK

Yeni Ürün Kodu / New Product Code	Eski Ürün Kodu / Previous Product Code	Açıklama / Description
K94576100001VTE0	K945761	M45X45 NEWCON K.GRI MAT
K94576200001VTE0	K945762	M45X45 NEWCON TAUPE MAT
K94576300001VTE0	K945763	M45X45 NEWCON S.GRI MAT
K94576400001VTE0	K945764	M45X45 NEWCON ANTRASIT MAT
K94579100001VTE0	K945791	M8.5X45 NEWCON K.GRI SUP
K94576500001VTE0	K945765	M45X45 NEWCON BEYAZ MAT
K94579200001VTE0	K945792	M8.5X45 NEWCON TAUPE SUP
K94576600001VTE0	K945766	M45X45 NEWCON KREM MAT
K94579300001VTE0	K945793	M8.5X45 NEWCON S.GRI SUP
K945772R0001VTE0	K945772R	M60X120 NEWCON K.GRI R10A 7REK
K94579400001VTE0	K945794	M8.5X45 NEWCON ANTRASIT SUP
K945773R0001VTE0	K945773R	M60X120 NEWCON BEYAZ R10A 7REK
K94579500001VTE0	K945795	M8.5X45 NEWCON BEYAZ SUP
K945774R0001VTE0	K945774R	M60X120 NEWCON TAUPE R10A 7REK
K94579600001VTE0	K945796	M8.5X45 NEWCON KREM SUP
K945775R0001VTE0	K945775R	M60X120 NEWCON KREM R10A 7REK
K945776R0001VTE0	K945776R	M60X120 NEWCON ANTRASIT R10A 7REK
K945778R0001VTE0	K945778R	M60X120 NEWCON S.GRI R10A 7REK
K945779LPR01VTE0	K945779LPR	M60X60 NEWCON ANTRASIT R9 7LPR
K945779R0001VTE0	K945779R	M60X60 NEWCON ANTRASIT R10A 7REK
K945743R0001VTE0	K945743R	8.5X60 NEWCON S.GRI SUP R10A
K945780R0001VTE0	K945780R	M60X60 NEWCON ANTRASIT R11B 7REK
K945781LPR01VTE0	K945781LPR	M60X60 NEWCON KREM R9 7LPR
K945741R0001VTE0	K945741R	8.5X60 NEWCON ANTRASIT SUP R10A
K945781R0001VTE0	K945781R	M60X60 NEWCON KREM R10A 7REK
K945782R0001VTE0	K945782R	M60X60 NEWCON KREM R11B 7REK
K945783LPR01VTE0	K945783LPR	M60X60 NEWCON K.GRI R9 7LPR
K945749R0001VTE0	K945749R	8.5X60 NEWCON KREM SUP R10A
K945783R0001VTE0	K945783R	M60X60 NEWCON K.GRI R10A 7REK
K945784LPR01VTE0	K945784LPR	M60X60 NEWCON TAUPE R9 7LPR
K945784R0001VTE0	K945784R	M60X60 NEWCON TAUPE R10A 7REK
K945742R0001VTE0	K945742R	8.5X60 NEWCON K.GRI SUP R10A
K945785LPR01VTE0	K945785LPR	M60X60 NEWCON S.GRI R9 7LPR
K945785R0001VTE0	K945785R	M60X60 NEWCON S.GRI R10A 7REK
K945744R0001VTE0	K945744R	8.5X60 NEWCON TAUPE SUP R10A
K945786LPR01VTE0	K945786LPR	M60X60 NEWCON BEYAZ R9 7LPR
K945786R0001VTE0	K945786R	M60X60 NEWCON BEYAZ R10A 7REK
K945787R0001VTE0	K945787R	M60X60 NEWCON K.GRI R11B 7REK
K945788R0001VTE0	K945788R	M60X60 NEWCON TAUPE R11B 7REK
K945750R0001VTE0	K945750R	8.5X60 NEWCON BEYAZ SUP R10A
K945789R0001VTE0	K945789R	M60X60 NEWCON S.GRI R11B 7REK
K945790R0001VTE0	K945790R	M60X60 NEWCON BEYAZ R11B 7REK
K9464618LPR1VTE0	K946461LPR	M30X60 NEWCON KOMBI MOZAIK ANTRASIT R9 L
K9464618R001VTE0	K946461R	M30X60 NEWCON KOMBI MOZAIK ANTRASIT R10B
K9464638LPR1VTE0	K946463LPR	M30X60 NEWCON KOMBI MOZAIK KREM R9 LPR
K9464638R001VTE0	K946463R	M30X60 NEWCON KOMBI MOZAIK KREM R10B
K9464588LPR1VTE0	K946458LPR	M30X60 NEWCON KOMBI MOZAIK K.GRI R9 LPR
K9464588R001VTE0	K946458R	M30X60 NEWCON KOMBI MOZAIK K.GRI R10B
K9464598LPR1VTE0	K946459LPR	M30X60 NEWCON KOMBI MOZAIK TAUPE R9 LPR

Ürün Kodları / Product Codes

Yeni Ürün Kodu / New Product Code	Eski Ürün Kodu / Previous Product Code	Açıklama / Description
K9464598R001VTE0	K946459R	M30X60 NEWCON KOMBI MOZAIK TAUPE R10B
K9464608LPR1VTE0	K946460LPR	M30X60 NEWCON KOMBI MOZAIK S.GRI R9 LPR
K9464608R001VTE0	K946460R	M30X60 NEWCON KOMBI MOZAIK S.GRI R10B
K9464628LPR1VTE0	K946462LPR	M30X60 NEWCON KOMBI MOZAIK BEYAZ R9 LPR
K9464628R001VTE0	K946462R	M30X60 NEWCON KOMBI MOZAIK BEYAZ R10B
K9457698LPR1VTE0	K945769LPR	M5X5 NEWCON S.GRI KSMMOZAIK R9 7LPR
K9457698R001VTE0	K945769R	M5X5 NEWCON S.GRI KSMMOZAIK R10B
K9457668LPR1VTE0	K945766LPR	M5X5 NEWCON ANTRASIT KSMMOZAIK R9 7LPR
K9457668R001VTE0	K945766R	M5X5 NEWCON ANTRASIT KSMMOZAIK R10B
K9457678R001VTE0	K945767R	M5X5 NEWCON KREM KSMMOZAIK R10B
K9457678LPR1VTE0	K945767LPR	M5X5 NEWCON KREM KSMMOZAIK R9 7LPR
K9457688LPR1VTE0	K945768LPR	M5X5 NEWCON K.GRI KSMMOZAIK R9 7LPR
K9457688R001VTE0	K945768R	M5X5 NEWCON K.GRI KSMMOZAIK R10B
K9457708LPR1VTE0	K945770LPR	M5X5 NEWCON TAUPE KSMMOZAIK R9 7LPR
K9457708R001VTE0	K945770R	M5X5 NEWCON TAUPE KSMMOZAIK R10B
K9457718LPR1VTE0	K945771LPR	M5X5 NEWCON BEYAZ KSMMOZAIK R9 7LPR
K9457718R001VTE0	K945771R	M5X5 NEWCON BEYAZ KSMMOZAIK R10B
NITRIUM		
K945187FLPR1VTE0	K945187FLPR	M60X60 NITRIUM GRI FLPR
K945188FLPR1VTE0	K945188FLPR	M60X60 NITRIUM BEYAZ FLPR
K945195FLPR1VTE0	K945195FLPR	M60X60 NITRIUM KREM FLPR
PERA		
K924211R0001VTE0	K924211R	M20X120 PERA BEYAZ R9 7REC
K924222R0001VTE0	K924222R	M20X120 PERA SIYAH R9 7REC
K924255R0001VTE0	K924255R	M20X120 PERA BEYAZ DEK 1 R9 7REC
K924270R0001VTE0	K924270R	M20X120 PERA SIYAH DEK 1 R9 7REC
K944491R0001VTE0	K944491R	M20X120 PERA GRI R9 7REC
K944492R0001VTE0	K944492R	20X120 PERA GRI DEK.1 R9 7REC
K944493R0001VTE0	K944493R	M20X120 PERA BEYAZ ESKITME DEK R9 7REC
K944494R0001VTE0	K944494R	20X120 PERA GRI ESKITME DEK R9 7REC
K944495R0001VTE0	K944495R	20X120 PERA SIYAH ESKITME DEK R9 7REC
PICCADILLY		
K922995R0001VTE0	K922995R	M60X60 PICCADILLY BEYAZ R9 REC
K923076R0001VTE0	K923076R	M30X60 PICCADILLY BEYAZ R9 REC
K923006R0001VTE0	K923006R	M60X60 PICCADILLY GRI R9 REC
K923021R0001VTE0	K923021R	M60X60 PICCADILLY GREJ R9 REC
K923080R0001VTE0	K923080R	M30X60 PICCADILLY GRI R9 REC
K923102R0001VTE0	K923102R	M30X60 PICCADILLY GREJ R9 REC
K0848938R001VTE0	K084893R	M5x5 PICCADILLY BEYAZ KSM BRD R10 B REC
K0849048R001VTE0	K084904R	M5x5 PICCADILLY GRI KSM BRD R10 B REC
K0849158R001VTE0	K084915R	M5x5 PICCADILLY GREJ KSM BRD R10 B REC
K922951LPR01VTE0	K922951LPR	M45X90 PICCADILLY BEYAZ 7LPR
K922951R0001VTE0	K922951R	M45X90 PICCADILLY BEYAZ R9 7R
K922962LPR01VTE0	K922962LPR	M45X90 PICCADILLY GRI 7LPR
K922962R0001VTE0	K922962R	M45X90 PICCADILLY GRI R9 7R
K922995LPR01VTE0	K922995LPR	M60X60 PICCADILLY BEYAZ 2LPR
K923006LPR01VTE0	K923006LPR	M60X60 PICCADILLY GRI 2LPR
K923113LPR01VTE0	K923113LPR	M45X90 PICCADILLY BEYAZ DEK 7LPR
K923113R0001VTE0	K923113R	45X90 PICCADILLY BEYAZ DEK 7R

Yeni Ürün Kodu / New Product Code	Eski Ürün Kodu / Previous Product Code	Açıklama / Description
K923124LPR01VTE0	K923124LPR	M45X90 PICCADILLY GRI DEK 7LPR
K923124R0001VTE0	K923124R	M45X90 PICCADILLY GRI DEK 7R
K925762LPR01VTE0	K925762LPR	M30X60 PICCADILLY BEYAZ 2LPR
K925773LPR01VTE0	K925773LPR	M30X60 PICCADILLY GRI 2LPR
K933241R0001VTE0	K933241R	8.5X45 PICCADILLY BEYAZ SUP 7R
K933252R0001VTE0	K933252R	8.5X45 PICCADILLY GRI SUP 7R
K933436R0001VTE0	K933436R	M8.5X60 PICCADILLY BEYAZ SUP R9 2R
K939703R0001VTE0	K939703R	M15X90 PICCADILLY GRI R9 7R
K939714R0001VTE0	K939714R	M15X90 PICCADILLY BEYAZ R9 7R
K943155R0001VTE0	K943155R	M8.5X60 PICCADILLY SUP. GRI R9A 2R
PIETRA PIENZA		
K909006R0001VTE0	K909006R	M60X60 PIETRA PIENZA BEJ R9 REC
K909010R0001VTE0	K909010R	M60X60 PIETRA PIENZA A.GRI R9 REC
K909021R0001VTE0	K909021R	M60X60 PIETRA PIENZA K.GRI R9 REC
K909032R0001VTE0	K909032R	M60X60 PIETRA PIENZA ANTRASIT R9 REC
K909043R0001VTE0	K909043R	M60X60 PIETRA PIENZA BEJ R10B REC
K909161R0001VTE0	K909161R	M8.5X60 PIETRA PIENZA BEJ SUP R9 REC
K909172R0001VTE0	K909172R	M8.5X60 PIETRA PIENZA A.GRI SUP R9 REC
K909054R0001VTE0	K909054R	M60X60 PIETRA PIENZA A.GRI R10B REC
K909194R0001VTE0	K909194R	M8.5X60 PIETRA PIENZA ANTRASIT SUP R9REC
K909065R0001VTE0	K909065R	M60X60 PIETRA PIENZA K.GRI R10B REC
K909076R0001VTE0	K909076R	M60X60 PIETRA PIENZA ANTRASIT R10B REC
K909080R0001VTE0	K909080R	M30X60 PIETRA PIENZA BEJ R9 REC
K909091R0001VTE0	K909091R	M30X60 PIETRA PIENZA A.GRI R9 REC
K909102R0001VTE0	K909102R	M30X60 PIETRA PIENZA K.GRI R9 REC
K909113R0001VTE0	K909113R	M30X60 PIETRA PIENZA ANTRASIT R9 REC
K909183R0001VTE0	K909183R	M8.5X60 PIETRA PIENZA K.GRI SUP R9 REC
K0758638R001VTE0	K075863R	M30X60 PIETRA PIENZA BEJ KSM DEK R10B
K0758748R001VTE0	K075874R	M30X60 PIETRA PIENZA A.GRI KSM DEK R10B
K0758858R001VTE0	K075885R	M30X60 PIETRA PIENZA K.GRI KSM DEK R10B
K0758968R001VTE0	K075896R	M30X60 PIETRA PIENZA ANTRT KSM DEK R10B
K0759008R001VTE0	K075900R	M15X30 PIETRA PIENZA BEJ KSM DEK R10B R
K0759818R001VTE0	K075981R	M3x3 PIETRA PIENZA BEJ KSM BRD R10B REC
K0759928R001VTE0	K075992R	M3x3 PIETRA PIENZA A.GRI KSM BRD R10B RE
K0759118R001VTE0	K075911R	M15X30 PIETRA PIENZA A.GRI KSM DEK R10B
K0759228R001VTE0	K075922R	M15X30 PIETRA PIENZA K.GRI KSM DEK R10B
K0760038R001VTE0	K076003R	M3x3 PIETRA PIENZA K.GRI KSM BRD R10B RE
K0759338R001VTE0	K075933R	M15X30 PIETRA PIENZA ANTRASIT KSM DEK R
K0760148R001VTE0	K076014R	M3x3 PIETRA PIENZA ANTRASIT KSM BRD R10B
K90908000001VTE0	K909080	M30X60 PIETRA PIENZA BEIGE R9
K913125R0001VTE0	K913125R	M45X90 PIETRA PIENZA BEJ R9 7R
K913136R0001VTE0	K913136R	M45X90 PIETRA PIENZA A.GRI R9 7R
K913140R0001VTE0	K913140R	M45X90 PIETRA PIENZA K.GRI R9 7R
K913151R0001VTE0	K913151R	M45X90 PIETRA PIENZA ANTRASIT R9 7R
PIETRA PIENZA S		
K92271500001VTE0	K922715	M45X45 PIETRA PIENZA BEJ 9MM
K92272600001VTE0	K922726	M45X45 PIETRA PIENZA A.GRI 9MM
K92273000001VTE0	K922730	M45X45 PIETRA PIENZA K.GRI 9MM
K92274100001VTE0	K922741	M45X45 PIETRA PIENZA ANTRASIT 9MM

Ürün Kodları / Product Codes

Yeni Ürün Kodu / New Product Code	Eski Ürün Kodu / Previous Product Code	Açıklama / Description
K94495100001VTE0	K944951	25X40D PIETRA PIENZA AGRI CZG DEK MAT
K94495200001VTE0	K944952	25X40D PIETRA PIENZA AGRI MAT
K94495400001VTE0	K944954	25X40D PIETRA PIENZA ANTRASIT CZG DEK MA
K94495500001VTE0	K944955	25X40D PIETRA PIENZA ANTRASIT MAT
K94495700001VTE0	K944957	25X40D PIETRA PIENZA BEJ CZG DEK MAT
K94495800001VTE0	K944958	25X40D PIETRA PIENZA BEJ MAT
K94496000001VTE0	K944960	25X40D PIETRA PIENZA K.GRI CZG DEK MAT
K94496100001VTE0	K944961	25X40D PIETRA PIENZA K.GRI MAT
QUARZITE		
K86442100001VTE0	K864421	M30X60 QUARZITE BEJ
K86443200001VTE0	K864432	M30X60 QUARZITE AGRI
K86681200001VTE0	K866812	M30X60 QUARZITE K.GRI
K86901500001VTE0	K869015	M30X60 QUARZITE ANTRASIT
K05974380001VTE0	K059743	M2.5X5 QUARZITE BEJ KESME BRD
K05975480001VTE0	K059754	M2.5X5 QUARZITE AGRI KESME BRD
K05976580001VTE0	K059765	M2.5X5 QUARZITE K.GRI KESME BRD
K05977680001VTE0	K059776	M2.5X5 QUARZITE ANTRASIT KESME BRD
RAINFOREST		
K914864R0001VTE0	K914864R	M60X60 RAINFOREST BEYAZ REC
K914304R0001VTE0	K914304R	M30X60 RAINFOREST BEYAZ REC
K914875R0001VTE0	K914875R	M60X60 RAINFOREST ANTRASIT REC
K914901R0001VTE0	K914901R	M8.5X60 RAINFOREST ANTRASIT SUP REC
K914890R0001VTE0	K914890R	M8.5X60 RAINFOREST BEYAZ SUP REC
K914886R0001VTE0	K914886R	M30X60 RAINFOREST ANTRASIT REC
K0765048R001VTE0	K076504R	M30X60 RAINFOREST BEYAZ KSM DEK REC
K0765158R001VTE0	K076515R	M30X60 RAINFOREST ANTRASIT KSM DEK REC
SAMBA		
K08100600001VTE0	K081006	M20X120 SAMBA BEJ DEC R10
K081006R0001VTE0	K081006R	M20X120 SAMBA BEJ DEC R10 7REC
K08101000001VTE0	K081010	M20X120 SAMBA WENGE DEC R10
K081010R0001VTE0	K081010R	M20X120 SAMBA WENGE DEC R10 7REC
K08102100001VTE0	K081021	M20X120 SAMBA A.OAK DEC R10
K081021R0001VTE0	K081021R	M20X120 SAMBA A.OAK DEC R10 7REC
K925353R0001VTE0	K925353R	M20X120 SAMBA BEJ R10 7REC
K925364R0001VTE0	K925364R	M20X120 SAMBA WENGE R10 7REC
K925375R0001VTE0	K925375R	M20X120 SAMBA A.OAK R10 7REC
K943058R0001VTE0	K943058R	M20X120 SAMBA MEŞE R10 7REC
K943059R0001VTE0	K943059R	M20X120 SAMBA AVENGE R10 7REC
K92535300001VTE0	K925353	M20X120 SAMBA BEJ R10
K92536400001VTE0	K925364	M20X120 SAMBA WENGE R10
K92537500001VTE0	K925375	M20X120 SAMBA A.OAK R10
K94305800001VTE0	K943058	M20X120 SAMBA MEŞE R10
K94305900001VTE0	K943059	M20X120 SAMBA AVENGE R10
SLATEMIX		
K94606600001VTE0	K946066	M7.5X30 SLATEMIX ANTRASIT
K94606700001VTE0	K946067	M7.5X30 SLATEMIX K.GRI
K94606800001VTE0	K946068	M7.5X30 SLATEMIX MULTICOLOR
K94606900001VTE0	K946069	M15X15 SLATEMIX ANTRASIT
K94607000001VTE0	K946070	M15X15 SLATEMIX K.GRI

Yeni Ürün Kodu / New Product Code	Eski Ürün Kodu / Previous Product Code	Açıklama / Description
K94607100001VTE0	K946071	M15X15 SLATEMIX MULTICOLOR
STONEWAY		
K94393800001VTE0	K943938	M45X45 STONEWAY KREM R9
K94393900001VTE0	K943939	M45X45 STONEWAY BEJ R9
K94394100001VTE0	K943941	M45X45 STONEWAY TABA R9
K94398300001VTE0	K943983	M45X45 STONEWAY KAHVE R9
K94398500001VTE0	K943985	M45X45 STONEWAY AGRİ R9
TECH-SLATE		
K944546R0001VTE0	K944546R	30X60 TECH-SLATE BEYAZ R10A REC
K944548R0001VTE0	K944548R	30X60 TECH-SLATE KOYU GRI R10A REC
K944549R0001VTE0	K944549R	30X60 TECH-SLATE ANTRASİT R10A REC
K944550R0001VTE0	K944550R	60X60 TECH-SLATE BEYAZ R10A REC
K944552R0001VTE0	K944552R	60X60 TECH-SLATE KOYU GRI R10A REC
K9459158R001VTE0	K9459158R	M5X5 TECH-SLATE KOYU GRI MAT R10B REC
K944553R0001VTE0	K944553R	60X60 TECH-SLATE ANTRASİT R10A REC
K944892R0001VTE0	K944892R	M60X60 TECH-SLATE ALTİGEN K.GRI R10A REC
K9459168R001VTE0	K9459168R	M5X5 TECH-SLATE BEYAZ MAT R10B REC
K944897R0001VTE0	K944897R	M60X60 TECH-SLATE ALTİGEN BEYAZ RİGATO R
K944898R0001VTE0	K944898R	M60X60 TECH-SLATE ALTİGEN K.GRI RİGATO R
K944899R0001VTE0	K944899R	M60X60 TECH-SLATE ALTİGEN ANTRASİT RİGAT
K944891R0001VTE0	K944891R	M60X60 TECH-SLATE ALTİGEN BEYAZ R10A REC
K9459148R001VTE0	K9459148R	M5X5 TECH-SLATE ANTRASİT MAT R10B REC
K944893R0001VTE0	K944893R	M60X60 TECH-SLATE ALTİGEN ANTRASİT R10A R
K9461938R001VTE0	K946193R	M30X60 TECH-SLATE ANTRASİT KESME DEK REK
K9459518R001VTE0	K945951R	M30X60 TECH-SLATE K.GRI KSM DEK REC
K9459508R001VTE0	K945950R	M30X60 TECH-SLATE BEYAZ KSM DEK REC
K944541R0001VTE0	K944541R	15X90 TECH-SLATE BEYAZ R10A 7R
K944543R0001VTE0	K944543R	15X90 TECH-SLATE KOYU GRI R10A 7R
K944545R0001VTE0	K944545R	15X90 TECH-SLATE ANTRASİT R10A 7R
K944554R0001VTE0	K944554R	45X90 TECH-SLATE BEYAZ R10A 7R
K944557R0001VTE0	K944557R	45X90 TECH-SLATE KOYU GRI R10A 7R
K944558R0001VTE0	K944558R	45X90 TECH-SLATE ANTRASİT R10A 7R
TRUVA		
K76176200001VTE0	K761762	33X33 TRUVA KREM.
K76177300001VTE0	K761773	33X33 TRUVA BEJ
K76178400001VTE0	K761784	33X33 TRUVA GRI
K76685000001VTE0	K766850	33X33 TRUVA BEYAZ
UPTOWN		
K916765LPR01VTE0	K916765LPR	M22.5X90 UPTOWN KREM LPR 10MM
K916765R0001VTE0	K916765R	M22.5X90 UPTOWN KREM MAT REC
K916776LPR01VTE0	K916776LPR	M22.5X90 UPTOWN VİZON LPR
K916776R0001VTE0	K916776R	M22.5X90 UPTOWN VİZON MAT REC
K916780LPR01VTE0	K916780LPR	M22.5X90 UPTOWN BEYAZ LPR 10MM
K916780R0001VTE0	K916780R	M22.5X90 UPTOWN BEYAZ MAT REC
K914120LPR01VTE0	K914120LPR	M60X60 UPTOWN KREM LPR
K914120R0001VTE0	K914120R	M60X60 UPTOWN KREM REC
K914153LPR01VTE0	K914153LPR	M30X60 UPTOWN KREM LPR
K914131LPR01VTE0	K914131LPR	M60X60 UPTOWN VİZON LPR

Ürün Kodları / Product Codes

Yeni Ürün Kodu / New Product Code	Eski Ürün Kodu / Previous Product Code	Açıklama / Description
K914131R0001VTE0	K914131R	M60X60 UPTOWN VIZON REC
K914142LPR01VTE0	K914142LPR	M60X60 UPTOWN BEYAZ LPR
K914142R0001VTE0	K914142R	M60X60 UPTOWN BEYAZ REC
K914175LPR01VTE0	K914175LPR	M30X60 UPTOWN BEYAZ LPR
K914153R0001VTE0	K914153R	M30X60 UPTOWN KREM REC
K914164LPR01VTE0	K914164LPR	M30X60 UPTOWN VIZON LPR
K914164R0001VTE0	K914164R	M30X60 UPTOWN VIZON REC
K914175R0001VTE0	K914175R	M30X60 UPTOWN BEYAZ REC
K916791LPR01VTE0	K916791LPR	M225X90 UPTOWN K.GRI LPR 10MM
K916791R0001VTE0	K916791R	M 225x90 UPTOWN K.GRI MAT REC
K914805LPR01VTE0	K914805LPR	M60X60 UPTOWN K.GRI LPR
K914805R0001VTE0	K914805R	M60X60 UPTOWN K.GRI MAT REC
K914816LPR01VTE0	K914816LPR	M30X60 UPTOWN K.GRI LPR
K914816R0001VTE0	K914816R	M30X60 UPTOWN K.GRI REC
K914094LPR01VTE0	K914094LPR	M45X90 UPTOWN KREM 7LPR
K914094R0001VTE0	K914094R	M45X90 UPTOWN KREM 7R
K914105LPR01VTE0	K914105LPR	M45X90 UPTOWN VIZON 7LPR
K914105R0001VTE0	K914105R	M45X90 UPTOWN VIZON 7R
K914116LPR01VTE0	K914116LPR	M45X90 UPTOWN BEYAZ 7LPR
K914116R0001VTE0	K914116R	M45X90 UPTOWN BEYAZ 7R
K914212LPR01VTE0	K914212LPR	M8.5X45 UPTOWN KREM SUP 7LPR
K914223LPR01VTE0	K914223LPR	M8.5X45 UPTOWN VIZON SUP 7LPR
K914234LPR01VTE0	K914234LPR	M8.5X45 UPTOWN BEYAZ SUP 7LPR
K914794LPR01VTE0	K914794LPR	M45X90 UPTOWN K.GRI 7LPR
K914794R0001VTE0	K914794R	M45X90 UPTOWN K.GRI MAT 7R
K914831LPR01VTE0	K914831LPR	M8.5X45 UPTOWN K.GRI SUP 7LPR
K916802LPR01VTE0	K916802LPR	M15X90 UPTOWN KREM 7LPR
K916802R0001VTE0	K916802R	M15X90 UPTOWN KREM MAT 7R
K916813LPR01VTE0	K916813LPR	M15X90 UPTOWN VIZON 7LPR
K916813R0001VTE0	K916813R	M15X90 UPTOWN VIZON MAT 7R
K916824LPR01VTE0	K916824LPR	M15X90 UPTOWN BEYAZ 7LPR
K916824R0001VTE0	K916824R	M15X90 UPTOWN BEYAZ MAT 7R
K916835LPR01VTE0	K916835LPR	M15X90 UPTOWN K.GRI 7LPR
K916835R0001VTE0	K916835R	M15X90 UPTOWN K.GRI MAT 7R
URBAN BLUE		
K945823R0001VTE0	K945823R	M40X80 URBANBLUE K.GRI R9 7REK
K945837R0001VTE0	K945837R	M80X80 URBANBLUE K.GRI R9 7REK
K946023R0001VTE0	K946023R	M10X80 URBANBLUE K.GRI ANTIK 7REK
K945824R0001VTE0	K945824R	M40X80 URBANBLUE ANTRASIT R9 7REK
K945839R0001VTE0	K945839R	M80X80 URBANBLUE ANTRASIT R9 7REK
K945817R0001VTE0	K945817R	M10X80 URBANBLUE K.GRI SUP R9 7REK
K946052R0001VTE0	K946052R	M10X80 URBANBLUE ANTRASIT ANTIK 7REK
K945841R0001VTE0	K945841R	M80X80 URBANBLUE K.GRI ANTIK 7REK
K945842R0001VTE0	K945842R	M80X80 URBANBLUE ANTRASIT ANTIK 7REK
K945818R0001VTE0	K945818R	M10X80 URBANBLUE ANTRASIT SUP R9 7REK
K9462228R001VTE0	K946222R	M30X60 URBAN BLUE MIX KESME DEK MAT REC
K9458298R001VTE0	K945829R	M5X5 URBANBLUE K.GRI KSM R10B 7REK
K9458308R001VTE0	K945830R	M5X5 URBANBLUE ANTRASIT KSM R10B 7REK
URBAN QUARZITE		

Yeni Ürün Kodu / New Product Code	Eski Ürün Kodu / Previous Product Code	Açıklama / Description
K946997R0001VTE0	K946997R	M60X60 URBAN QUARZITE KOYU BEJ R10A REK
K943469R0001VTE0	K943469R	M60X60 URBAN QUARZITE BEYAZ R10A REC
K943470R0001VTE0	K943470R	M60X60 URBAN QUARZITE BEJ R10A REC
K943471R0001VTE0	K943471R	M60X60 URBAN QUARZITE GRI R10A REC
K943473R0001VTE0	K943473R	M60X60 URBAN QUARZITE ANTRASIT R10A REC
K943359R0001VTE0	K943359R	M60X120 URBAN QUARZITE BEYAZ R10A 7R
K943360R0001VTE0	K943360R	M60X120 URBAN QUARZITE BEJ R10A 7R
K943361R0001VTE0	K943361R	M60X120 URBAN QUARZITE GRI R10A 7R
K943362R0001VTE0	K943362R	M60X120 URBAN QUARZITE ANTRASIT R10A 7R
K946681R0001VTE0	K946681R	M60X120 URBAN QUARZITE KOYU BEJ R10A7R
VADO		
K53945080001VTE0	K5394508	M5x5 VADO SOFT KAHVE (NF)
K53947280001VTE0	K5394728	M5x5 VADO MOKA (NF)
K53943580001VTE0	K5394358	M5x5 VADO GRI (NF)
K53944680001VTE0	K5394468	M5x5 VADO BEYAZ (NF)
K53946180001VTE0	K5394618	M5x5 VADO BEJ (NF)
K53948380001VTE0	K5394838	M5x5 VADO ANTRASIT (NF)
K90170200001VTE0	K901702	M8.5x60 VADO GRI SUP
K90172400001VTE0	K901724	M8.5x60 VADO MOKA SUP
K90173500001VTE0	K901735	M8.5x60 VADO SOFT KAHVE SUP
K90174600001VTE0	K901746	M8.5x60 VADO BEJ SUP
K90141100001VTE0	K901411	M30X60 VADO GRI
K901411R0001VTE0	K901411R	M30X60 VADO GRI REC
K90142200001VTE0	K901422	M30X60 VADO BEJ
K901422R0001VTE0	K901422R	M30X60 VADO BEJ REC
K90147000001VTE0	K901470	M30X60 VADO ANTRASIT
K901470R0001VTE0	K901470R	M30X60 VADO ANTRASIT REC
K90153600001VTE0	K901536	M30X60 VADO BEYAZ
K901536R0001VTE0	K901536R	M30X60 VADO BEYAZ REC
K90154000001VTE0	K901540	M30X60 VADO MOKA
K901540R0001VTE0	K901540R	M30X60 VADO MOKA REC
K90155100001VTE0	K901551	M30X60 VADO SOFT KAHVE
K901551R0001VTE0	K901551R	M30X60 VADO SOFT KAHVE REC
K901573R0001VTE0	K901573R	M60X60 VADO ANTRASIT REC
K901584R0001VTE0	K901584R	M60X60 VADO GRI REC
K901595R0001VTE0	K901595R	M60X60 VADO BEYAZ REC
K901606R0001VTE0	K901606R	M60X60 VADO MOKA REC
K901610R0001VTE0	K901610R	M60X60 VADO SOFT KAHVE REC
K90169100001VTE0	K901691	M8.5x60 VADO ANTRASIT SUP
K901621R0001VTE0	K901621R	M60X60 VADO BEJ REC
K90163200001VTE0	K901632	M45X45 VADO ANTRASIT.
K90171300001VTE0	K901713	M8.5x60 VADO BEYAZ SUP
K90164300001VTE0	K901643	M45X45 VADO GRI
K90165400001VTE0	K901654	M45X45 VADO BEYAZ
K90166500001VTE0	K901665	M45X45 VADO MOKA
K90175000001VTE0	K901750	M8.5x45 VADO ANTRASIT SUP
K90167600001VTE0	K901676	M45X45 VADO SOFT KAHVE
K90182000001VTE0	K901820	M45X45 VADO GRI BSMK
K90176100001VTE0	K901761	M8.5x45 VADO GRI SUP

Ürün Kodları / Product Codes

Yeni Ürün Kodu / New Product Code	Eski Ürün Kodu / Previous Product Code	Açıklama / Description
K90168000001VTE0	K901680	M45X45 VADO BEJ
K90183100001VTE0	K901831	M45X45 VADO BEYAZ BSMK
K90177200001VTE0	K901772	M8.5x45 VADO BEYAZ SUP
K90454100001VTE0	K904541	M30x30 VADO GRI
K90178300001VTE0	K901783	M8.5x45 VADO MOKA SUP
K90455200001VTE0	K904552	M30x30 VADO BEYAZ
K90179400001VTE0	K901794	M8.5x45 VADO SOFT KAHVE SUP
K90456300001VTE0	K904563	M30x30 VADO SOFT KAHVE
K90186400001VTE0	K901864	M45X45 VADO BEJ BSMK
K90180500001VTE0	K901805	M8.5x45 VADO BEJ SUP
K90457400001VTE0	K904574	M30x30 VADO BEJ
K91926300001VTE0	K919263	7X30 VADO GRI SUP MAT
K90458500001VTE0	K904585	M30x30 VADO MOKA
K91927400001VTE0	K919274	7X30 VADO BEYAZ SUP MAT
K90459600001VTE0	K904596	M30x30 VADO ANTRASIT
K91928500001VTE0	K919285	7X30 VADO SOFT KAHVE SUP MAT
K91851500001VTE0	K918515	33X33 VADO GRI
K91751300001VTE0	K917513	7X30 VADO BEJ SUP MAT
K91852600001VTE0	K918526	33X33 VADO BEYAZ
K91929600001VTE0	K919296	7X30 VADO MOKA SUP MAT
K91853000001VTE0	K918530	33X33 VADO AKAHVE
K91930000001VTE0	K919300	7X30 VADO ANTRASIT SUP MAT
K91854100001VTE0	K918541	33X33 VADO BEJ
K91855200001VTE0	K918552	33X33 VADO MOKA
K91857400001VTE0	K918574	8x33 VADO GRI SUP
K91856300001VTE0	K918563	33X33 VADO ANTRASIT
K91858500001VTE0	K918585	8x33 VADO BEYAZ SUP
K93742600001VTE0	K937426	M45X45 VADO SOFT KAHVE R10 B
K91859600001VTE0	K918596	8x33 VADO AKAHVE SUP
K94315300001VTE0	K943153	M45X45 VADO BEYAZ MAT R10B
K91860000001VTE0	K918600	8x33 VADO BEJ SUP
K94331900001VTE0	K943319	M45X45 VADO GRI R10B
K91861100001VTE0	K918611	8x33 VADO MOKA SUP
K94332000001VTE0	K943320	M45X45 VADO BEJ R10B
K91862200001VTE0	K918622	8x33 VADO ANTRASIT SUP
K94332200001VTE0	K943322	M45X45 VADO ANTRASIT R10B
K94332300001VTE0	K943323	M45X45 VADO MOKA R10B
WOODMIX		
K943048R0001VTE0	K9430487R	M20X120 WOODMIX BEJ R10 7REC
K943049R0001VTE0	K9430497R	M30X120 WOODMIX BEJ R10 7REC
K946477R0001VTE0	K9464777R	M60X120 WOODMIX BEJ R10 7REC
K943051R0001VTE0	K9430517R	M20X120 WOODMIX MOKA R10 7REC
K943053R0001VTE0	K9430537R	M30X120 WOODMIX MOKA R10 7REC
K946478R0001VTE0	K9464787R	M60X120 WOODMIX MOKA R10 7REC
K943055R0001VTE0	K9430557R	M20X120 WOODMIX GRI R10 7REC
K943056R0001VTE0	K9430567R	M30X120 WOODMIX GRI R10 7REC
K946479R0001VTE0	K9464797R	M60X120 WOODMIX GRI R10 7REC
K944422R0001VTE0	K9444227R	M20X120 WOODMIX ANTRASIT R10 7REC

Yeni Ürün Kodu / New Product Code	Eski Ürün Kodu / Previous Product Code	Açıklama / Description
K944424R0001VTE0	K9444247R	M30X120 WOODMIX ANTRASIT 7R10 REC
K946480R0001VTE0	K9464807R	M60X120 WOODMIX ANTRASIT 7R10 REC
K944423R0001VTE0	K9444237R	M20X120 WOODMIX KREM R10 7REC
K944425R0001VTE0	K9444257R	M30X120 WOODMIX KREM R10 7REC
K946481R0001VTE0	K9464817R	M60X120 WOODMIX KREM R10 7REC
K0862228R001VTE0	K086222R	M30X60 WOODMIX ANTRASIT KESME DEK REC
K0861618R001VTE0	K086161R	M30X60 WOODMIX BEJ KESME DEK REC
K0861628R001VTE0	K086162R	M30X60 WOODMIX MOKA KESME DEC REC
K9430578R001VTE0	K943057R	M30X60 WOODMIX GRI KESME DEK REC
K0862238R001VTE0	K086223R	M30X60 WOODMIX KREM KESME DEK REC
WOODPLUS		
K90923100001VTE0	K909231	M15X90 WOODPLUS VENGE MAT R10
K909231R0001VTE0	K909231R	M15X90 WOODPLUS WENGE MAT REC R10
K90924200001VTE0	K909242	M15X90 WOODPLUS OAK MAT R10
K909242R0001VTE0	K909242R	M15X90 WOODPLUS OAK MAT REC R10
K90925300001VTE0	K909253	M15X90 WOODPLUS LOAK MAT R10
K909253R0001VTE0	K909253R	M15X90 WOODPLUS LOAK MAT REC R10
K90926400001VTE0	K909264	M15X90 WOODPLUS CEVIZ MAT R10
K909264R0001VTE0	K909264R	M15X90 WOODPLUS WALNUT MAT REC R10
K93298300001VTE0	K932983	M15x90 WOODPLUS BEYAZ R10
K932983R0001VTE0	K932983R	M15x90 WOODPLUS BEYAZ REC R10
K93299400001VTE0	K932994	M15x90 WOODPLUS K.GRI R10
K932994R0001VTE0	K932994R	M15x90 WOODPLUS K.GRI REC R10
K93300500001VTE0	K933005	M15x90 WOODPLUS ANTRASIT R10
K933005R0001VTE0	K933005R	M15x90 WOODPLUS ANTRASIT REC R10

Headquarters Genel Merkez

VitrA Karo San. Ve Tic. A.Ş.

Büyükdere Cad. Ali Kaya Sok. No: 5
Levent 34394 İstanbul
Phone: +(90 212) 350 80 00
Fax: +(90 212) 350 85 58

Regional Offices Bölge Ofisleri

VitrA UK Ltd.

Park 34 Collet Way,
Didcot Oxon Ox11 7WB, UK
Phone: +44 (1235) 750 990
Fax: +44 (1235) 750 985

VitrA Fliesen GmbH-Co. KG.

Brucknerstrasse 43
56566 Neuwied, Germany
Phone: +49 (2622) 7007-0
Fax: +49 (2622) 7007-60

VitrA Plitka LLC

142253, bld. 1, Bolshevik Settlement,
Serpukhov District, Moscow Region Russia
Phone: +7 (496) 738 06 08
Fax: +7 (495) 520 78 76

Flagship Showrooms Flagship Mağazalar

VitrA Nişantaşı

Vali Konağı Cad. No: 24 Nişantaşı
Şişli / İstanbul
Phone: +90 (212) 233 07 78
Fax: +90 (212) 232 94 67

VitrA Suadiye

Bostancı Mah. Bağdat Cad. Cavit Paşa Köşkü
No: 493-1 34744 Kadıköy / İstanbul
Phone: +90 (216) 467 06 40

VitrA Cologne

Agrippinawerft 24
D-50678 Köln, Cologne
Phone: +49 (221) 27 73 68-0
Fax: +49 (2622) 88 95 500

VitrA Moscow

Varshavskoe Highway, 9, Bld.1
“Danilovskaya Manufakruta” Office Center
117105 Moscow
Phone / Fax: +7 (495) 221 76 11

Attention - Dikkat

When ordering ceramic tiles specify the areas of use.
Before tile setting, verify the tonality and calibration numbers, claims regarding these indications cannot be accepted after tile setting.
Crazing of glass borders is a nature of the ceramic tiles.
It is recommended to use VitrA Fix grout and adhesive materials with VitrA Ceramic Tiles.
The colors of tiles in the catalogue may not reflect the exact colors of the products.
For items with complimentary parts or decors, there may occur color tone diversity with plain background.
VitrA Karo San. ve Tic. A.Ş. reserves the right to change the products and technical specifications.

Seramik karoları sipariş ederken kullanım alanlarını belirtiniz.
Seramik karoları döşemeden önce lütfen tonalite ve kalibre numaralarının aynı mekânlar için aynı olmasına dikkat ediniz; döşendikten sonra sorumluluk kabul edilmez.
Camı bordürlerde Kraküle (çatlama) olabilir, seramiğin doğasında olan bir unsurdur.
VitrA Karo Seramikleri ile birlikte VitrA Fix derz dolgu ve yapıştırıcı malzemeleri kullanılması önerilir.
Katalogdaki ürün renkleri seramik karoların renklerini aynen yansıtmayabilir.
Tamamlayıcı parçası veya dekoru olan ürünlerde ana fonu ile ton farklılıkları görülebilir.
VitrA Karo San. ve Tic. A.Ş.'nin ürünler ve teknik detaylarında değişiklik yapma hakkı saklıdır.

VitrA