

A high-angle photograph of a swimming pool. The pool is filled with clear blue water, and several lane lines are visible, alternating between dark blue and yellow. In the foreground, a white diving board is partially visible, with its metal handrails extending into the water. The pool deck is made of light-colored square tiles. The overall scene is bright and clean.

VitrA

PRO
SOLUTIONS

POOL

PRO
SOLUTIONS

POOL

PRO

VitrA, mimarlara ve iç mimarlara ilham verecek, profesyonellerin hayallerini tasarımlarına yardımcı olacak, sayısız ürün, renk, desen, malzeme, yüzey özelliği ve çözüm barındıran VitrA PRO karo seramik koleksiyonunu daha da zenginleştirdi.

VitrA PRO karo seramik koleksiyonunda; doğadan ilham alan malzeme seçenekleri ile PRO Nature, renk çeşitliliği, farklı yüzeyler ve dayanıklılık sunan PRO Technic ve bu ikisinden seçilmiş ürünlerle, kullanım yerine özel havuz ve dış cephe çözümlerini bir araya getiren PRO Solutions bulunuyor.

VitrA further enriched its VitrA PRO ceramic tile collection featuring numerous products, colors, patterns, materials, surface textures and solutions, which will inspire architects and interior designers and help the professionals to design their dreams.

Included in VitrA PRO ceramic tile collection are PRO Nature with material alternatives inspired by nature, PRO Technic with color diversity, different surfaces and durability, in addition to PRO Solutions with site-specific solutions for pools and facades with products collated from these two lines.

PRO NATURE

Doğal malzeme dokulu karolar
Natural material textured tiles

Ahşap / Wood

Taş / Stone

Mermer / Marble

Beton / Concrete

Seramik / Ceramic

PRO TECHNIC

Renkler, yüzeyler, fullbody
porselenler ve teknik karolar

Colors, surfaces, fullbody
porcelains and technic tiles

Color

Function

Matrix

PRO SOLUTIONS

PRO Nature ve PRO Technic ürünlerinden oluşturulmuş
entegre karo çözümleri.

Integrated tiles solutions collated from PRO Nature and
PRO Technic products.

Pool

Facade

PRO

SOLUTIONS

POOL

Havuz Sistemleri	10
Pool Systems	
Fin Sistemi / Finnish Overflow System	
Üstten Taşmalı / High Water Level	14
Üstten Taşmalı / High Water Level	20
Üstten Taşmalı - Izgara Ayaklı / High Water Level - With Channel Edge	28
Üstten Taşmalı - Merdiven Parçaları / High Water Level - Ladder Stair Pieces	34
Üstten Taşmalı - Tırtıklı Parçalar / High Water Level - Ribbed Tiles	38
Wiesbaden Sistemi / System Wiesbaden	
Üstten Taşmalı - Geniş Kanal / High Water Level Overflow - Wide Channel	48
Üstten Taşmalı - Dar Kanal / High Water Level Overflow - Narrow Channel	56
İçten Taşmalı - Izgarasız Geniş Kanal / Low Water Level Overflow - Wide Channel Without Grate	62
İçten Taşmalı - Izgarasız Dar Kanal / Low Water Level Overflow - Narrow Channel Without Grate	68
Zürih Sistemi / System Zurich	
Üstten Taşmalı / High Water Level Overflow	74
Özel Parçalar / Special Moulded Trims	78
Havuz Karoları	89
Pool Tiles	
PRO Color	101
Mix	116
PRO Color Renklere Göre Ebat Dizilimi / PRO Color Size Options In Color Order	118

İÇİNDEKİLER

INDEX

PRO Color Tamamlayıcı Parçalar / PRO Color Complementary Parts	128
PRO Color Tablo / PRO Color Table	132
Color ve Uni Uyum Tablosu / Color and Uni Matching Table	134
PRO Function	139
PRO Function Renklere Göre Ebat Dizilimi / PRO Function Size Options In Color Order	148
PRO Function Tamamlayıcı Parçalar / PRO Function Complementary Parts	152
PRO Matrix	173
Matrix Flake	187
Özel Yüzeyle Karolar Special Surfaces Tiles	193
Proje Hizmetleri Project Services	205
VitrA' dan Projelerinize Özel Yaratıcı Çözümler / VitrA's Creative Solutions Special For Your Projects	207
Referanslar References	209
Teknik Bilgiler Technical Information	215

PRO
SOLUTIONS

POOL

SUYU ŐEKİLLENDİREREK HAYALLERİNİ TASARLA

Suya hayalindeki formu kazandır. Fonksiyonel ve estetik havuzlar tasarlarken suya Őekil veren, onun rengini ve ıřılıtısını güçlendiren tasarımlar ortaya çıkar.

VitrA, PRO Solutions Pool karo seramiklerinde; havuzlara estetik deęer ve fonksiyonel üstünlükler katan havuz karoları ile iten veya üstten tařmalı kanal sistemleri uygulanan farklı havuz tiplerine uygun tasarım çözümleri sunar.

PRO Solutions Pool koleksiyonu; kapalı havuzlar, açık hava havuzları, SPA havuzları, kaplıca tedavi havuzları, tıbbi havuzlar, okul havuzları, profesyonel havuzlar, spor havuzları, dinlenme havuzları ve eęlence havuzları gibi pek çok farklı havuz projesine özel ürünler ve tamamlayıcı paralar ierir.

DESIGN YOUR DREAMS, SHAPING WATER

Frame water into the form in your dreams. Create designs that shape the water and galvanize its color and glimmer as you design functional and aesthetic pools.

In PRO Solutions Pool tiles, VitrA offers design solutions for different types of pools where bottom and overflow drainage systems are applied, with the pool tiles adding the pools an aesthetic value and functional advantages.

PRO Solutions Pool collection includes exclusive solutions and supplementary components for a great number of different pool projects such as indoor pools, outdoor pools, SPA pools, thermal treatment pools, medical pools, school pools, professional pools, sports pools, resting pools and leisure/recreational pools.

HAVUZ SİSTEMLERİ
POOL SYSTEMS

HAVUZ KAROLARI
POOL TILES

TEKNİK PORSELEN KAROLAR
TECHNICAL PORCELAIN TILES

PROJE HİZMETLERİ
PROJECT SYSTEMS

REFERANSLAR
REFERENCES

TEKNİK BİLGİLER
TECHNICAL INFORMATION



POOL SYSTEMS

HAVUZ SİSTEMLERİ

HAVUZ SİSTEMLERİ

POOL SYSTEMS

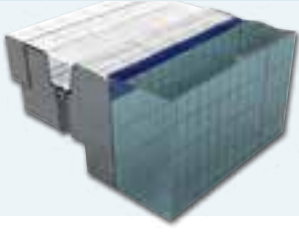

Fin Sistemi

Üstten Taşmalı

Finnish Overflow

System high water level overflow



Fin Sistemi

Üstten Taşmalı

Finnish Overflow

System high water level overflow

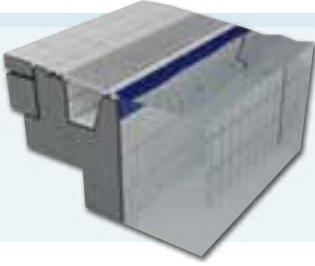

Fin Sistemi

Üstten Taşmalı - Izgara Ayaklı

Finnish Overflow

System High Water Level - With Channel Edge



Fin Sistemi

Üstten Taşmalı - Merdiven Parçaları

Finnish Overflow

System High Water Level - Ladder Stair Pieces

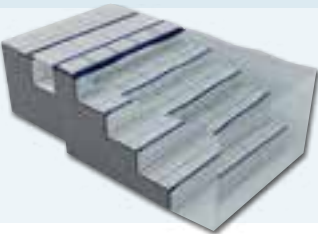

Fin Sistemi

Üstten Taşmalı - Tırtıklı Parçalar

Finnish Overflow

System High Water Level - Ribbed Tiles

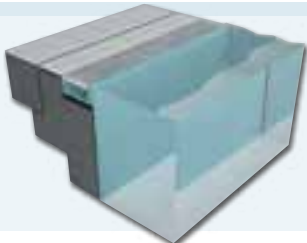

Wiesbaden Sistemi

Üstten Taşmalı - Geniş Kanal

System Wiesbaden

High Water Level Overflow - Wide Channel

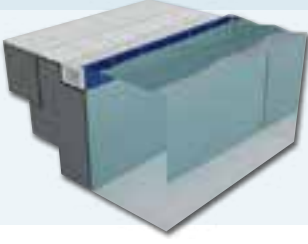

Wiesbaden Sistemi

Üstten Taşmalı - Dar Kanal

System Wiesbaden

High Water Level Overflow - Narrow Channel

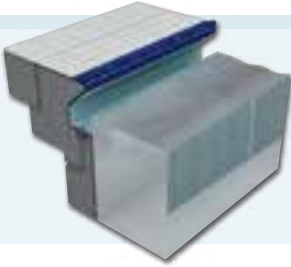

Wiesbaden Sistemi

İçten Taşmalı - Izgarasız Geniş Kanal

System Wiesbaden

Low Water Level Overflow - Wide Channel Without Grate

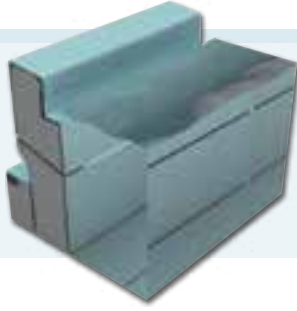

Wiesbaden Sistemi

İçten Taşmalı - Izgarasız Dar Kanal

System Wiesbaden

Low Water Level Overflow - Narrow Channel Without Grate

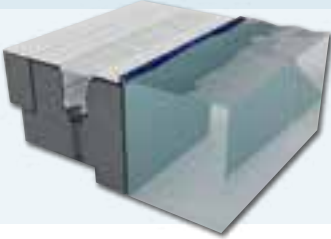

Zürih Sistemi

Üstten Taşmalı

System Zurich

High Water Level Overflow

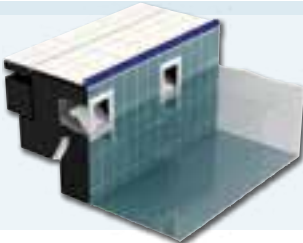

Skimmer Sistemi

İçten Taşmalı

System Skimmer

Low Water Level Overflow

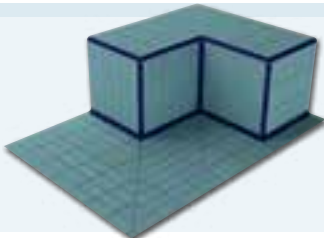

Özel parçalar

Special Moulded Trims

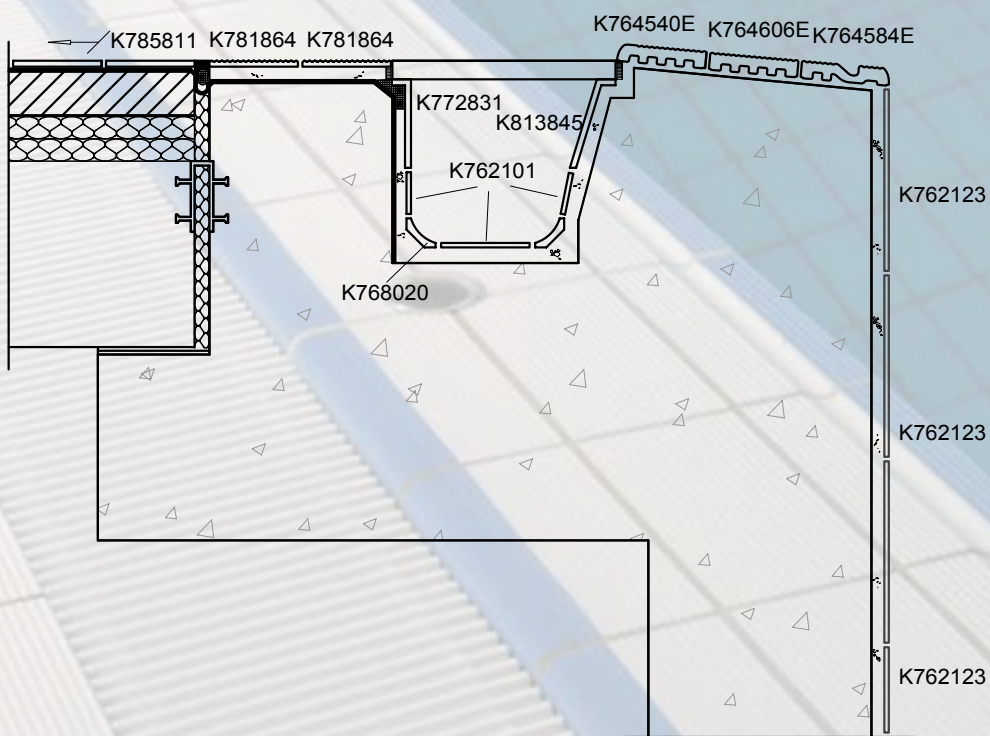
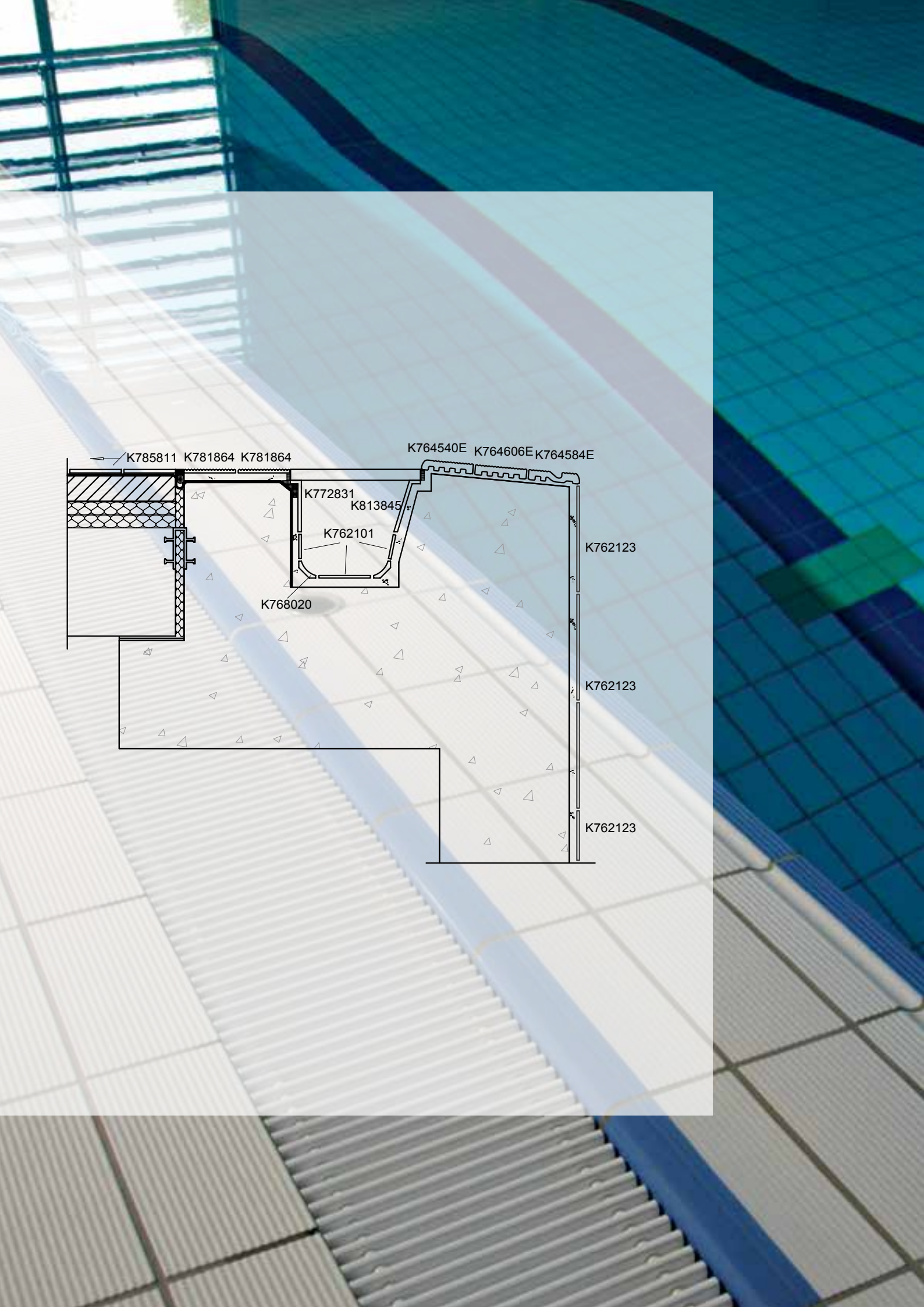

PRO POOL
SOLUTIONS

















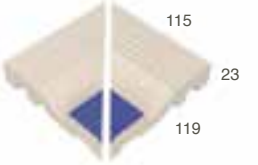





FİN SİSTEMİ **FINNISH OVERFLOW SYSTEM**

ÜSTTEN TAŞMALI
HIGH WATER LEVEL



Fin Sistemi Üstten Taşmalı Finnish Overflow System High Water Level

	Parlak Glossy	Mat Matt		Ölçü Dimension	Adet/m Pieces/m	Adet/Kutu Pieces/Box	m ² /Kutu m ² /Box	kg/Kutu kg/Box
				M 12.5x25 cm 119x244x23 mm				
RAL 5002	K764595E	K764584E	C 		4	8		9.60
RAL 2307015	K764573E	K764562E	C 		4	8		9.60
RAL 5002 R10B		K945917E	C 		4	8		9.60
RAL 0001500 R10B		K945898E	C 		4	8		9.60
RAL 9016 R10B - RAL 5002 R10B		K885960E	R10B		4	8		9.60
RAL 9016 R10B - RAL 0001500 R10B		K945923E	R10B		4	8		9.60
				M 12.5x12.5 cm 119x119x23 mm				
RAL 5002	K880274E	K880263E	C 		4	16		9.60
RAL 2307015	K880296E	K880285E	C 		4	16		9.60
				M 12.5x25 cm 119x244x23 mm				
RAL 5002	K778444	K778433	C 		4	8		7.20
RAL 2307015	K778466	K778455	C 		4	8		7.20
RAL 5002 R10B		K945920	C 		4	8		7.20
RAL 0001500 R10B		K945901	C 		4	8		7.20
RAL 9016 R10B - RAL 5002 R10B		K945905	R10B		4	8		7.20
RAL 9016 R10B - RAL 0001500 R10B		K945926	R10B		4	8		7.20
				M 12.5x25 cm 119x244x23 mm				
RAL 5002	K778481	K778470	C 		4	8		7.20
RAL 2307015	K778503	K778492	C 		4	8		7.20
RAL 5002 R10B		K945921	C 		4	8		7.20
RAL 0001500 R10B		K945902	C 		4	8		7.20
RAL 9016 R10B - RAL 5002 R10B		K945922	R10B		4	8		7.20
RAL 9016 R10B - RAL 0001500 R10B		K945927	R10B		4	8		7.20

	Parlak Glossy	Mat Matt		Ölçü Dimension	Adet/m Pieces/m	Adet/Kutu Pieces/Box	m ² /Kutu m ² /Box	kg/Kutu kg/Box
	23			M 12.5x25 cm 119x244x23 mm				
RAL 5002	K769926E	K769930E	C 		4	8		9.60
RAL 2307015	K769904E	K769915E	C 		4	8		9.60
RAL 5002 R10B		K945976E	C 		4	8		9.60
RAL 0001500 R10B		K945975E	C 		4	8		9.60
RAL 9016 R10B - RAL 5002 R10B		K945977E	R10B		4	8		9.60
RAL 9016 R10B - RAL 0001500 R10B		K945989E	R10B		4	8		9.60
	23			M 12.5x12.5 cm 119x119x23 mm				
RAL 5002	K764735E	K764724E	C 			4		2.80
RAL 2307015	K764713E	K764702E	C 			4		2.80
RAL 5002 R10B		K945918E	C 			4		2.80
RAL 0001500 R10B		K945899E	C 			4		2.80
RAL 9016 R10B - RAL 5002 R10B		K945903E	R10B			4		2.80
RAL 9016 R10B - RAL 0001500 R10B		K945924E	R10B			4		2.80
	23			M 12.5x12.5 cm 119x150x23 mm				
RAL 5002	K772466	K772455	C 			4		2.75
RAL 2307015	K772481	K772470	C 			4		2.75
	23			M 12.5x12.5 cm 119x119x23 mm				
RAL 5002	K764691E	K764680E	C 			4		2.80
RAL 2307015	K764676E	K764665E	C 			4		2.80
RAL 5002 R10B		K945919E	C 			4		2.80
RAL 0001500 R10B		K945900E	C 			4		2.80
RAL 9016 R10B - RAL 5002 R10B		K945904E	R10B			4		2.80
RAL 9016 R10B - RAL 0001500 R10B		K945925E	R10B			4		2.80
	23			M 12.5x12.5 cm 119x119x23 mm				
RAL 5002	K772503	K772492	C 			4		2.00
RAL 2307015	K772525	K772514	C 			4		2.00





Giaretta Italia

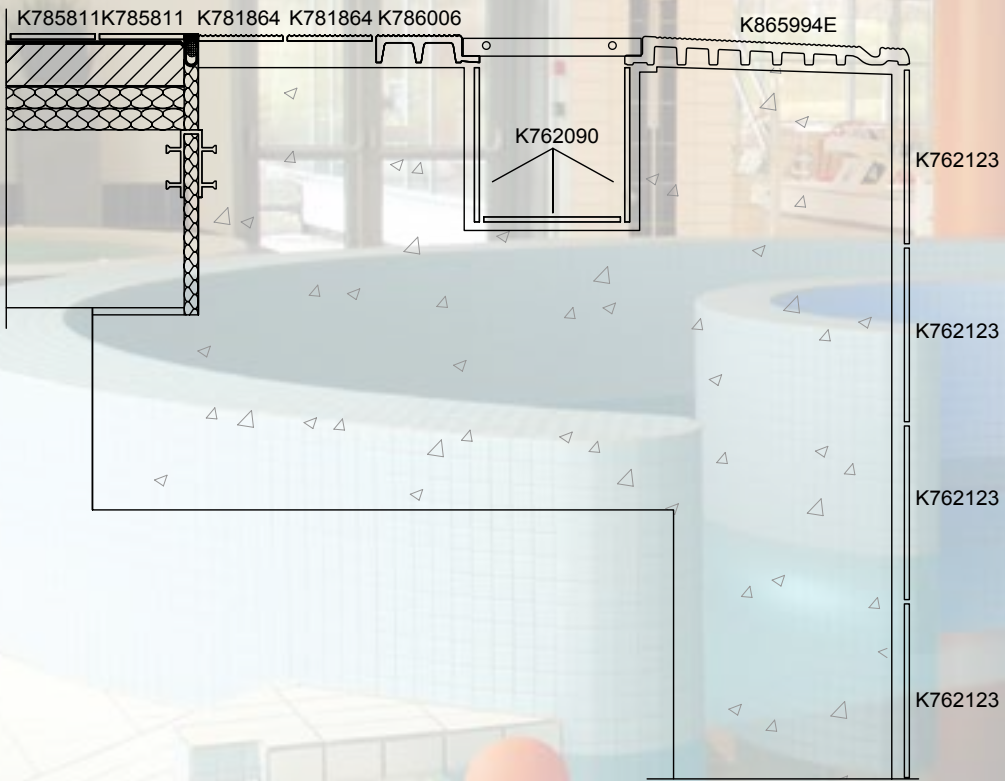
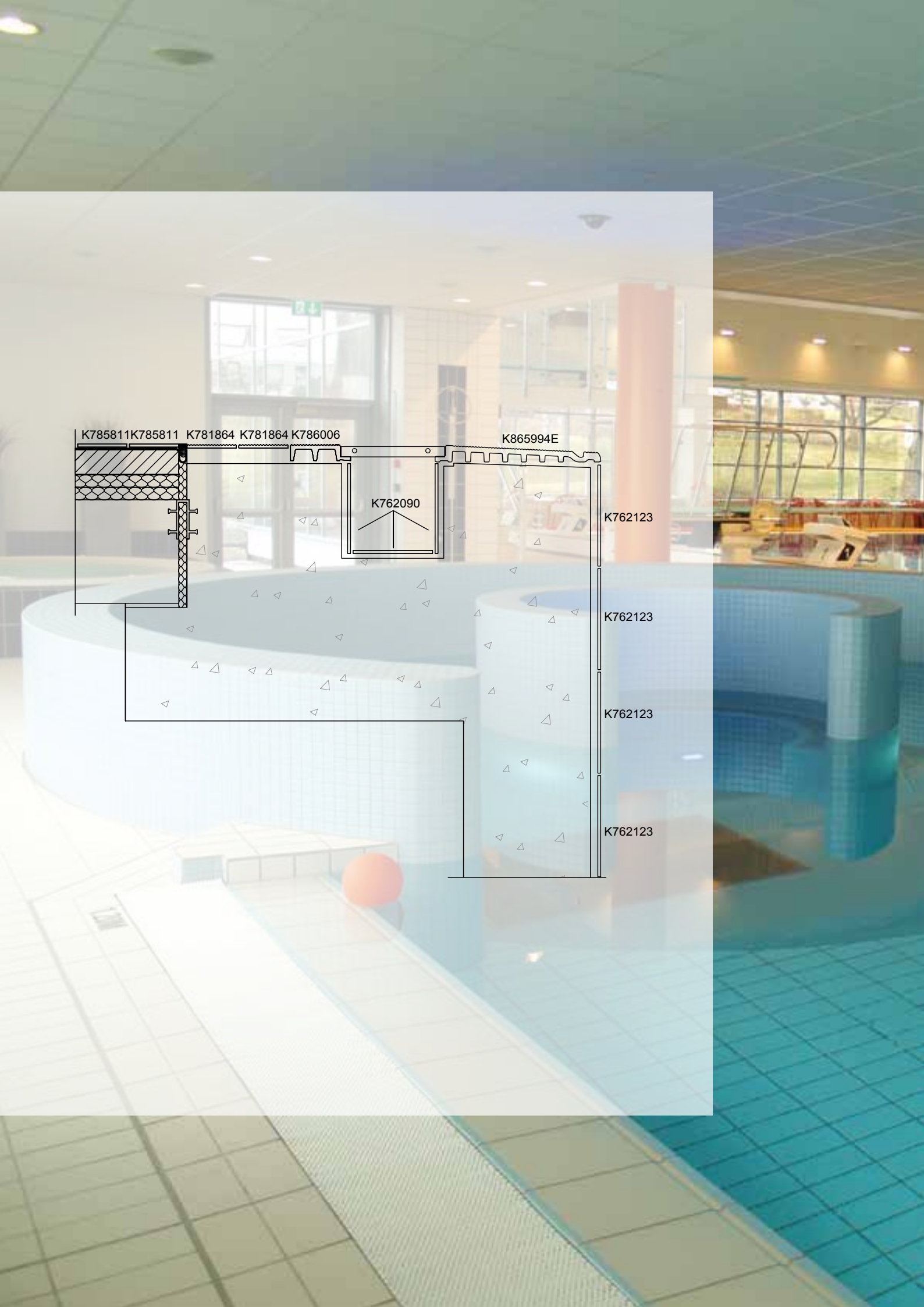



PRO POOL
SOLUTIONS

FİN SİSTEMİ **FINNISH OVERFLOW SYSTEM**

ÜSTTEN TAŞMALI
HIGH WATER LEVEL

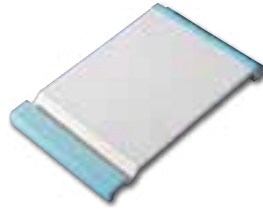









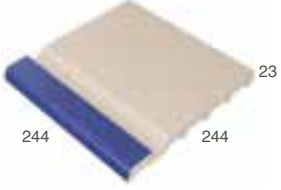



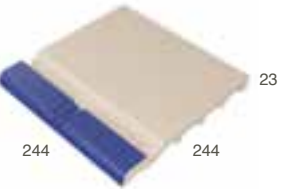

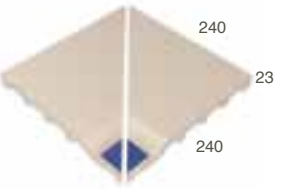

Fin Sistemi Üstten Taşmalı Finnish Overflow System High Water Level



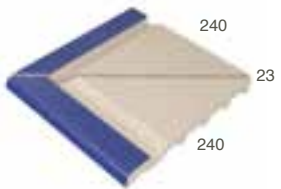







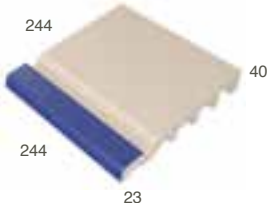







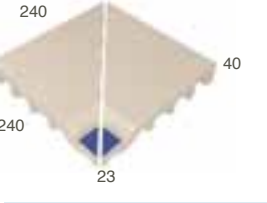

	Parlak Glossy	Mat Matt		Ölçü Dimension	Adet/m Pieces/m	Adet/Kutu Pieces/Box	m²/Kutu m²/Box	kg/Kutu kg/Box
 <p>375 40 244 23</p> <p>Havuz tutamağı eğimli Pool edge with finger grip slope</p>				M 37.5x25 cm 375X244x28/40 mm				
RAL 5002		K867722E	C 		4	5		20.50
 <p>375 40 244 23</p> <p>Oluklu havuz tutamağı eğimli Pool edge with finger grip and outlet slope</p>				M 37.5x25 cm 375X244x28/40 mm				
RAL 5002		K897915E	C 		4	5		20.50
 <p>371 40 371 23</p> <p>Havuz tutamağı iç köşesi eğimli Pool edge with finger grip internal corner slope</p>				M 37.5x37.5 cm 375X375x28/40 mm				
RAL 5002		K867766E	C 			4		22.00
 <p>371 40 371 23</p> <p>Havuz tutamağı dış köşesi eğimli Pool edge with finger grip external corner slope</p>				M 37.5x37.5 cm 375X375x28/40 mm				
RAL 5002		K867803E	C 			4		22.00



Fin Sistemi Üstten Taşmalı Finnish Overflow System High Water Level





















	Parlak Glossy	Mat Matt		Ölçü Dimension	Adet/m Pieces/m	Adet/Kutu Pieces/Box	m ² /Kutu m ² /Box m ² /Boite	kg/Kutu kg/Box
				M 25x25 cm 244X244x23 mm				
RAL 5002	K898162E		C 		4	8		18.00
RAL 2307015	K898184E		C 		4	8		18.00
RAL 5002 R10B		K946129E	C 		4	8		18.00
RAL 0001500 R10B		K946120E	C 		4	8		18.00
RAL 9016 R10B - RAL 5002 R10B		K946122E	R10B		4	8		18.00
RAL 9016 R10B - RAL 0001500 R10B		K945990E	R10B		4	8		18.00
				M 25x25 cm 244X244x23 mm				
RAL 5002	K898206E		C 		4	8		18.00
RAL 2307015	K898221E		C 		4	8		18.00
RAL 5002 R10B		K946130E	C 		4	8		18.00
RAL 0001500 R10B		K946121E	C 		4	8		18.00
RAL 9016 R10B - RAL 5002 R10B		K946123E	R10B		4	8		18.00
RAL 9016 R10B - RAL 0001500 R10B		K946126E	R10B		4	8		18.00
				M 25x25 cm 244X244x23 mm				
RAL 5002	K898246E		C 			4		9.40
RAL 2307015	K898261E		C 			4		9.40
RAL 5002 R10B		K946132E	C 			4		9.40
RAL 0001500 R10B		K945993E	C 			4		9.40
RAL 9016 R10B - RAL 5002 R10B		K946125E	R10B			4		9.40
RAL 9016 R10B - RAL 0001500 R10B		K946128E	R10B			4		9.40
				M 25x25 cm 244X244x23 mm				
RAL 5002	K898283E		C 			4		9.40
RAL 2307015	K898305E		C 			4		9.40
RAL 5002 R10B		K946131E	C 			4		9.40
RAL 0001500 R10B		K945992E	C 			4		9.40
RAL 9016 R10B - RAL 5002 R10B		K946124E	R10B			4		9.40
RAL 9016 R10B - RAL 0001500 R10B		K946127E	R10B			4		9.40

Fin Sistemi Üstten Taşmalı Finnish Overflow System High Water Level



	Parlak Glossy	Mat Matt		Ölçü Dimension	Adet/m Pieces/m	Adet/Kutu Pieces/Box	m ² /Kutu m ² /Box	kg/Kutu kg/Box
	Havuz tutamağı eğimli Pool edge with finger grip slope			M 25x25 cm 244X250x28/40 mm				
RAL 5002	K867615E	K867604E	C 		4	5		13.50
RAL 2307015	K867630E	K867626E	C 		4	5		13.50
RAL 5002 R10B		K946029E	C 		4	5		13.50
RAL 0001500 R10B		K946025E	C 		4	5		13.50
RAL 9016 R10B - RAL 5002 R10B		K946043E	R10B		4	5		13.50
RAL 9016 R10B - RAL 0001500 R10B		K946033E	R10B		4	5		13.50
	Oluklu tutamak eğimli Channel edge with finger grip and outlet slope			M 25x25 cm 244X250x28/40 mm				
RAL 5002	K896482E	K896504E	C 		4	5		13.50
RAL 2307015	K896493E	K896515E	C 		4	5		13.50
RAL 5002 R10B		K946032E	C 		4	5		13.50
RAL 0001500 R10B		K946028E	C 		4	5		13.50
RAL 9016 R10B - RAL 5002 R10B		K946046E	R10B		4	5		13.50
RAL 9016 R10B - RAL 0001500 R10B		K946042E	R10B		4	5		13.50
	Havuz tutamağı iç köşesi eğimli Pool edge with finger grip internal corner slope			M 25x25 cm 250X250x28/40 mm				
RAL 5002	K867652E	K867641E	C 			4		11.60
RAL 2307015	K867674E	K867663E	C 			4		11.60
RAL 5002 R10B		K946031E	C 			4		11.60
RAL 0001500 R10B		K946027E	C 			4		11.60
RAL 9016 R10B - RAL 5002 R10B		K946045E	R10B			4		11.60
RAL 9016 R10B - RAL 0001500 R10B		K946041E	R10B			4		11.60
	Havuz tutamağı dış köşesi eğimli Pool edge with finger grip external corner slope			M 25x25 cm 250X250x28/40 mm				
RAL 5002	K867696E	K867685E	C 			4		10.40
RAL 2307015	K867711E	K867700E	C 			4		10.40
RAL 5002 R10B		K946030E	C 			4		10.40
RAL 0001500 R10B		K946026E	C 			4		10.40
RAL 9016 R10B - RAL 5002 R10B		K946044E	R10B			4		10.40
RAL 9016 R10B - RAL 0001500 R10B		K946040E	R10B			4		10.40

Fin Sistemi Izgara Ayaklı

Finnish Overflow System High Water Level - With Ohannel Edge

	Parlak Glossy	Mat Matt		Ölçü Dimension	Adet/m Pieces/m	Adet/Kutu Pieces/Box	m²/Kutu m²/Box	kg/Kutu kg/Box
	Izgara ayaklı tutamak eğimli Channel edge with finger grip slope			M 25x25 cm 275X244x28/40 mm				
RAL 5002	K865880E	K865876E	C 		4	5		15.00
RAL 2307015	K865902E	K865891E	C 		4	5		15.00
RAL 5002 R10B		K946137E	C 		4	5		15.00
RAL 0001500 R10B		K946133E	C 		4	5		15.00
RAL 9016 R10B - RAL 5002 R10B		K946145E	R10B		4	5		15.00
RAL 9016 R10B - RAL 0001500 R10B		K946141E	R10B		4	5		15.00
	Izgara ayaklı oluklu tutamak eğimli Channel edge with finger grip and outlet slope			M 25x25 cm 275X244x28/40 mm				
RAL 5002	K898320E	K898316E	C 		4	5		15.00
RAL 2307015	K898342E	K898331E	C 		4	5		15.00
RAL 5002 R10B		K946140E	C 		4	5		15.00
RAL 0001500 R10B		K946136E	C 		4	5		15.00
RAL 9016 R10B - RAL 5002 R10B		K946148E	R10B		4	5		15.00
RAL 9016 R10B - RAL 0001500 R10B		K946144E	R10B		4	5		15.00
	Izgara ayaklı tutamak iç köşesi eğimli Channel edge with finger grip internal corner slope			M 25x25 cm 275X275x28/40 mm				
RAL 5002	K865924E	K865913E	C 			4		13.60
RAL 2307015	K865946E	K865935E	C 			4		13.60
RAL 5002 R10B		K946139E	C 			4		13.60
RAL 0001500 R10B		K946135E	C 			4		13.60
RAL 9016 R10B - RAL 5002 R10B		K946147E	R10B			4		13.60
RAL 9016 R10B - RAL 0001500 R10B		K946143E	R10B			4		13.60
	Izgara ayaklı kanal parçası dış köşesi eğimli Channel edge with finger grip external corner slope			M 25x25 cm 275X275x28/40 mm				
RAL 5002	K865931E	K865950E	C 			4		13.60
RAL 2307015	K865983E	K865972E	C 			4		13.60
RAL 5002 R10B		K946138E	C 			4		13.60
RAL 0001500 R10B		K946134E	C 			4		13.60
RAL 9016 R10B - RAL 5002 R10B		K946146E	R10B			4		13.60
RAL 9016 R10B - RAL 0001500 R10B		K946142E	R10B			4		13.60

Fin Sistemi Izgara Ayaklı Finnish Overflow System High Water Level - With Channel Edge

	Parlak Glossy	Mat Matt		Ölçü Dimension	Adet/m Pieces/m	Adet/Kutu Pieces/Box	m²/Kutu m²/Box	kg/Kutu kg/Box
	Izgara ayaklı kanal parçası Channel edge			M 25x25 cm 275x275x40 mm				
RAL 5002 Sırsız. Unglazed. Unglasiert. Non émaillé	K880370E	K880366E K880355E	C  C 		4 4	5 5		12.80 12.80
	Izgara ayaklı kanal parçası iç köşesi Channel edge internal corner			M 25x25 cm 275x275x40 mm				
RAL 5002 Sırsız. Unglazed. Unglasiert. Non émaillé	K881405E	K881394E K881383E	C  C 			4 4		12.40 12.40
	Izgara ayaklı kanal parçası dış köşesi Channel edge external corner			M 25x25 cm 275x275x40 mm				
RAL 5002	K881431E	K881420E	C 			4		13.20



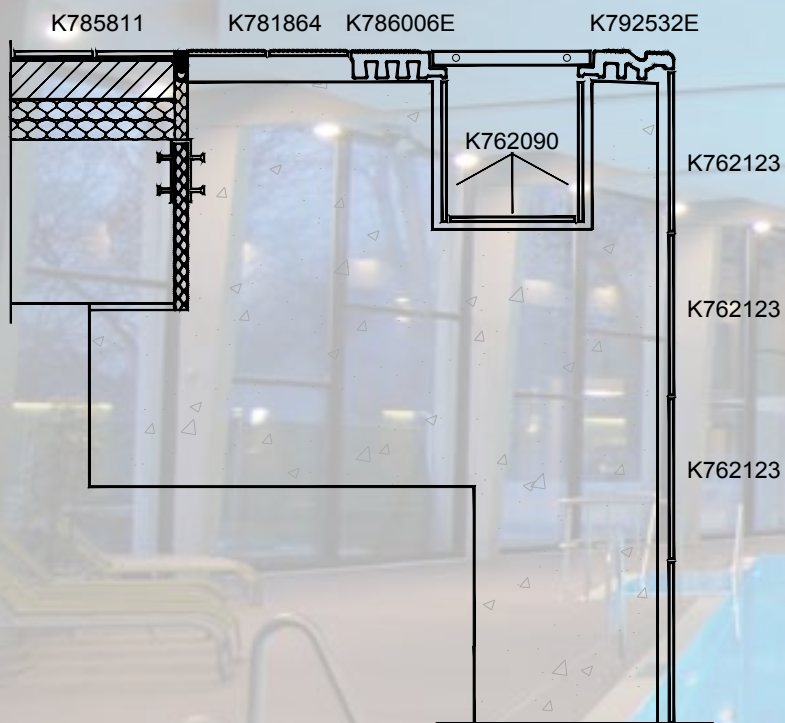







PRO POOL
SOLUTIONS

FİN SİSTEMİ FINNISH OVERFLOW SYSTEM

ÜSTTEN TAŞMALI - IZGARA AYAKLI
HIGH WATER LEVEL - WITH CHANNEL EDGE



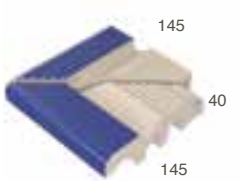



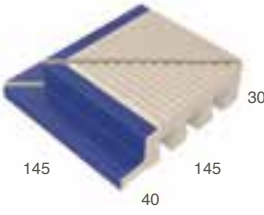

Fin Sistemi Izgara Ayaklı Finnish Overflow System High Water Level - With Channel Edge

	Parlak Glossy	Mat Matt		Ölçü Dimension	Adet/m Pieces/m	Adet/Kutu Pieces/Box	m²/Kutu m²/Box	kg/Kutu kg/Box
 <p>244 40 145</p> <p>Izgara ayaklı tutamak Channel edge with finger grip</p>				M 12.5x25 cm 145x244x40 mm				
RAL 5002	K792532E	K792521E	C 		4	6		9.00
 <p>145 40 145</p> <p>Izgara ayaklı tutamak iç köşesi Channel edge with finger grip internal corner</p>				M 12.5x12.5 cm 145x145x40 mm				
RAL 5002	K792565E	K792554E	C 			4		3.50
 <p>145 40 145</p> <p>Izgara ayaklı tutamak dış köşesi Channel edge with finger grip external corner</p>				M 12.5x12.5 cm 145x145x40 mm				
RAL 5002	K792591E	K792580E	C 			4		3.50
 <p>244 40 145</p> <p>Izgara ayaklı kanal parçası Channel edge</p>				M 12.5x25 cm 145x244x40 mm				
RAL 5002 Sırsız. Unglazed.	K785520E	K786006E K789463E	C  C 		4	6		9.40

	Parlak Glossy	Mat Matt		Ölçü Dimension	Adet/m Pieces/m	Adet/Kutu Pieces/Box	m²/Kutu m²/Box	kg/Kutu kg/Box
								
	Izgara ayaklı kanal parçası iç köşe Channel edge internal corner			M 12.5x12.5 cm 145x145x40 mm				
RAL 5002 Sırsız. Unglazed.	K792451E	K792440E	C 		4	4		4.00
		K790082E	C 		4	4		4.00
								
	Izgara ayaklı kanal parçası dış köşe Channel edge external corner			M 12.5x12.5 cm 145x145x40 mm				
RAL 5002 Sırsız. Unglazed.	K792495E	K792484E	C 		4	4		3.50
		K790093E	C 		4	4		3.50
								
	Izgara ayaklı kanal parçası eğimli Channel edge slope			M 12.5x25 cm 145x244x30/40 mm				
RAL 5002 Sırsız. Unglazed.	K785531E	K786010E	C 		6	6		8.40
		K789452E	C 		6	6		8.40
								
	Izgara ayaklı kanal parçası eğimli iç köşe Channel edge slope internal corner			M 12.5x12.5 cm 145x145x30/40 mm				
Sırsız. Unglazed.		K792425E	C 		4	4		4.00

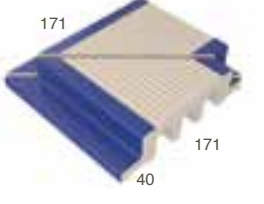
Fin Sistemi Izgara Ayaklı Finnish Overflow System High Water Level - With Channel Edge

	Parlak Glossy	Mat Matt		Ölçü Dimension	Adet/m Pieces/m	Adet/Kutu Pieces/Box	m²/Kutu m²/Box	kg/Kutu kg/Box
 <p>145 30 145 40</p>	Izgara ayaklı kanal parçası eğimli dış köşesi Channel edge slope external corner			M 12.5x12.5 cm 145x145x30/40 mm				
RAL 5002 Sırsız. Unglazed.	K899543E	K899532E K792436E	C 			4		3.50
 <p>244 40 175</p>	Çift ızgara ayaklı kanal parçası Both sided channel edge			M 12.5x25 cm 175x244x40 mm				
RAL 5002 Sırsız. Unglazed.	K880252E	K880241E K880230E	C  C 		4	6		12.60
					4	6		12.60
 <p>171 171 40</p>	Çift ızgara ayaklı kanal parçası köşesi Channel edge both sided corner			M 12.5x12.5 cm 175x175x40 mm				
RAL 5002 Sırsız. Unglazed.	K881372E	K881361E K881350E	C  C 			4		6.00
						4		6.00



8

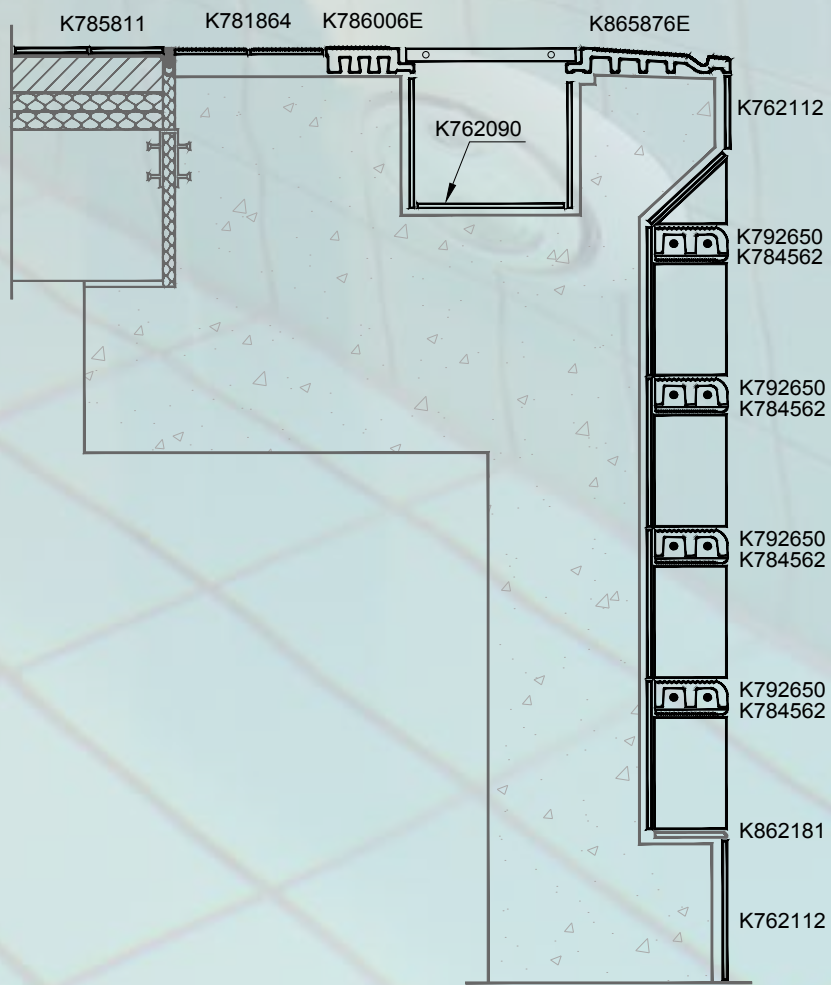
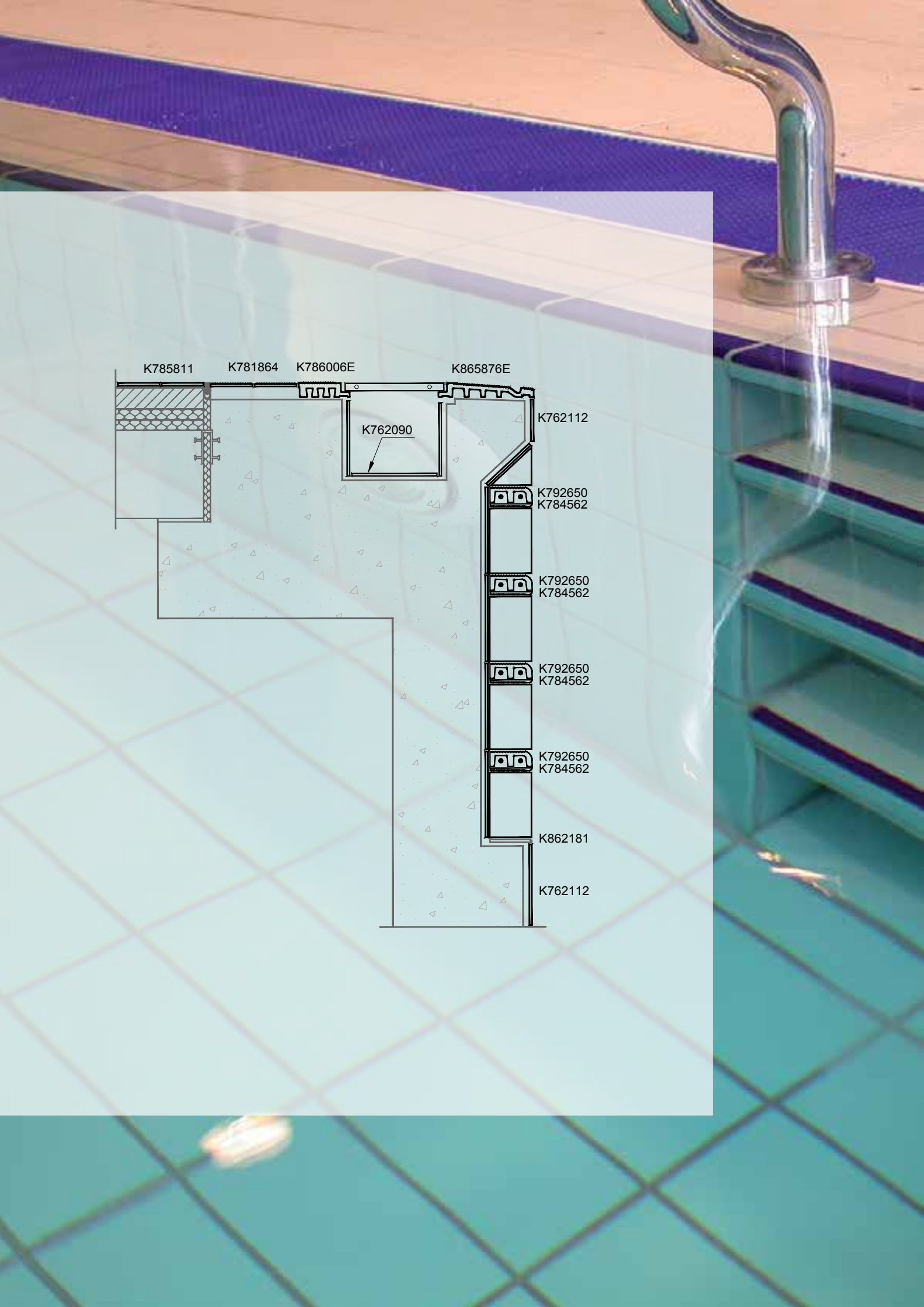









PRO POOL
SOLUTIONS

FİN SİSTEMİ **FINNISH OVERFLOW SYSTEM**

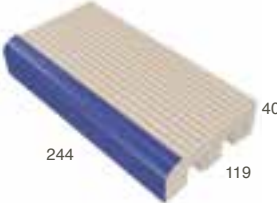
ÜSTTEN TAŞMALI – MERDİVEN PARÇALARI
HIGH WATER LEVEL – LADDER STAIR PIECES



Fin Sistemi Üstten Taşmalı Merdiven Parçaları Finnish Overflow System High Water Level - Ladder Stair Pieces

	Parlak Glossy	Mat Matt		Ölçü Dimension	Adet/m Pieces/m	Adet/Kutu Pieces/Box	m²/Kutu m²/Box	kg/Kutu kg/Box
								
	Merdiven basamağı Ladder stair tile			M 12.5x25 cm 119x244x40 mm				
RAL 5002	K792661E	K792650E	C 		4	4		6.20
RAL 2307015	K792683E	K792672E	C 		4	4		6.20
								
	Havuz kenarı Pool edge			M 12.5x25 cm 119x244x8 mm				
RAL 5002	K785052	K784562	C 		4	20		9.75
RAL 2307015	K791563	K791552	C 		4	20		9.75
								
	Uzun kenar yuvarlak parça Long edge round tile			M 12.5x25 cm 119x244x7 mm				
RAL 5002	K770291	K769146			4	25		11.40
RAL 9016	K770254	K769065			4	25		11.40
RAL 2307015	K770276	K769102			4	25		11.40
RAL 5002		K862166	R10B		4	25		11.40
RAL 9016		K862170	R10B		4	25		11.40
RAL 2307015		K862181	R10B		4	25		11.40



Therme Bad Aibling, GERMANY

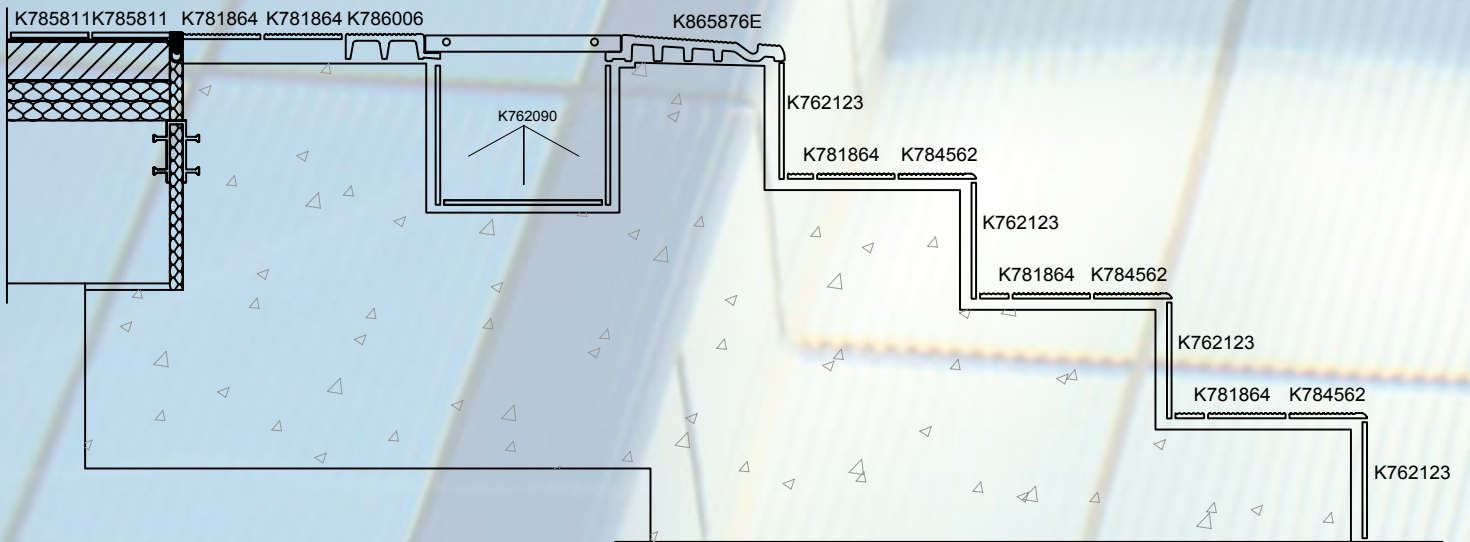

PRO POOL
SOLUTIONS







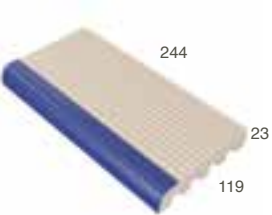

FIN SİSTEMİ **FINNISH OVERFLOW SYSTEM**

ÜSTTEN TAŞMALI - TIRTIKLI PARÇALAR
HIGH WATER LEVEL - RIBBED TILES

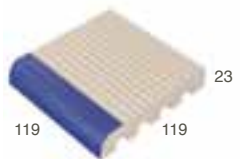

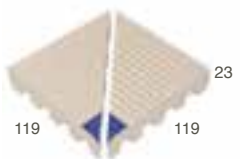
Fin Sistemi Üstten Taşmalı - Tırtıklı Parçalar Finnish Overflow System High Water Level - Ribbed Tiles

	Parlak Glossy	Mat Matt		Ölçü Dimension	Adet/m Pieces/m	Adet/Kutu Pieces/Box	m²/Kutu m²/Box	kg/Kutu kg/Box
								
	Tırtıklı basamak parçası Ribbed tread tile			M 12.5x25 cm 119x244x23 mm				
RAL 5002	K772551	K772540	C 		4	8		8.15
								
	Tırtıklı basamak parçası iç köşesi Ribbed tread tile internal corner			M 12.5x12.5 cm 119x150x23 mm				
RAL 5002	K785973	K785962	C 			4		3.00
								
	Tırtıklı basamak parçası dış köşesi Ribbed tread tile external corner			M 12.5x12.5 cm 119x119x23 mm				
RAL 5002	K785995	K785984	C 			2		2.40

	Parlak Glossy	Mat Matt		Ölçü Dimension	Adet/m Pieces/m	Adet/Kutu Pieces/Box	m²/Kutu m²/Box	kg/Kutu kg/Box
								
RAL 5002	K764551E	K764540E	C 	M 12.5x25 cm 119x244x23 mm	4	8		9.60
								
RAL 5002	K880311E	K880300E	C 	M 12.5x12.5 cm 119x119x23 mm	8	16		9.60
								
RAL 5002	K764654E	K764643E	C 	M 12.5x12.5 cm 119x119x23 mm	4			2.40
								
RAL 5002	K772422E	K772411E	C 	M 12.5x12.5 cm 119x119x23 mm	4			2.40









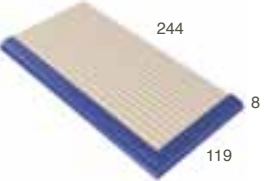

Fin Sistemi Üstten Taşmalı - Tırtıklı Parçalar Finnish Overflow System High Water Level - Ribbed Tiles

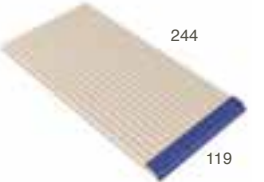
	Parlak Glossy	Mat Matt		Ölçü Dimension	Adet/m Pieces/m	Adet/Kutu Pieces/Box	m ² /Kutu m ² /Box	kg/Kutu kg/Box
 <p>244 23 119</p> <p>Tırtıklı havuz kenarı Ribbed tile</p>				M 12.5x25 cm 119x244x23 mm				
Sırsız, Unglazed.		K764606E	C 		4	8		10.40
 <p>119 23 119</p> <p>Yarım tırtıklı havuz kenarı Half ribbed tile</p>				M 12.5x12.5 cm 119x119x23 mm				
Sırsız, Unglazed.		K880344E	C 		8	16		9.60
 <p>115 23 115</p> <p>Tırtıklı havuz kenar köşesi Ribbed corner</p>				M 12.5x12.5 cm 119x119x23 mm				
Sırsız, Unglazed.		K764610E	C 			4		2.40
 <p>244 23 119</p> <p>Havuz kenarı sol çift kenar yuvarlak parça Rounded pool edge left corner</p>				M 12.5x25 cm 119x244x23 mm				
RAL 5002	K778562	K778551	C 			8		8.00

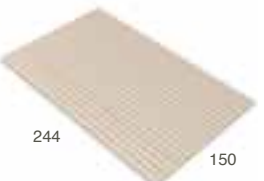

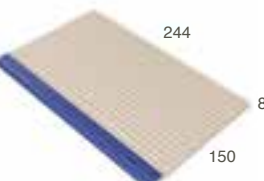



	Parlak Glossy	Mat Matt		Ölçü Dimension	Adet/m Pieces/m	Adet/Kutu Pieces/Box	m²/Kutu m²/Box	kg/Kutu kg/Box
 <p>244 23 119</p>	Havuz kenarı sağ çift kenar yuvarlak parça Rounded pool edge right corner			M 12.5x25 cm 119x244x23 mm				
RAL 5002	K778525	K778514	C 					8.00
 <p>244 23 119</p>	Havuz kenarı kısa kenar yuvarlak parça Rounded pool edge			M 12.5x25 cm 119x244x23 mm				
RAL 5002	K778606	K778595	C 		8	8		8.00
 <p>244 8 119</p>	Tırtıklı havuz kenarı Ribbed tile			M 12.5x25 cm 119x244x8 mm				
RAL 5002 R10B		K880823	R10B		4	28	0,88	13,00
RAL 9016 R10B		K880812	R10B		4	28	0,88	13,00
RAL 2307015 R10B		K880801	R10B		4	28	0,88	13,00
Sırsız. Unglazed.		K781864	C 		4	28	0,88	13,00
 <p>119 8 119</p>	Tırtıklı havuz kenar köşesi Ribbed corner			M 12.5x12.5 cm 119x119x8 mm				
Sırsız. Unglazed.		K786301	C 			4		1.10

Fin Sistemi Üstten Taşmalı - Tırtıklı Parçalar Finnish Overflow System High Water Level - Ribbed Tiles

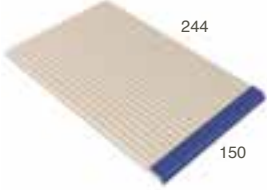
	Parlak Glossy	Mat Matt		Ölçü Dimension	Adet/m Pieces/m	Adet/Kutu Pieces/Box	m²/Kutu m²/Box	kg/Kutu kg/Box
	Havuz kenarı Pool edge			M 12.5x25 cm 119x244x8 mm				
RAL 5002	K785052	K784562	C 		4	20		9.75
RAL 2307015	K791563	K791552	C 		4	20		9.75
	Havuz kenarı iç köşesi Pool edge internal corner			M 12.5x12.5 cm 119x119x8 mm				
RAL 5002	K785074	K785940	C 			4		1.10
RAL 2307015	K791854	K791843	C 			4		1.10
	Havuz kenarı dış köşesi Pool edge external corner			M 12.5x12.5 cm 119x119x8 mm				
RAL 5002	K785085	K785951	C 			4		1.10
RAL 2307015	K791585	K791574	C 			4		1.10
	Havuz kenarı sağ çift kenar yuvarlak parça Rounded pool edge right corner			M 12.5x25 cm 119x244x8 mm				
RAL 5002	K829271	K829260	C 			20		12.00
RAL 2307015	K829293	K829282	C 			20		12.00

	Parlak Glossy	Mat Matt		Ölçü Dimension	Adet/m Pieces/m	Adet/Kutu Pieces/Box	m²/Kutu m²/Box	kg/Kutu kg/Box
	Havuz kenarı sol çift kenar yuvarlak parça Rounded pool edge left corner			M 12.5x25 cm 119x244x8 mm				
RAL 5002	K829315	K829304	C 			20		12.00
RAL 2307015	K829330	K829326	C 			20		12.00
	Havuz kenarı kısa kenar yuvarlak parça Rounded pool edge			M 12.5x25 cm 119x244x8 mm				
RAL 5002	K829352	K829341	C 		8	20		12.00
RAL 2307015	K829374	K829363	C 		8	20		12.00
	Tırtıklı havuz kenarı Unglazed ribbed tile			M 15.6x25 cm 150x244x8 mm				
Sırsız. Unglazed.		K829562	C 		4	25	1	14.50
	Havuz kenarı Pool edge			M 15.6x25 cm 150x244x8 mm				
RAL 5002	K829691	K829680	C 		4	20		11.60
RAL 2307015	K829713	K829702	C 		4	20		11.60
Sırsız. Unglazed.		K829584	C 		4	20		11.60

Fin Sistemi Üstten Taşmalı - Tırtıklı Parçalar Finnish Overflow System High Water Level - Ribbed Tiles

	Parlak Glossy	Mat Matt		Ölçü Dimension	Adet/m Pieces/m	Adet/Kutu Pieces/Box	m²/Kutu m²/Box	kg/Kutu kg/Box
 <p>8</p> <p>244</p> <p>150</p> <p>Havuz kenarı kısa kenar yuvarlak parça Rounded pool edge</p>				M 15.6x25 cm 150x244x8 mm				
RAL 5002	K829610	K829595	C 		6,4	20		11.60
RAL 2307015	K829621	K829606	C 		6,4	20		11.60
Sırsız. Unglazed.		K829573	C 		6,4	20		11.60
 <p>56</p> <p>244</p> <p>8</p> <p>Emniyet şeridi Safety tile</p>				6.2x25 cm 56x244x8 mm				
RAL 5002 R10B		K881442	R10B		4	64		13.20
RAL 0001500 R10B		K881453	R10B		4	64		13.20
 <p>244</p> <p>119</p> <p>7</p> <p>Tırtıklı parça Pinhead tile</p>				M 12.5x25 cm 119x244x7 mm				
RAL 5002	K769532	K769543			4	32	1	14.30
RAL 9016	K769554	K769565			4	32	1	14.30
RAL 2307015	K769510	K769521			4	32	1	14.30
RAL 5002		K862321	R10B		4	32	1	14.30
RAL 9016		K862310	R10B		4	32	1	14.30
RAL 2307015		K862332	R10B		4	32	1	14.30
Sırsız. Unglazed.		K770033	C 		4	32	1	13.25



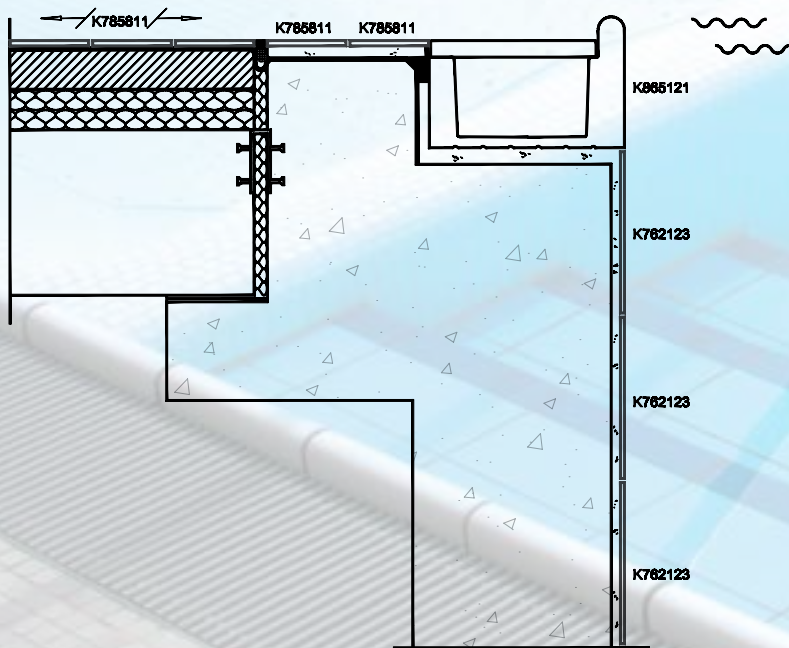
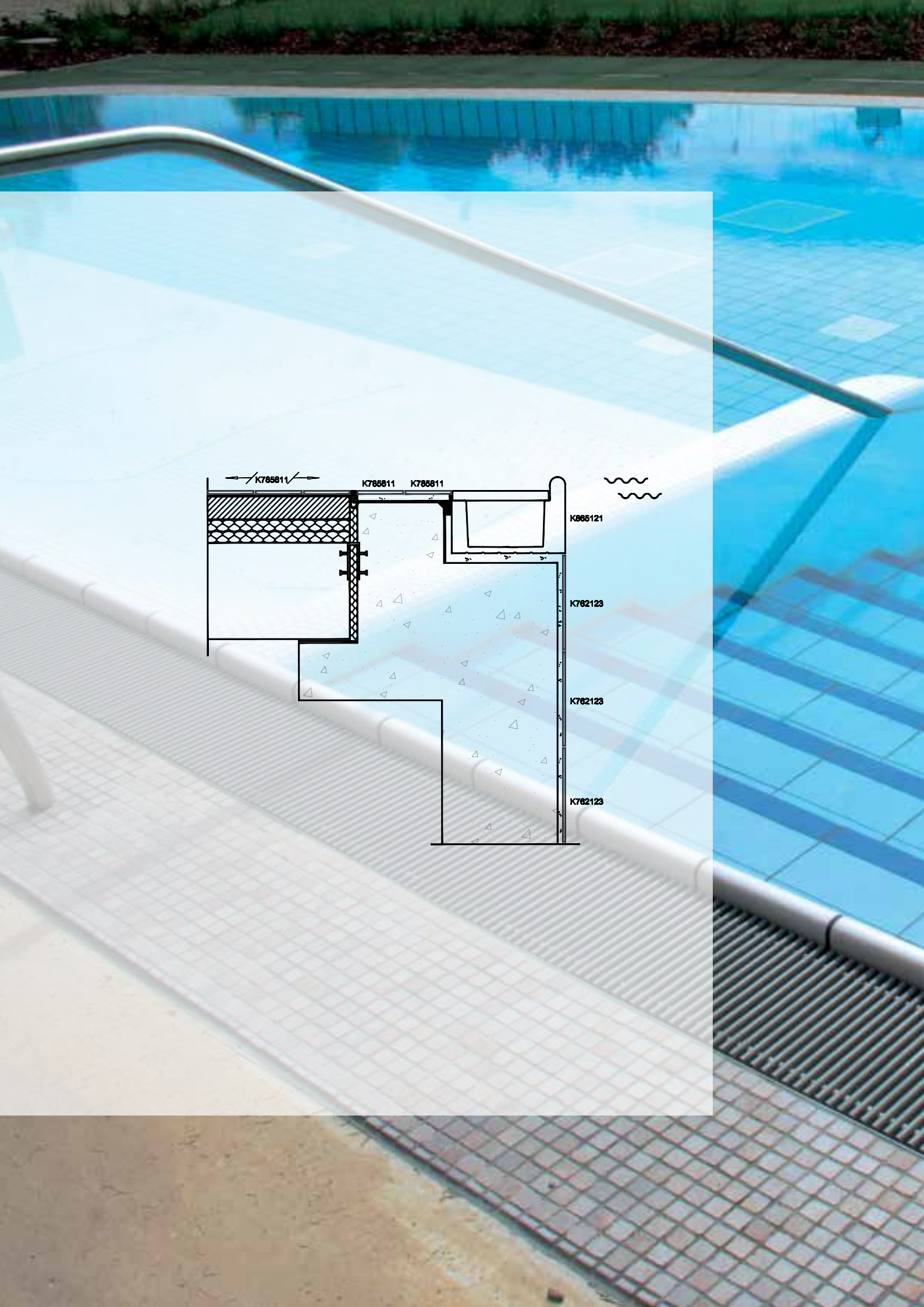



PRO POOL
SOLUTIONS

WIESBADEN SİSTEMİ SYSTEM WIESBADEN

ÜSTTEN TAŞMALI - GENİŞ KANAL
HIGH WATER LEVEL OVERFLOW - WIDE CHANNEL



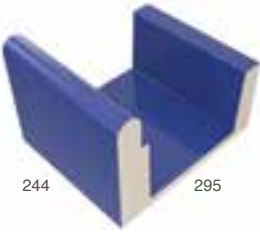
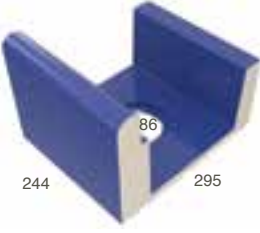
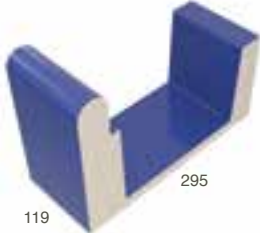
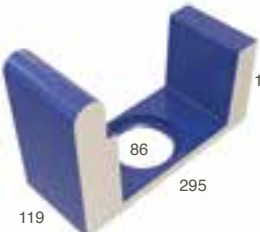

Wiesbaden Sistemi Üstten Taşmalı - Geniş Kanal System Wiesbaden High Water Level Overflow - Wide Channel

	Parlak Glossy	Mat Matt		Ölçü Dimension	Adet/m Pieces/m	Adet/Kutu Pieces/Box	m ² /Kutu m ² /Box	kg/Kutu kg/Box
 <p>200 244 295 140</p> <p>Geniş kanal Wide channel</p>				295x244x200 140 mm				
RAL 5002	K865110				4	1		7.20
RAL 9016	K865106				4	1		7.20
RAL 2307015	K865121				4	1		7.20
 <p>200 244 295 140</p> <p>Delikli geniş kanal Wide channel with outlet</p>				295x244x200 140 mm Ø86				
RAL 5002	K865143				4	1		6.90
RAL 9016	K865132				4	1		6.90
RAL 2307015	K865154				4	1		6.90
 <p>200 119 295 140</p> <p>Yarım geniş kanal Half wide channel</p>				295x119x200 140 mm				
RAL 5002	K865176				8	2		7.20
RAL 9016	K865165				8	2		7.20
RAL 2307015	K865180				8	2		7.20
 <p>200 119 295 140</p> <p>Delikli yarım geniş kanal Half wide channel with outlet</p>				295x119x200 140 mm Ø86				
RAL 5002	K865202				8	2		6.60
RAL 9016	K865191				8	2		6.60
RAL 2307015	K865213				8	2		6.60

	Parlak Glossy	Mat Matt	!	Ölçü Dimension	Adet/m Pieces/m	Adet/Kutu Pieces/Box	m ² /Kutu m ² /Box	kg/Kutu kg/Box
								
	Çeyrek geniş kanal Quarter wide channel			295x56.5x200 140 mm				
RAL 5002	K865235				16	3		6.00
RAL 9016	K865224				16	3		6.00
RAL 2307015	K865246				16	3		6.00
								
	Geniş kanal iç köşesi Wide channel internal corner			295x295x200 140 mm				
RAL 5002	K865261					1		7.20
RAL 9016	K865250					1		7.20
RAL 2307015	K865272					1		7.20
								
	Geniş kanal dış köşesi Wide channel external corner			295x295x200 140 mm				
RAL 5002	K865294					1		9.00
RAL 9016	K865283					1		9.00
RAL 2307015	K865305					1		9.00
								
	Geniş kapak (sağ/sol) Wide end piece (right/left)			Geniş kanala uyumludur Compatible with wide channel				
RAL 5002	K865320					1		0.50
RAL 9016	K865316					1		0.50
RAL 2307015	K865331					1		0.50

Wiesbaden Sistemi Üstten Taşmalı - Geniş Kanal System Wiesbaden High Water Level Overflow - Wide Channel

	Parlak Glossy	Mat Matt	!	Ölçü Dimension	Adet/m Pieces/m	Adet/Kutu Pieces/Box	m ² /Kutu m ² /Box	kg/Kutu kg/Box
 <p>105 244 295 150</p> <p>Geniş kanal Wide channel</p>				295x244x150 105 mm				
RAL 5002	K804246				4	1		5.60
RAL 9016	K804250				4	1		5.60
RAL 2307015	K813020				4	1		5.60
 <p>105 244 295 150</p> <p>Delikli geniş kanal Wide channel with outlet</p>				295x244x150/105 Ø 86 mm				
RAL 5002	K813790				4	1		5.40
RAL 9016	K813812				4	1		5.40
RAL 2307015	K813801				4	1		5.40
 <p>105 119 295 150</p> <p>Yarım geniş kanal Half wide channel</p>				295x119x150 105 mm				
RAL 5002	K828792				8	2		5.60
RAL 9016	K828781				8	2		5.60
RAL 2307015	K828803				8	2		5.60
 <p>105 119 295 150</p> <p>Delikli yarım geniş kanal Half wide channel with outlet</p>				295x119x150/105 Ø 86 mm				
RAL 5002	K828825				8	2		5.60
RAL 9016	K828814				8	2		5.60
RAL 2307015	K828836				8	2		5.60

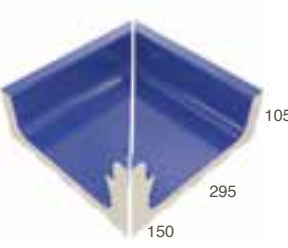
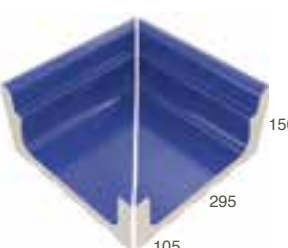
	Parlak Glossy	Mat Matt	! 	Ölçü Dimension	Adet/m Pieces/m	Adet/Kutu Pieces/Box	m ² /Kutu m ² /Box	kg/Kutu kg/Box
 <p>105 295 56.5 150</p> <p>Çeyrek geniş kanal Quarter wide channel</p>				295x56.5x150 105 mm				
RAL 5002	K830730				16	4		5.60
RAL 9016	K830726				16	4		5.60
RAL 2307015	K830741				16	4		5.60
 <p>105 295 150</p> <p>Geniş kanal iç köşesi Wide channel internal corner</p>				295x295x150 105 mm				
RAL 5002	K828884					1		5.00
RAL 9016	K828873					1		5.00
RAL 2307015	K828895					1		5.00
 <p>150 295 105</p> <p>Geniş kanal dış köşesi Wide channel external corner</p>				295x295x150 105 mm				
RAL 5002	K828910					1		6.00
RAL 9016	K828906					1		6.00
RAL 2307015	K828921					1		6.00
 <p>Geniş kapak (sağ/sol) Wide end piece (right/left)</p> <p>Geniş kanala uyumludur Compatible with wide channel</p>								
RAL 5002	K828851					1		0.50
RAL 9016	K828840					1		0.50
RAL 2307015	K828862					1		0.50



Mardan Palace, Antalya, TURKEY



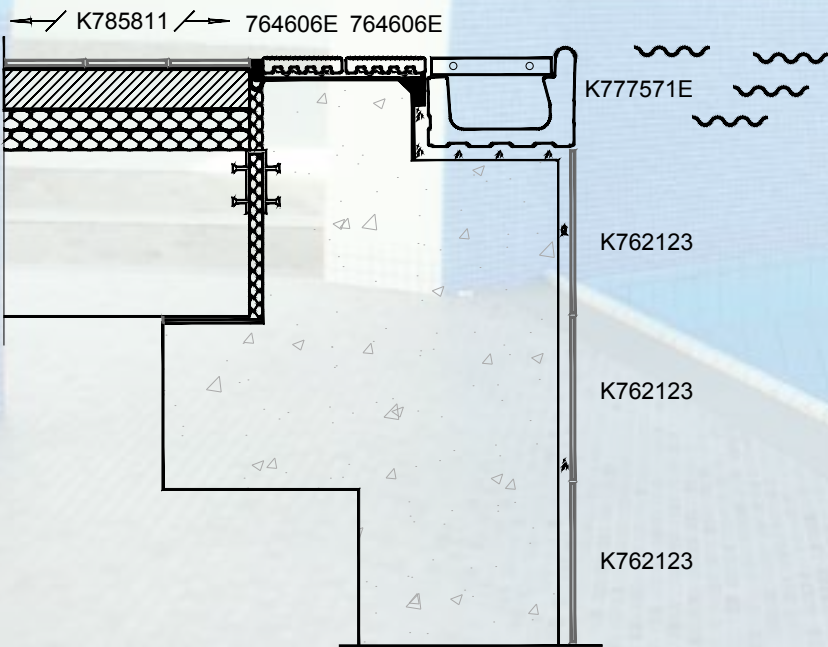



PRO POOL
SOLUTIONS

WIESBADEN SİSTEMİ SYSTEM WIESBADEN

ÜSTTEN TAŞMALI - DAR KANAL
HIGH WATER LEVEL OVERFLOW - NARROW CHANNEL

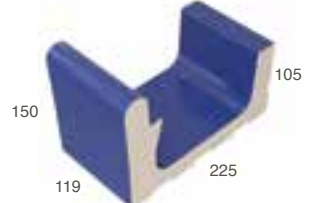
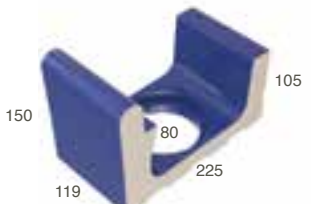

Wiesbaden Sistemi Üstten Taşmalı - Dar Kanal System Wiesbaden High Water Level Overflow - Narrow Channel

	Parlak Glossy	Mat Matt	!	Ölçü Dimension	Adet/m Pieces/m	Adet/Kutu Pieces/Box	m ² /Kutu m ² /Box	kg/Kutu kg/Box
 <p>150 244 105 225</p> <p>Dar kanal Narrow channel</p>				225x244x150 105 mm				
RAL 5002	K777556E				4	1		7.35
RAL 9016	K777534E				4	1		7.35
RAL 2307015	K777571E				4	1		7.35
 <p>105 244 105 225 80</p> <p>Delikli dar kanal Narrow channel with outlet</p>				225x244x150 105 mm Ø 80				
RAL 5002	K777615E				4	1		7.25
RAL 9016	K777593E				4	1		7.25
RAL 2307015	K777630E				4	1		7.25
 <p>150 119 105 225</p> <p>Yarım dar kanal Half narrow channel</p>				225x119x150 105 mm				
RAL 5002	K813403E				8	2		7.40
RAL 9016	K813425E				8	2		7.40
RAL 2307015	K813414E				8	2		7.40
 <p>150 119 105 225 80</p> <p>Delikli yarım dar kanal Half narrow channel with outlet</p>				225x119x150 105 mm Ø 80				
RAL 5002	K828976E				8	2		7.00
RAL 9016	K828965E				8	2		7.00
RAL 2307015	K828980E				8	2		7.00

	Parlak Glossy	Mat Matt		Ölçü Dimension	Adet/m Pieces/m	Adet/Kutu Pieces/Box	m²/Kutu m²/Box	kg/Kutu kg/Box
 <p>150 225 56.5</p>								
	Çeyrek dar kanal Quarter narrow channel			225x56.5x150 105 mm				
RAL 5002	K828943E				16	4		5.25
RAL 9016	K828932E				16	4		5.25
RAL 2307015	K828954E				16	4		5.25
 <p>225 150 105</p>								
	Dar kanal iç köşesi Narrow channel internal corner			225x225x150 105 mm				
RAL 5002	K777674E					1		6.60
RAL 9016	K777652E					1		6.60
RAL 2307015	K777696E					1		6.60
 <p>150 225 105</p>								
	Dar kanal dış köşesi Narrow channel external corner			225x225x150 105 mm				
RAL 5002	K813311E					1		7.00
RAL 9016	K813333E					1		7.00
RAL 2307015	K795483E					1		7.00
								
	Dar kapak (sağ/sol) Narrow end piece (right/left)			Dar kanala uyumludur Compatible with narrow channel				
RAL 5002	K829002					1		0.25
RAL 9016	K828991					1		0.25
RAL 2307015	K829013					1		0.25



Gordon Pool, Tel Aviv, ISRAEL



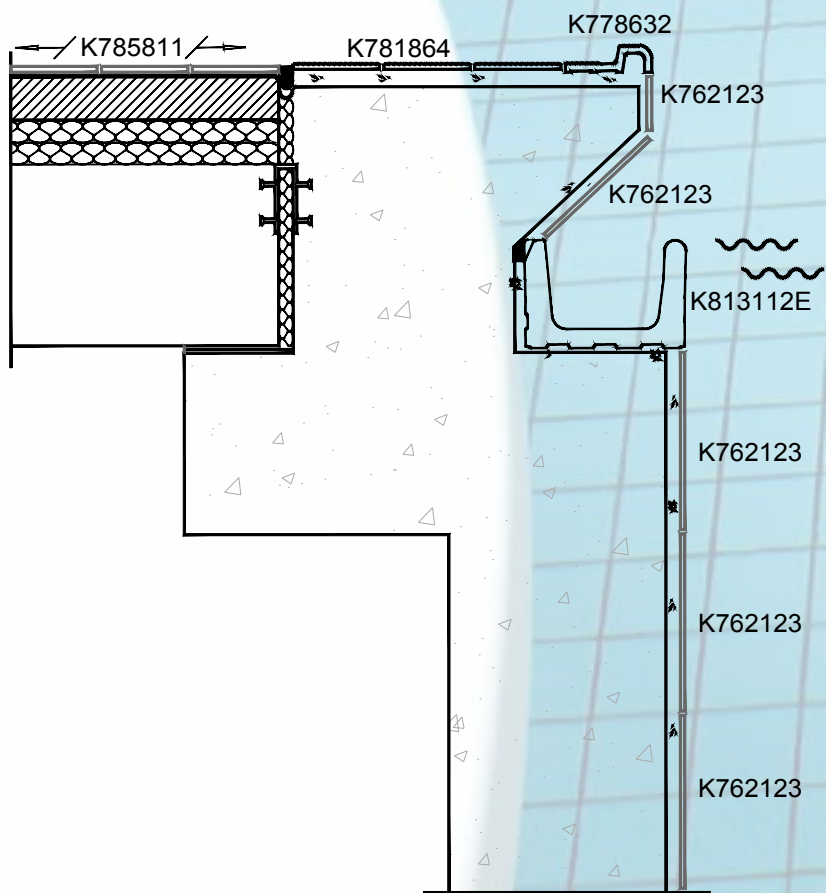





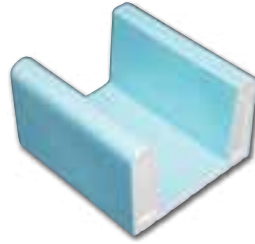

PRO POOL
SOLUTIONS

WIESBADEN SİSTEMİ SYSTEM WIESBADEN

İÇTEN TAŞMALI - IZGARASIZ GENİŞ KANAL
LOW WATER LEVEL OVERFLOW - WIDE CHANNEL
WITHOUT GRATE

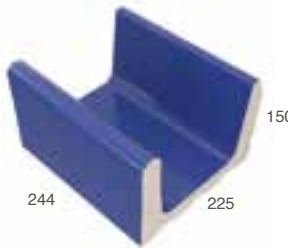
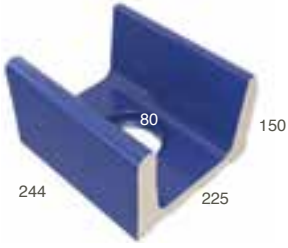

Wiesbaden Sistemi İçten Taşmalı - Izgarasız Geniş Kanal
System Wiesbaden Low Water Level Overflow - Wide Channel Without Grate

	Parlak Glossy	Mat Matt		Ölçü Dimension	Adet/m Pieces/m	Adet/Kutu Pieces/Box	m²/Kutu m²/Box	kg/Kutu kg/Box
 <p>150 244 225</p> <p>Geniş kanal Wide channel</p>				225x244x150 150 mm				
RAL 5002	K813101E				4	1		8.00
RAL 9016	K813123E				4	1		8.00
RAL 2307015	K813112E				4	1		8.00
 <p>150 244 225 80</p> <p>Delikli geniş kanal Wide channel with outlet</p>				225x244x150 150 mm Ø 80				
RAL 5002	K813160E				4	1		7.90
RAL 9016	K813182E				4	1		7.90
RAL 2307015	K813171E				4	1		7.90
 <p>150 119 225</p> <p>Yarım geniş kanal Half wide channel</p>				225x119x150 150 mm				
RAL 5002	K829035E				8	2		8.00
RAL 9016	K829024E				8	2		8.00
RAL 2307015	K829046E				8	2		8.00
 <p>150 119 225 80</p> <p>Delikli yarım geniş kanal Half wide channel with outlet</p>				225x119x150 150 mm Ø 80				
RAL 5002	K829094E				8	2		7.80
RAL 9016	K829083E				8	2		7.80
RAL 2307015	K829105E				8	2		7.80

	Parlak Glossy	Mat Matt		Ölçü Dimension	Adet/m Pieces/m	Adet/Kutu Pieces/Box	m ² /Kutu m ² /Box	kg/Kutu kg/Box
 <p>150 225 56.5</p>								
	Çeyrek geniş kanal Quarter wide channel			225x56.5x150 150 mm				
RAL 5002	K829061E				16	4		5.70
RAL 9016	K829050E				16	4		5.70
RAL 2307015	K829072E				16	4		5.70
 <p>150 150 225</p>								
	Geniş kanal iç köşesi Wide channel internal corner			225x225x150 150 mm				
RAL 5002	K813252E					1		7.35
RAL 9016	K813274E					1		7.35
RAL 2307015	K813263E					1		7.35
 <p>150 150 225</p>								
	Geniş kanal dış köşesi Wide channel external corner			225x225x150 150 mm				
RAL 5002	K813193E					1		7.35
RAL 9016	K813215E					1		7.35
RAL 2307015	K813204E					1		7.35
								
	Geniş kapak (sağ/sol) Wide end piece (right/left)			Geniş kanala uyumludur Compatible with wide channel				
RAL 5002	K829120					1		0.40
RAL 9016	K829116					1		0.40
RAL 2307015	K829131					1		0.40



Kombibad Ossendorf, GERMANY



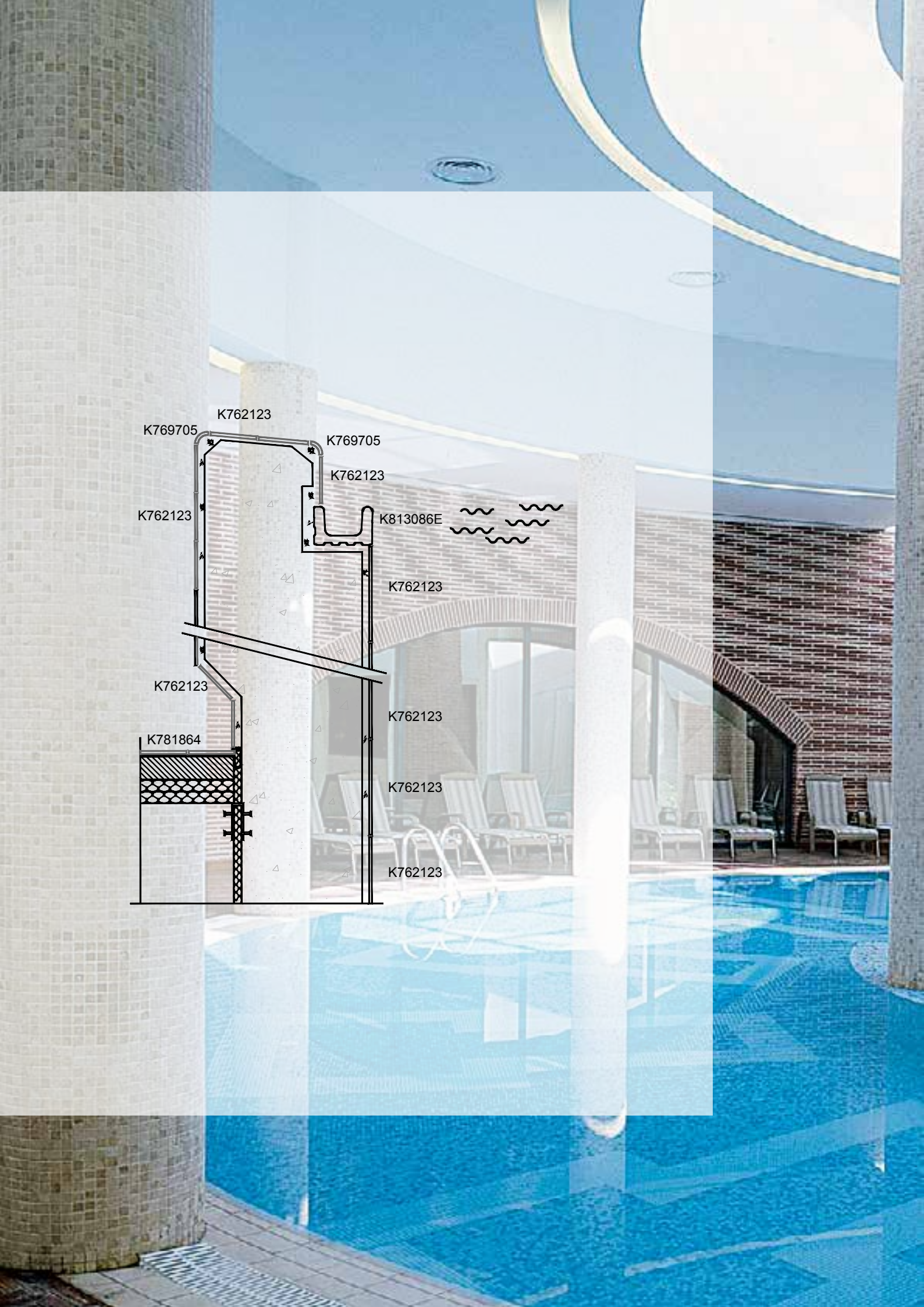
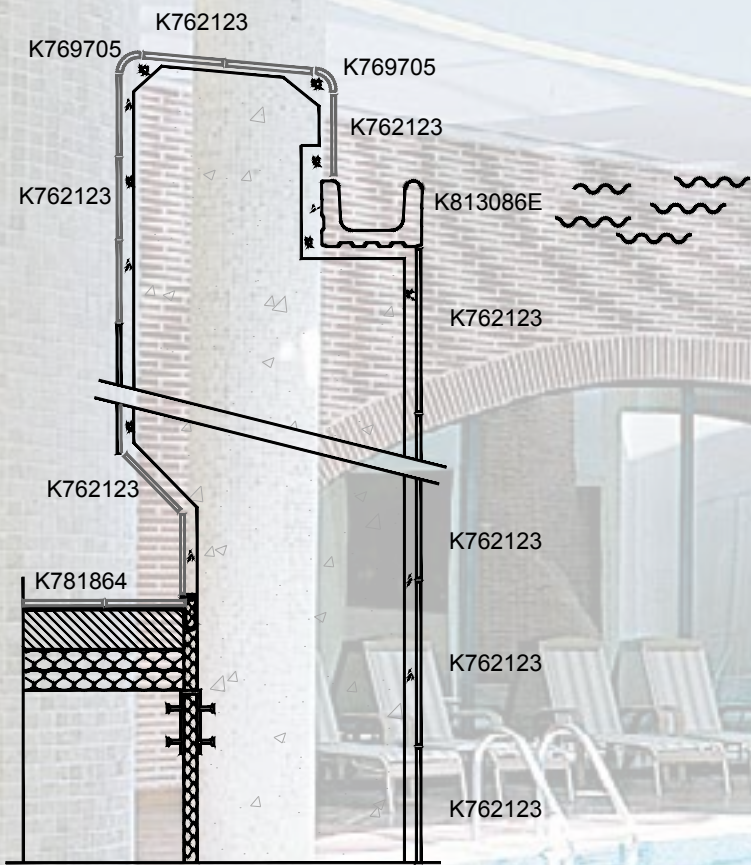



PRO POOL
SOLUTIONS

WIESBADEN SİSTEMİ SYSTEM WIESBADEN

İÇTEN TAŞMALI - IZGARASIZ DAR KANAL
LOW WATER LEVEL OVERFLOW - NARROW CHANNEL
WITHOUT GRATE

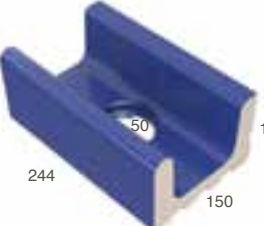
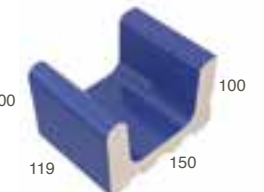
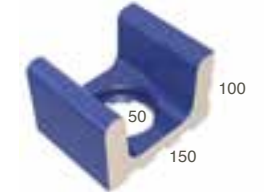

Wiesbaden Sistemi İçten Taşmalı - Izgarasız Dar Kanal
System Wiesbaden Low Water Level Overflow - Narrow Channel Without Grate

	Parlak Glossy	Mat Matt		Ölçü Dimension	Adet/m Pieces/m	Adet/Kutu Pieces/Box	m²/Kutu m²/Box	kg/Kutu kg/Box
 <p>100 244 150</p> <p>Dar kanal Narrow channel</p>				150x244x100 100 mm				
RAL 5002	K813075E				4	2		6.40
RAL 9016	K813090E				4	2		6.40
RAL 2307015	K813086E				4	2		6.40
 <p>100 244 150</p> <p>Delikli dar kanal Narrow channel with outlet</p>				150x244x100 100 mm Ø 50				
RAL 5002	K813134E				4	2		6.20
RAL 9016	K813156E				4	2		6.20
RAL 2307015	K813145E				4	2		6.20
 <p>100 119 150</p> <p>Yarım dar kanal Half narrow channel</p>				150x119x100 100 mm				
RAL 5002	K829153E				8	2		3.20
RAL 9016	K829142E				8	2		3.20
RAL 2307015	K829164E				8	2		3.20
 <p>100 119 150</p> <p>Delikli yarım dar kanal Half narrow channel with outlet</p>				150x119x100 100 mm Ø 50				
RAL 5002	K829212E				8	2		3.10
RAL 9016	K829201E				8	2		3.10
RAL 2307015	K829223E				8	2		3.10



Dag Hazahal Ramat Gan, ISRAEL



0.8m

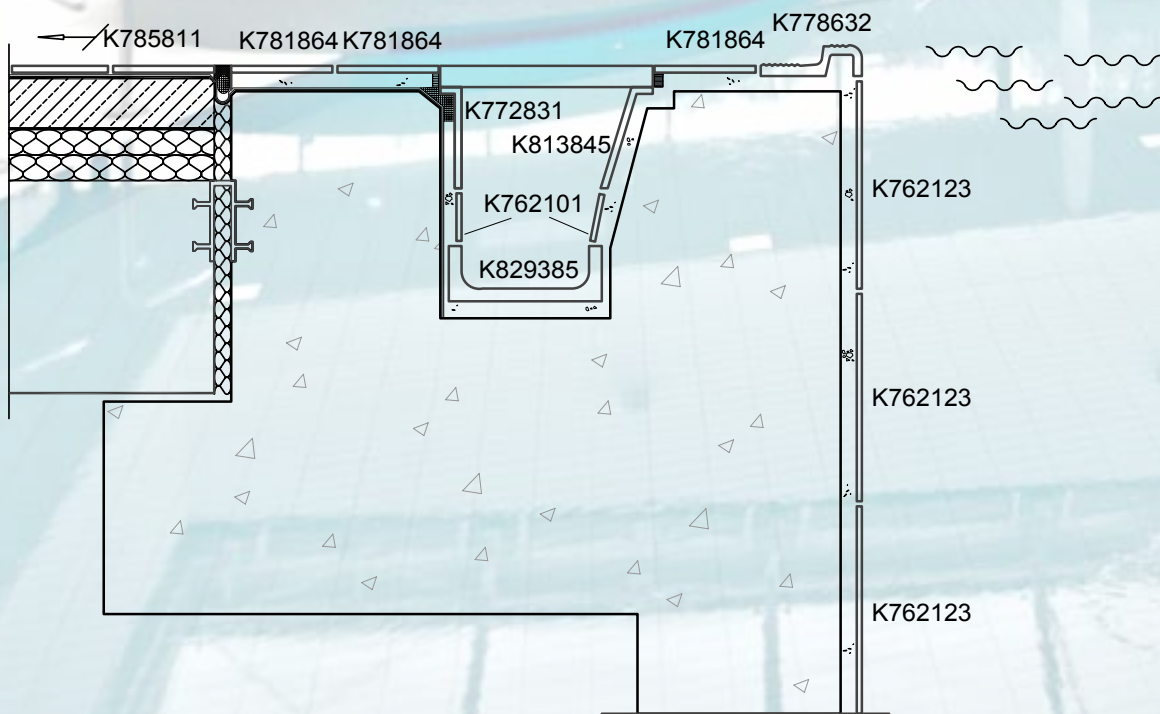
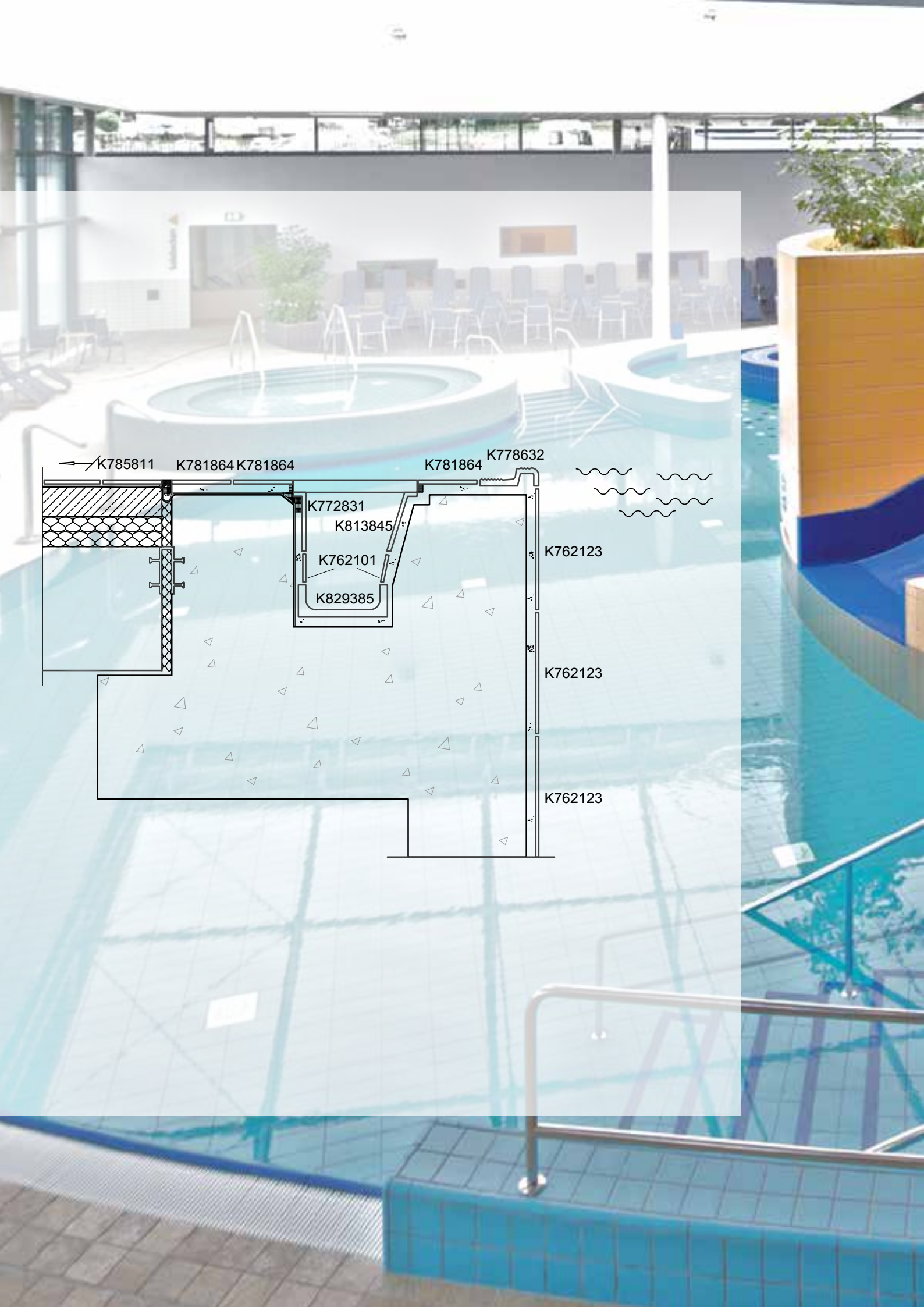







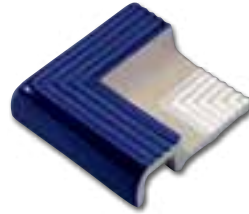

PRO POOL
SOLUTIONS

ZÜRİH SİSTEMİ
SYSTEM ZURICH

ÜSTTEN TAŞMALI
HIGH WATER LEVEL OVERFLOW



Zürih Sistemi Üstten Taşmalı System Zurich High Water Level Overflow

	Parlak Glossy	Mat Matt	Ölçü Dimension	Adet/m Pieces/m	Adet/Kutu Pieces/Box	m ² /Kutu m ² /Box	kg/Kutu kg/Box
	Setli tutamak Pool edge		M 12.5x25 cm 119x244x13/35 mm				
RAL 5002	K778643E	K778632E	C 	4	7		7.10
	Setli tutamak iç köşesi Pool edge internal corner		M 12.5x12.5 cm 119x119x13/35 mm				
RAL 5002	K778680E	K778676E	C 		4		1.70
	Setli tutamak dış köşesi Pool edge external corner		M 12.5x12.5 cm 119x119x13/35 mm				
RAL 5002	K778724E	K778713E	C 		2		1.00



Gordon Pool, Tel Aviv, ISRAEL

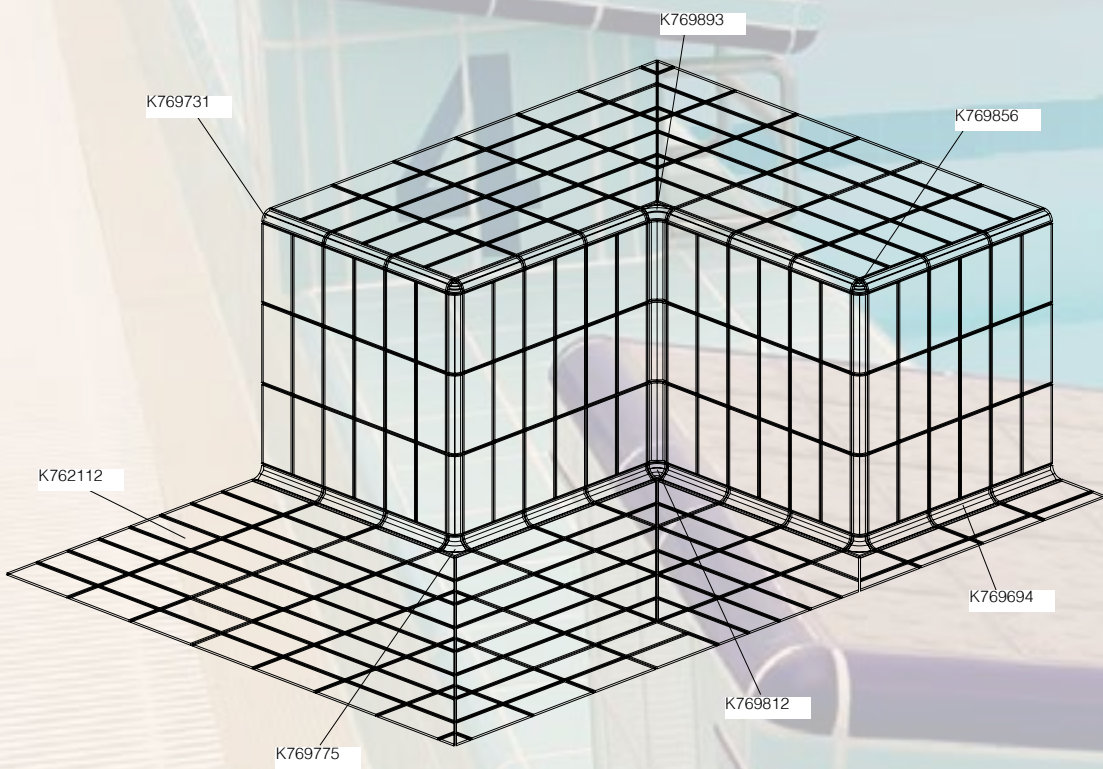



PRO POOL
SOLUTIONS

ÖZEL PARÇALAR SPECIAL MOULDED TRIMS











	Parlak Glossy	Mat Matt	! 	Ölçü Dimension	Adet/m Pieces/m	Adet/Kutu Pieces/Box	m²/Kutu m²/Box	kg/Kutu kg/Box
								
	Alt dış köşe parçası Down-out external corner			40x55xr33 mm				
RAL 5002	K769764	K769775				10		0.94
RAL 2307015	K769742	K769753				10		0.94
RAL 9016	K768042	K775120				10		0.94
								
	Alt dik dış köşe parçası Right-angled down-in external corner			M 5.5x5.5 cm 55x55xr33 mm				
RAL 5002	K880392	K880381				10		0.50
RAL 2307015	K880414	K880403				10		0.50
RAL 9016	K880436	K880425				10		0.50
								
	Üst dış köşe parçası Up-out external corner			40x40xr33 mm				
RAL 5002	K769845	K769856				10		0.25
RAL 2307015	K769823	K769834				10		0.25
RAL 9016	K779166	K785785				10		0.25
								
	Üst iç köşe parçası Up-in internal corner			60x55xr33 mm				
RAL 5002	K769882	K769893				10		0.80
RAL 2307015	K769860	K769871				10		0.80
RAL 9016	K785796	K785800				10		0.80

Özel Parçalar
Special Moulded Trims

	Parlak Glossy	Mat Matt	!	Ölçü Dimension	Adet/m Pieces/m	Adet/Kutu Pieces/Box	m ² /Kutu m ² /Box	kg/Kutu kg/Box
 <p>55 155</p>	Sağ dönüş profili Right corner for internal beading			55x155xr33 mm		10		2.30
RAL 9016	K768064							
 <p>155 55</p>	Sol dönüş profili Left corner for internal beading			55x155xr33 mm		10		2.30
RAL 9016	K768075							
 <p>244 80</p>	Dış profil External beading			M 8x25 cm 80x244xr60 mm				
RAL 5002		K880440			4	10		5.20
RAL 9016		K880484			4	10		5.20
 <p>80 70</p>	Üst iç köşe parçası Up-in internal corner			M 7x8 cm 70x80xr60 mm				
RAL 5002		K880506				4		2.30
RAL 9016		K880543				4		2.30





	Parlak Glossy	Mat Matt		Ölçü Dimension	Adet/m Pieces/m	Adet/Kutu Pieces/Box	m²/Kutu m²/Box	kg/Kutu kg/Box
								
	Üst dış köşe parçası Up-out external corner			M 8x8 cm 80x80xr60 mm				
RAL 5002		K880565				4	0.60	
RAL 9016		K880602				4	0.60	
								
	İç profil Internal beading			M 7x25 cm 70x244xr60 mm				
RAL 5002		K880624				4	10	4.90
RAL 9016		K880661				4	10	4.90
								
	Alt iç köşe parçası Down-in internal corner			M 7x7 cm 70x70xr60 mm				
RAL 5002		K880683				4	0.60	
RAL 9016		K880720				4	0.60	
								
	Alt dış köşe parçası Down-out external corner			M 8x7 cm 80x70xr60 mm				
RAL 5002		K880742				4	1.50	
RAL 9016		K880786				4	1.50	



Özel Parçalar
Special Moulded Trims

	Parlak Glossy	Mat Matt		Ölçü Dimension	Adet/m Pieces/m	Adet/Kutu Pieces/Box	m ² /Kutu m ² /Box	kg/Kutu kg/Box
 <p>244 23 119</p> <p>Kanal parçası Channel tile</p>				M 12.5x25 cm 119x244x23 mm				
Sırsız. Unglazed.		K769941	B 		4	8		7.20
 <p>244 23 119</p> <p>Kanal bitiş parçası Channel stopper</p>				M 12.5x25 cm 119x244x23 mm				
Sırsız. Unglazed.		K769963	B 			8		7.20
 <p>244 23 119 52</p> <p>Delikli kanal parçası Channel tile with outlet</p>				M 12.5x25 cm 119x244x23 mm Ø 80				
Sırsız. Unglazed.		K769952	B 		4	8		6.70
 <p>115 23 115</p> <p>Kanal parçası iç köşesi Channel internal corner</p>				M 12.5x12.5 cm 119x119x23 mm				
Sırsız. Unglazed.		K772536	B 			4		1.75

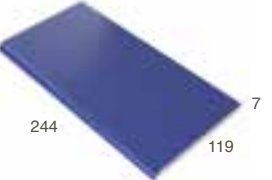
	Parlak Glossy	Mat Matt	! 	Ölçü Dimension	Adet/m Pieces/m	Adet/Kutu Pieces/Box	m ² /Kutu m ² /Box	kg/Kutu kg/Box
 <p>244 23 119</p> <p>Derinlik işareti Depth marker</p>				M 12.5x25 cm 119x244x23 mm				
RAL 5002	K772595	K772584			4	8		7.70
 <p>244 23 119</p> <p>Yön işareti I Direction mark I</p>				M 12.5x25 cm 119x244x23 mm				
RAL 5002	K778923	K778912			4	8		8.00
 <p>244 23 119</p> <p>Yön işareti II Direction mark II</p>				M 12.5x25 cm 119x244x23 mm				
RAL 5002	K778960	K778956			4	8		8.00

Özel Parçalar
Special Moulded Trims

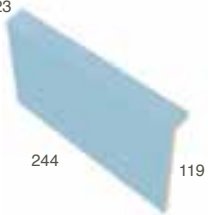
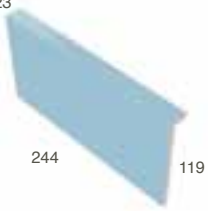
	Parlak Glossy	Mat Matt		Ölçü Dimension	Adet/m Pieces/m	Adet/Kutu Pieces/Box	m²/Kutu m²/Box	kg/Kutu kg/Box
								
	K770280	K769150		M 12.5x25 cm 119x244x7 mm	8	25		11.40
	K770243	K769076			8	25		11.40
	K770265	K769113			8	25		11.40
		K862111	R10B		8	25		11.40
		K862122	R10B		8	25		11.40
		K862133	R10B		8	25		11.40
								
	K770291	K769146		M 12.5x25 cm 119x244x7 mm	4	25		11.40
	K770254	K769065			4	25		11.40
	K770276	K769102			4	25		11.40
		K862166	R10B		4	25		11.40
		K862170	R10B		4	25		11.40
		K862181	R10B		4	25		11.40
								
	K770210	K769135		M 12.5x25 cm 119x244x7 mm		25		11.40
	K770173	K769054				25		11.40
	K770195					25		11.40
		K769091				25		11.40
		K862214	R10B			25		11.40
		K862225	R10B			25		11.40
		K862236	R10B			25		11.40
								
	K770206	K769124		M 12.5x25 cm 119x244x7 mm		25		11.40
	K770162	K769043				25		11.40
	K770184					25		11.40
		K769080				25		11.40
		K862262	R10B			25		11.40
		K862273	R10B			25		11.40
		K862284	R10B			25		11.40

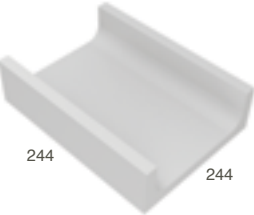
	Parlak Glossy	Mat Matt		Ölçü Dimension	Adet/m Pieces/m	Adet/Kutu Pieces/Box	m ² /Kutu m ² /Box	kg/Kutu kg/Box
 <p>23 244 119</p>	Kanal yan parçası Shank tile			M 12.5x25 cm 119x244x8 mm				
RAL 9016	K772831	K793803			4	12		6.20
RAL 2307015	K769974	K769985			4	12		6.20
 <p>23 244 119</p>	Kanal yan parçası eğimli Shank tile slope			M 12.5x25 cm 119x244x8 mm				
RAL 9016	K813845	K816284			4	12		6.20
RAL 2307015	K813834	K816273			4	12		6.20
 <p>244 22 33</p>	Izgara profili Grid Profil			M 3.3x25 cm 33/22x244x8 mm				
RAL 9016	K831710	K831706			4	12		14.40
 <p>65 244 244</p>	Kanal parçası Channel tile			180x244x65/65 mm				
RAL 9016	K829385				4	2		5.00

Özel Parçalar
Special Moulded Trims

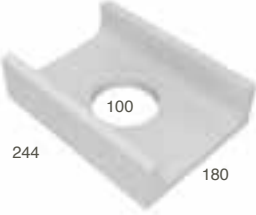
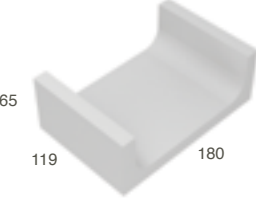
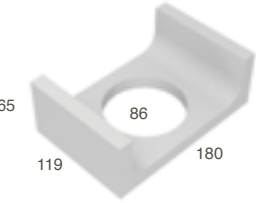
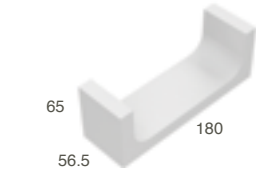
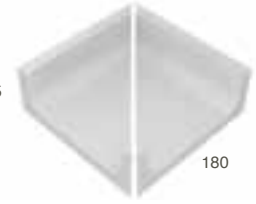
	Parlak Glossy	Mat Matt		Ölçü Dimension	Adet/m Pieces/m	Adet/Kutu Pieces/Box	m ² /Kutu m ² /Box	kg/Kutu kg/Box
 <p>65 244 180 100</p> <p>Delikli kanal parçası Channel tile with outlet</p>				180x244x65/65 Ø100 mm	4	2		5.00
RAL 9016	K829411							
 <p>65 119 180</p> <p>Yarım kanal parçası Half channel tile</p>				180x119x65/65 mm	8	4		5.00
RAL 9016	K829444							
 <p>65 119 180 86</p> <p>Delikli yarım kanal parçası Half channel tile with outlet</p>				180x119x65/65 Ø86 mm	8	4		5.00
RAL 9016	K829470							
 <p>65 56.5 180</p> <p>Çeyrek kanal parçası Quarter channel tile</p>				180x56.5x65/65 mm	16	4		5.00
RAL 9016	K829503							
 <p>65 180</p> <p>Kanal parçası iç-dış köşesi Channel internal-external corner</p>				180x180x65/65 mm		1		150
RAL 9016	K830682							



Lehrschwimmbecken
W.T. 1,35m

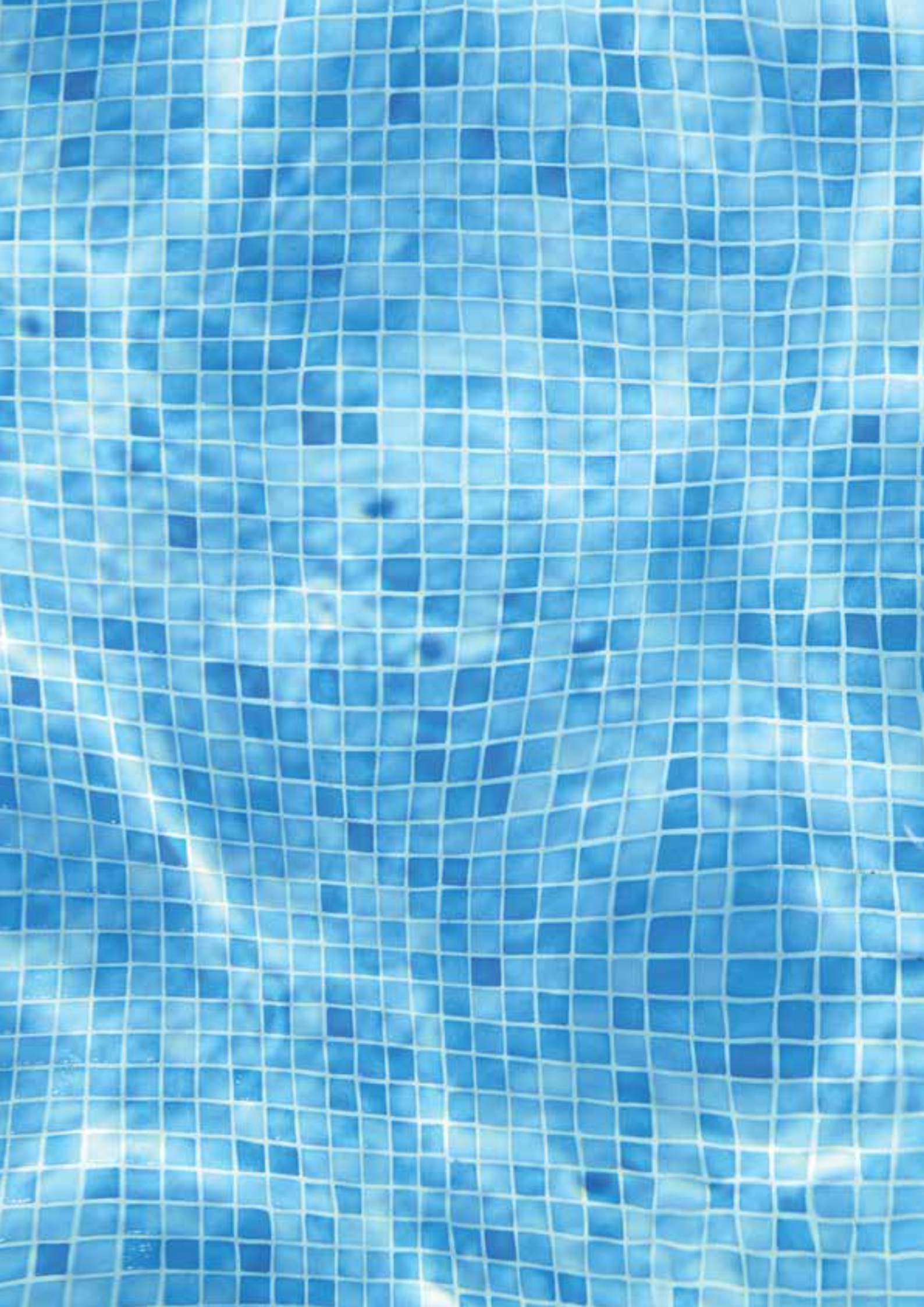

POOL TILES

HAVUZ KAROLARI



PRO

TECHNIC

HİJYENİKTİR, KOLAY TEMİZLENİR, KİMYASALLARA DAYANIKLIDIR

VitrA PRO Technic karolar temizlik kimyasallarına karşı dayanıklıdır. Bu nedenle konutlar, eğitim kurumları, hastaneler ve sık temizlik gerektiren yoğun trafikli mekânlar için hijyen özelliği ile güvenle kullanılabilir.

HYGIENIC, EASY TO CLEAN, RESISTANT TO CHEMICALS

VitrA PRO Technic tiles are resistant to the chemicals. Therefore, they can be used safely thanks to its hygienic feature, in homes, educational establishments, hospitals and high-traffic locations which require frequent cleaning.



PRO

TECHNIC

UZUN ÖMÜRLÜDÜR, RENGİ VE DESENİ SOLMAZ

VitrA PRO Technic karolar güneş ve su gibi dış etkenlerden etkilenmez, renk ve desenlerinde asla solma olmaz. Her türlü zorlu koşulda ilk günkü göz alıcı görünümünü korur.

LONG LASTING, COLORFAST, NON-FADING

VitrA PRO Technic tiles are not affected by the element such as sun and water, they never discolor or fade and maintain its eye catching appearance just like the first day.



PRO

TECHNIC

DIŐ MEKÂNLARDA GÜVENLE KULLANILIR

VitrA PRO Technic karo sağlam ve dayanıklı olma özelliđiyle dış mekânlarda uzun yıllar problemsiz kullanılabilcek bir üründür. Sıcak ve sođuk ısı deđişimlerinden etkilenmez; yağmur, kar ve dona dayanıklıdır. Bahçe ve teras gibi dış mekânlara için idealdir.

SAFELY USED OUTDOOR

VitrA PRO Technic tile is a product which can be used outdoor hassle-free for any years as it's sturdy and durable. It is not affected by hot and cold temperature changes; resistant to rain, snow and frost. Ideal for outdoor spaces such as patios/courts and terraces.



PRO

TECHNIC

FARKLI KAYMAZLIK SINIFINDA ÜRÜNLER SUNAR

VitrA PRO Technic karoların en önemli özelliklerinden biri farklı kaymazlık sınıflarında ürünler sunmasıdır. Kaymazlığın gerekli olduğu, nemin ve ıslak zeminlerin tehlike yarattığı tüm alanlarda, ev ya da profesyonel mekanlarda uzun yıllar güvenle kullanılabilir.

OFFERING PRODUCTS IN DIFFERENT NONSLIP CLASSES

One of the major features of VitrA PRO Technic tiles is that they come in diverse nonslip grades. It can be used safely for many years in all spaces, homes or professional spaces where nonslip feature is required and damp and wet floors pose a danger.



PRO

TECHNIC

TUZ VE KLORDAN ETKİLENMEZ

Tuz ve klor uzun süre temas ettikleri yüzeyleri aşındırır. VitrA PRO Technic karolar tuz ve klordan etkilenmeyen yapısıyla havuz kenarı, süs havuzu, plaj çevresi gibi alanlarda uzun yıllar kullanmak için ideal bir seçimdir.

SALT AND CHLORINE-PROOF

Salt and chlorine wears off the surfaces they get in touch for a long time. VitrA PRO Technic tiles is an ideal choice for use in locations such as pool sides, ponds, beach perimeter, etc. for many years, as they are not affected by salt and chlorine.



COLOR TACTICS

RENK OYUNLARI

Renklerle oynayabileceğiniz, benzersiz alanlar yaratabileceğiniz ve mekanlara hayat katabileceğiniz çeşitlilikte bir renk paleti size hayallerinizi tasarlama özgürlüğü sunuyor.

A wide color palette with which you can play with the colors, create unique structures and vitalise the spaces, offers you the freedom to design your dreams.

RENKLERİN DÜNYASI

VitrA COLOR ÜRÜNLERİNDE, CIELAB RENK ÖLÇÜM METODUNUN TEMEL ALINDIĞI, ULUSLARARASI KABUL EDİLMİŞ RENK STANDARDI OLAN RAL RENK TASARIM SİSTEMİ KULLANILYOR. SAYISIZ RENK SEÇENEĞİNİ İÇİNDE BARINDIRAN VitrA COLOR ÜRÜNLERİYLE İSTENEN ATMOSFER HER TÜRLÜ MEKANDA YARATILABİLİYOR.

WORLD OF COLORS

RAL COLOR DESIGN SYSTEM, BASED ON THE CIELAB COLOR MEASUREMENT METHOD, THE INTERNATIONALLY ACCEPTED COLOR STANDARD, IS USED IN VitrA COLOR PRODUCTS. ANY DESIRED ATMOSPHERE CAN BE CREATED IN ANY SPACE WITH VitrA COLOR PRODUCTS, CONSISTING OF COUNTLESS COLOR OPTIONS.

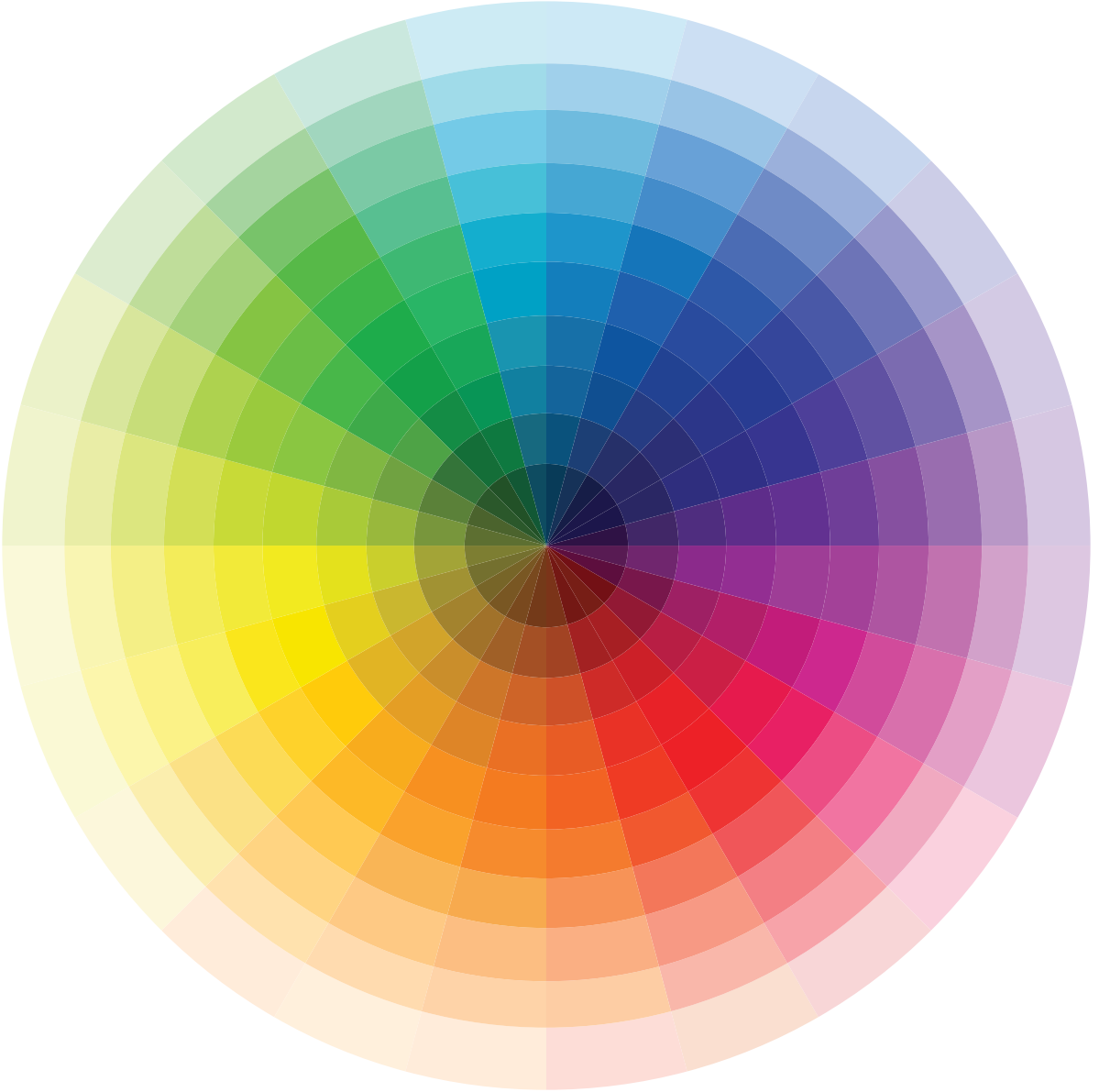

HER MEKANDA MODÜLERLİK

KÜÇÜK BİR EVİN BANYOSU YA DA DEV BİR ALIŞVERİŞ MERKEZİ. COLOR'IN MODÜLER YAPISI FARKLI BÜYÜKLÜKLERDE TASARIMLARIN BİR BÜTÜNLÜK İÇİNDE HAYATA GEÇMESİNİ SAĞLIYOR. 2.5X2.5 CM'DEN 60X60 CM'YE 12 FARKLI BOYUTTA YER VE DUVAR KAROLARI 3 MM'LİK DERZ ARALIKLARINA UYGUN OLARAK ÜRETİLİYOR. COLOR'IN TÜM ÜRÜNLERİNİ SINIRSIZ KOMBİNASYONLARLA KULLANARAK TASARIMLARINIZI GERÇEĞE DÖNÜŞTÜREBİLİRSİNİZ. DUVAR VE İÇ MEKAN KULLANIMINA ÖZEL COLOR WALL SERİSİ 2 MM DERZE GÖRE MODÜLER OLARAK ÜRETİLİYOR. ÜSTELİK 15X15 CM, 20X20 CM EBATLARINA EK OLARAK SADECE DUVAR KULLANIMI İÇİN 15X30 CM SEÇENEĞİ DE MEVCUT.

MODULARITY EVERYWHERE

THE BATHROOM OF A SMALL HOUSE OR A GIGANTIC SHOPPING MALL.THE MODULAR STRUCTURE OF COLOR LETS DESIGNS OF DIFFERENT MAGNITUDES OCCUR IN COHERENCE. 12 DIFFERENT SIZES OF FLOOR AND WALL TILES FROM 2.5X2.5 CM UP TO 60X60 CM ARE PRODUCED IN ACCORDANCE WITH 3 MM JOINT SPACES. YOU CAN REALIZE ALL YOUR DESIGNS BY COMBINING LIMITLESSLY ALL THE COLOR PRODUCTS. COLOR WALL SERIES, SPECIFIC FOR USAGE ON WALLS AND INTERIOR SPACES, ARE PRODUCED MODULARLY TO FIT 2 MM JOINT SPACE. MOREOVER, IN ADDITION TO 15X15 CM AND 20X20 CM SIZES, 15X30 CM SIZE OPTION SPECIFIC FOR WALLS IS ALSO AVAILABLE.



COLOR



BASIC



AQUA



NEUTRAL



MOOD

COLOR

BASIC



RAL 9016



RAL 0001500



RAL 1105050



RAL 1008080



**RAL 0808060
RAL 1018**



RAL 0757070



**RAL 2003
RAL 2010**



**RAL 0304050
RAL 3000**

AQUA



RAL 2008020



RAL 2006020



RAL 2004030



RAL 2307015



RAL 2306020



RAL 2404020



RAL 2606030



RAL 2603035



RAL 5002

NEUTRAL

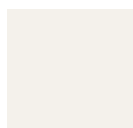

RAL 1009005

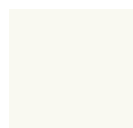

RAL 0809005



RAL 0809010



RAL 0808010



RAL 0958010



RAL 0007500



RAL 0806005



RAL 0505010



RAL 7047



RAL 0008000



RAL 0005500



RAL 0004000

MOOD



RAL 3004



RAL 0504040



RAL 0706040



RAL 2904015



RAL 0404005



RAL 0606020



RAL 0206005



RAL 1007010



RAL 2205005

COLOR

Açıktan Koyuya / Light to Dark



RAL 9016
Beyaz
White

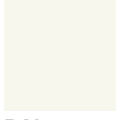

RAL 0809005
Krem
Biscuit

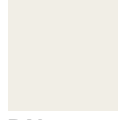

RAL 1009005
Ultra Beyaz
Ultra White



RAL 0809010
Açık Kum Beji
Light Sand



RAL 7047
Açık Gri
Light Grey



RAL 2008020
Cam Göbeği
Calipso



RAL 0808010
Kum Beji
Sand



RAL 0958010
Açık Vizon
Light Mink



RAL 1007010
Açık Haki
Light Khaki



RAL 0008000
Gri
Grey



RAL 0007500
Grej
Greige



RAL 2307015
Havuz Mavisi
Pool Blue



RAL 0005500
Koyu Gri
Dark Grey



RAL 1008080
Limon Yeşili
Lime Green



RAL 0808060
Sarı / Yellow
Mat / Matt
RAL 1018
Parlak / Glossy



RAL 0757070
Koyu Sarı
Dark Yellow



RAL 2006020
Turkuaz
Turquoise



RAL 0806005
Koyu Grej
Dark Greige



RAL 0206005
Leylak
Whisper Lilac



RAL 0606020
Tatlı Kahve
Soft Brown



RAL 2606030
Soğuk Mavi
Cool Blue



RAL 2306020
Mavi
Blue



RAL 1105050
Yeşil
Green



RAL 0706040
Toprak Sarısı
Ochre Yellow



RAL 2003
Turuncu / Orange
Mat / Matt
RAL 2010
Parlak / Glossy



RAL 0505010
Vizon
Mink



RAL 2205005
Prusya Mavisi
Prussian Blue



RAL 2004030
Koyu Turkuaz
Dark Turquoise



RAL 0504040
Taba
Tobacco



RAL 0404005
Basalt Kahve
Basalt Brown



RAL 0004000
Antrasit
Anthracite



RAL 0304050
Kırmızı / Red
Mat / Matt
RAL 3000
Parlak / Glossy



RAL 2404020
Okyanus Mavisi
Ocean Blue



RAL 2603035
Göl Mavisi
Aqua Blue



RAL 5002
Kobalt Mavi
Cobalt Blue



RAL 3004
Bordo
Burgundy



RAL 2904015
Mürdüm
Plum



RAL 0001500
Siyah
Black

RENK GRUPLARI COLOR GROUPS

Sıcak Renkler / Warm Colors

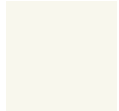

RAL 0809010
Açık Kum Beji
Light Sand

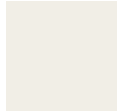

RAL 1009005
Ultra Beyaz
Ultra White

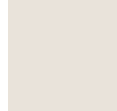

RAL 0809005
Krem
Cream

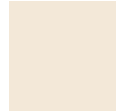

RAL 0809010
Açık Kum Beji
Light Sand



RAL 0808010
Kum Beji
Sand

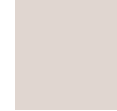

RAL 0958010
Açık Vizon
Light Mink



RAL 1007010
Açık Haki
Light Khaki



RAL 0007500
Grej
Greige



RAL 0606020
Tatlı Kahve
Soft Brown



RAL 0706040
Toprak Sarısı
Ochre Yellow



RAL 1008080
Limon Yeşili
Lime Green
Parlak / Glossy



RAL 0808060
Sarı / Yellow
Mat / Matt
RAL 1018



RAL 0757070
Koyu Sarı
Dark Yellow



RAL 2003
Turuncu / Orange
Mat / Matt
RAL 2010
Parlak / Glossy



RAL 1105050
Yeşil
Green



RAL 0505010
Vizon
Mink



RAL 0504040
Taba
Tobacco



RAL 3004
Bordo
Burgundy
Parlak / Glossy



RAL 0304050
Kırmızı / Red
Mat / Matt
RAL 3000



RAL 0404005
Basalt Kahve
Bazalt Brown

Soğuk Renkler / Cold Colors



RAL 9016
Beyaz
White

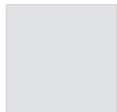

RAL 7047
Açık Gri
Light Grey



RAL 0005500
Koyu Gri
Dark Grey



RAL 0008000
Gri
Grey



RAL 0806005
Koyu Grej
Dark Greige



RAL 0206005
Leylak
Whisper Lilac



RAL 0004000
Antrasit
Anthracite



RAL 2205005
Prusya Mavisi
Prussian Blue



RAL 0001500
Siyah
Black



RAL 2904015
Mürdüm
Plum



RAL 2008020
Cam Göbeği
Calipso



RAL 2307015
Havuz Mavisi
Pool Blue



RAL 2006020
Turkuaz
Turquoise



RAL 2004030
Koyu Turkuaz
Dark Turquoise



RAL 2606030
Soğuk Mavi
Cool Blue



RAL 2306020
Mavi
Blue



RAL 2404020
Okyanus Mavisi
Ocean Blue



RAL 2603035
Göl Mavisi
Aqua Blue



RAL 5002
Kobalt Mavi
Cobalt Blue

AQUA





K542014 10x10 Aqua RAL 2404020
K534476 10x10 Aqua RAL 2306020
K1BB0050028 10x10 Aqua RAL 2307015



COLOR

Porselen Karolar / Porcelain Tiles Seramik Yer Karoları / Ceramic Floor Tiles

Yüzey Alternatifleri / Surface Alternatives

Mat / Matt
Parlak / Glossy
R10A
R10B
C

Porselen ve Seramik Yer Karosu Ebatları / Porcelain and Ceramic Floor Tiles Sizes

M2,5x2,5 cm (23x23x6 mm)
M5x5 cm (47x47x6 mm)
M10x10 cm (97x97x6 mm)
M10x20 cm (97x197x6 mm)
M12,5x25 cm (119x244x6,5 mm)
M10x30 cm (97x297x6 mm)
M15x15 cm (147x147x6 mm)
M20x20 cm (197x197x6 mm)
M30x30 cm (297x297x7 mm)

Fon Renkleri / Basic Tile Colors

Cam Göbeği / Calipso, RAL 2008020
Turkuaz / Turquoise, RAL 2006020
Koyu Turkuaz / Dark Turquoise, RAL 2004030
Havuz Mavisi / Pool Blue, RAL 2307015
Mavi / Blue, RAL 2306020
Okyanus Mavisi / Ocean Blue, RAL 2404020
Soğuk Mavi / Cool Blue, RAL 2606030
Göl Mavisi / Aqua Blue, RAL 2603035
Kobalt Mavi / Cobalt Blue, RAL 5002

Kullanım Alanları / Usage Areas

Konut / Residential
Ticari Alan / Commercial

Döşeme Alanları / Tiling Areas

Yer / Floor
Duvar / Wall

Dona Dayanım / Frost Resistance

Var / Available

Desen Farklılaşması / Shade Variation Classification

V0

Ürün Standardı / Product Standard

EN14411 Group Bla
EN14411 Group Blb

AQUA

SUYUN RAHATLATICI ETKİSİNİ GÜÇLENDİREN VE ÖZELLİKLE HAVUZ YA DA SPA ALANLARI İÇİN TERCİH EDİLEN MAVİ VE TURKUAZIN TONLARINI, RENK GEÇİŞLERİNİ, BEYAZ VE SİYAHIN FARKLI EBAT ALTERNATİFLERİYLE KOMBİNASYONLARINI AQUA'DA BULABİLİRSİNİZ. AQUA SİZE SU İLE MİMARININ BULUŞTUĞU FARKLI MEKANLAR İÇİN HİJYENİK, GÜVENLİ VE ESTETİK BİR KAPLAMA ÇÖZÜMÜ SUNUYOR. SUYUN HAYAT VEREN CANLILIĞINI KARONUN UZUN ÖMÜRLÜ DAYANIKLILIĞIYLA BİRLEŞTİRİYOR.

PROMOTING THE RELAXING EFFECT OF WATER WITH THE USE OF VARIOUS SHADES OF BLUE AND TURQUOISE, COLOR TRANSITIONS AND WHITE AND BLACK, AQUA IS ESPECIALLY IDEAL FOR POOLS AND SPA CENTERS WITH ITS SERIES OF DIFFERENT SIZE OPTIONS. PRO COLOR AQUA OFFERS HYGIENIC, RELIABLE AND AESTHETIC TILING SOLUTIONS FOR MODERN SPACES WHERE WATER MEETS ARCHITECTURE. THE SERIES COMBINES THE VITALITY OF WATER WITH LONG-TERM DURABILITY OF TILES.



Porselen
Porcelain



Yer Karosu
Floor Tile



Duvar Karosu
Wall Tile



Konut
Residential



Havuz Çevresi
Pool Surrounding



Dona Dayanım
Frost Resistance



Mat
Matt



Parlak
Glossy



Rektifiyesiz
Non Rectified



Modülerlik
Modularity



Desen Farklılaşması
Shade Variation

AQUA



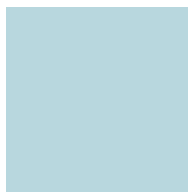

RAL 2307015
Mat / Matt



RAL 2306020
Mat / Matt



RAL 2404020
Mat / Matt

K542014 10x10 Aqua RAL 2404020
K534476 10x10 Aqua RAL 2306020
K1BB0050028 10x10 Aqua RAL 2307015

COLOR

MIX

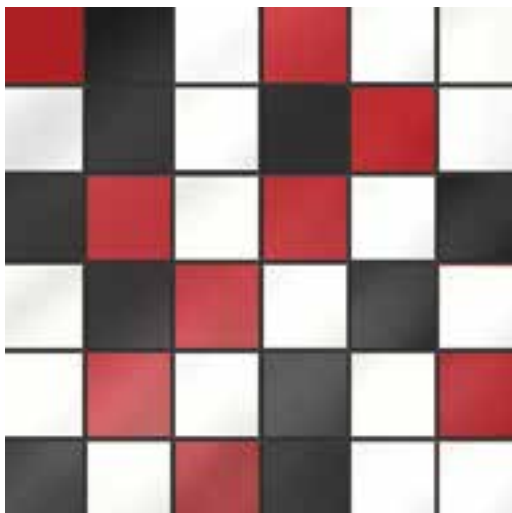

BASIC MIX

M 5x5
Parlak / Glossy K9464158

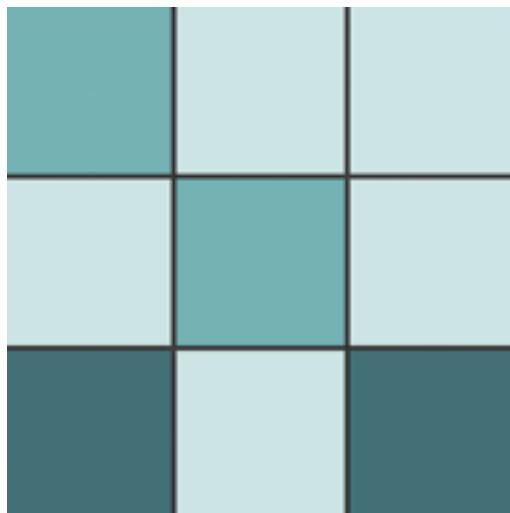

AQUA MIX

M 10x10
Mat / Matt K9464168

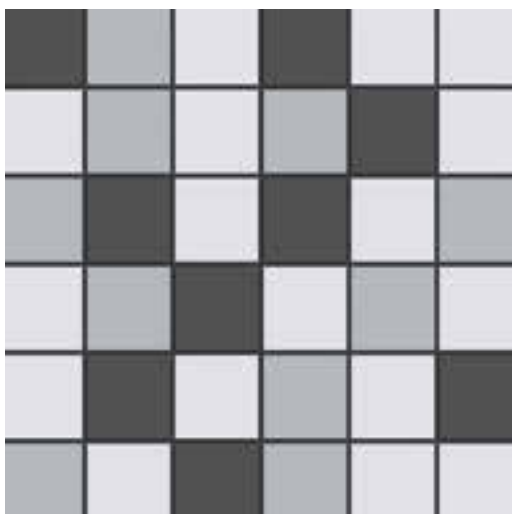

NEUTRAL MIX

M 5x5
Mat / Matt K9464178

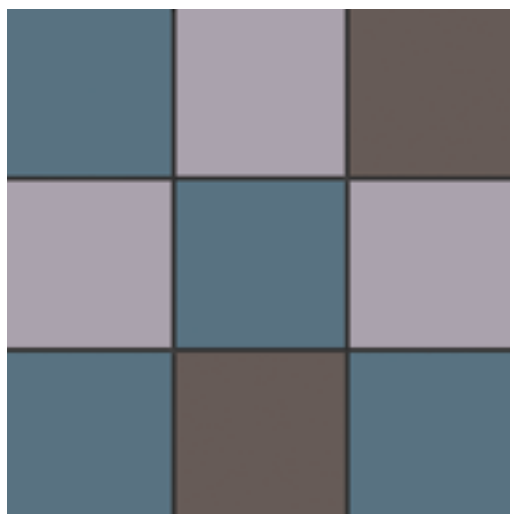

MOOD MIX

M 10x10
Mat / Matt K9464188



GRADIENT MIX

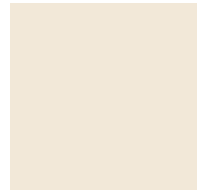

RAL 0809010
Mat / Matt

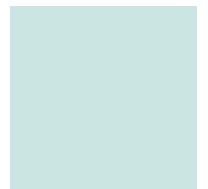

RAL 2008020
Parlak / Glossy



RAL 2606030
Mat / Matt

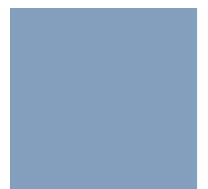

RAL 5002
Mat / Matt

COLOR

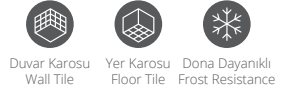

M 12,5 x 25 cm / 5" x 10"
119 x 244 x 6,5 mm
EN14411 Bla

BASIC



RAL 9016

Mat / Matt K762090
Parlak / Glossy K762101
R10B/R10B K770346
C/C K772385
VitrA Photoactive K762090FA



RAL 0001500

Mat / Matt K764503
Parlak / Glossy K764514
R10B/R10B K772363
C/C K772396



RAL 0304050

Mat / Matt K878675

NEUTRAL

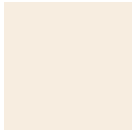

RAL 0809010

Mat / Matt K790152
C/C K891523

AQUA



RAL 2008020
Mat / Matt K775751



RAL 2006020
Mat / Matt K542062



RAL 2307015
Mat / Matt K762112
Parlak / Glossy K762123
R10B/R10B K770350
C/C K772400



RAL 2306020
Parlak / Glossy K891453



RAL 2404020
Mat / Matt K542051



RAL 2606030
Mat / Matt K775795
Parlak / Glossy K775806
R10B/R10B K802883
C/C K896084



RAL 2603035
Mat / Matt K891416
Parlak / Glossy K798436
R10B/R10B K896073
C/C K896095



RAL 5002
Mat / Matt K765015
Parlak / Glossy K765026
R10B/R10B K772352
C/C K772374

COLOR

BASIC

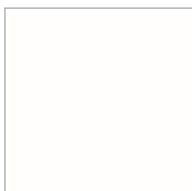

RAL 9016

M 2.5x2.5 Mat / Matt K027703
M 2.5x2.5 Parlak / Glossy K027714
M 5x5 Mat / Matt K504884
M 5x5 Parlak / Glossy K505606
M 5x5 R10B K505002
M 10x10 Mat / Matt K507920
M 10x10 Parlak / Glossy K503823
M 10x10 R9A K518402
M 10x10 R10A K518785
M 10x10 R10B K1BB0060000
M 10x10 C K534583
M 10x20 Mat / Matt K500791
M 10x20 Parlak / Glossy K766356
M 10x20 R10B K500861
M 10x20 C K772223
M 12.5x25 Mat / Matt K762090
M 12.5x25 Parlak / Glossy K762101
M 12.5x25 R10B K770346
M 12.5x25 C K772385
M 10x30 Mat / Matt K785122
M 10x30 Parlak / Glossy K790605
M 15x15 Mat / Matt K110020000
M 15x15 Parlak / Glossy K767972
M 15x15 R10B K110040000
M 20x20 Mat / Matt K780426
M 20x20 Parlak / Glossy K759071
M 20x20 R9A K818034
M 20x20 R10B K130350000
M 30x30 Mat / Matt K1R0010000
M 30x30 Parlak / Glossy K788306
M 30x30 R10B K1R0020000
M 30x60 Mat / Matt K892234
M 30x60 R10A K943765
M 60x60 Mat / Matt K790874
M 10x30D Mat / Matt K086072
M 10x30D Parlak / Glossy K943419
M 15x15D Mat / Matt K210100001
M 15x15D Parlak / Glossy K210100000
M 20x20D Mat / Matt K230030001
M 20x20D Parlak / Glossy K230030000
M 20x40D Mat / Matt K944070
M 20x40D Parlak / Glossy K944071



RAL 0001500

M 2.5x2.5 Mat / Matt K027655
M 2.5x2.5 Parlak / Glossy K027666
M 2.5x2.5 R10A K540544
M 5x5 Mat / Matt K504980
M 5x5 Parlak / Glossy K505654
M 5x5 R10B K523604
M 10x10 Mat / Matt K507975
M 10x10 Parlak / Glossy K505352
M 10x10 R10B K512673
M 10x10 C K534605
M 10x20 Mat / Matt K500684
M 10x20 Parlak / Glossy K776355
M 10x20 R10B K772212
M 12.5x25 Mat / Matt K764503
M 12.5x25 Parlak / Glossy K764514
M 12.5x25 R10B K772363
M 12.5x25 C K772396
M 10x30 Mat / Matt K790594
M 10x30 Parlak / Glossy K794212
M 15x15 Mat / Matt K110020070
M 15x15 Parlak / Glossy K891674
M 20x20 Mat / Matt K780474
M 20x20 Parlak / Glossy K798451
M 30x30 Mat / Matt K1R0010070
M 60x60 Mat / Matt K813753
M 10x30D Mat / Matt K944208



RAL 1105050

M 2.5x2.5 Mat / Matt K542235
M 2.5x2.5 Parlak / Glossy K542250
M 5x5 Mat / Matt K542272
M 5x5 Parlak / Glossy K542294
M 10x10 Mat / Matt K542316
M 10x10 Parlak / Glossy K542331
M 10x20 Mat / Matt K542364
M 10x30 Parlak / Glossy K542386
M 15x15 Mat / Matt K542401
M 20x20 Mat / Matt K943645



RAL 1008080

M 2.5x2.5 Mat / Matt K542224
M 2.5x2.5 Parlak / Glossy K542246
M 5x5 Mat / Matt K542261
M 5x5 Parlak / Glossy K542283
M 10x10 Mat / Matt K542305
M 10x10 Parlak / Glossy K542320
M 10x20 Mat / Matt K542353
M 10x30 Parlak / Glossy K542375
M 15x15 Mat / Matt K542390
M 20x20 Mat / Matt K943634



RAL 0808060

M 2.5x2.5 Mat / Matt K533710
M 2.5x2.5 R10A/R10A K540566
M 5x5 Mat / Matt K534001
M 10x10 Mat / Matt K534373
M 10x30 Mat / Matt K891243
M 15x15 Mat / Matt K891630
M 20x20 Mat / Matt K891862



RAL 1018

M 2.5x2.5 Parlak / Glossy K027611
M 5x5 Parlak / Glossy K504954
M 10x10 Parlak / Glossy K508244
M 15x15 Parlak / Glossy K757033
M 20x20 Parlak / Glossy K760734

RENKLERE GÖRE EBAT DİZİLİMİ SIZE OPTIONS IN COLOR ORDER



RAL 0757070

M 2.5x2.5 Mat / Matt K535246
M 10x10 Mat / Matt K534336
M 10x10 Parlak / Glossy K534524
M 20x20 Mat / Matt K943796



RAL 2003

M 2.5x2.5 Mat / Matt K5204654
M 10x10 Mat / Matt K5299744
M 10x20 Mat / Matt K542342
M 15x15 Mat / Matt K849140
M 20x20 Mat / Matt K943785



RAL 2010

M 2.5x2.5 Parlak / Glossy K529451
M 5x5 Parlak / Glossy K529462
M 10x10 Parlak / Glossy K534513
M 10x30 Parlak / Glossy K860372
M 20x20 Parlak / Glossy K891884



RAL 0304050

M 2.5x2.5 Mat / Matt K526791
M 5x5 Mat / Matt K526813
M 10x10 Mat / Matt K534200
M 12.5x25 Mat / Matt K878675
M 10x30 Mat / Matt K891140
M 15x15 Mat / Matt K891593
M 20x20 Mat / Matt K891836



RAL 3000

M 2.5x2.5 Parlak / Glossy K526426
M 5x5 Parlak / Glossy K5264304
M 10x10 Parlak / Glossy K526441
M 10x20 Parlak / Glossy K526452
M 10x30 Parlak / Glossy K876623
M 15x15 Parlak / Glossy K526463
M 20x20 Parlak / Glossy K526474
M 30x30 Parlak / Glossy K526485

COLOR

AQUA

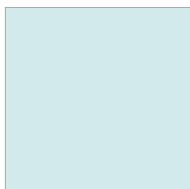

RAL 2008020

M 2.5x2.5 Mat / Matt K027880
M 2.5x2.5 Parlak / Glossy K027876
M 5x5 Mat / Matt K505945
M 5x5 Parlak / Glossy K028296
M 10x10 Mat / Matt K502051
M 10x10 Parlak / Glossy K506553
M 10x20 Mat / Matt K502806
M 12.5x25 Mat / Matt K775751
M 10x30 Mat / Matt K891324
M 15x15 Mat / Matt K891663
M 20x20 Mat / Matt K502191

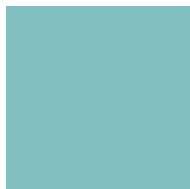

RAL 2006020

M 2.5x2.5 Mat / Matt K541944
M 2.5x2.5 Parlak / Glossy K541966
M 5x5 Mat / Matt K541981
M 5x5 Parlak / Glossy K542003
M 10x10 Mat / Matt K542025
M 10x20 Mat / Matt K542040
M 12.5x25 Mat / Matt K542062
M 20x20 Mat / Matt K943660



RAL 2004030

M 2.5x2.5 Mat / Matt K535272
M 2.5x2.5 Parlak / Glossy K537276
M 10x10 Mat / Matt K534454
M 10x10 Parlak / Glossy K534115
M 20x20 Mat / Matt K943811



RAL 2307015

M 2.5x2.5 Mat / Matt K027891
M 2.5x2.5 Parlak / Glossy K027902
M 2.5x2.5 R10B K529580
M 5x5 Mat / Matt K504976
M 5x5 Parlak / Glossy K505643
M 5x5 R10B K505024
M 10x10 Mat / Matt K1BB0050028
M 10x10 Parlak / Glossy K505341
M 10x10 R10B K1BB0080028
M 10x20 Mat / Matt K500802
M 10x20 Parlak / Glossy K770136
M 10x20 R10B K500813
M 10x20 C K772234
M 12.5x25 Mat / Matt K762112
M 12.5x25 Parlak / Glossy K762123
M 12.5x25 R10B K770350
M 12.5x25 C K772400
M 10x30 Mat / Matt K805756
M 20x20 Mat / Matt K130060028
M 20x20 Parlak / Glossy K891976
M 30x30 Mat / Matt K1R0030028
M 30x30 R10B K892175



RAL 2306020

M 2.5x2.5 Mat / Matt K535305
M 10x10 Mat / Matt K534476
M 12.5x25 Parlak / Glossy K891453
M 20x20 Mat / Matt K943800



RAL 2404020

M 2.5x2.5 Mat / Matt K541933
M 2.5x2.5 Parlak / Glossy K541955
M 5x5 Mat / Matt K541970
M 5x5 Parlak / Glossy K541992
M 10x10 Mat / Matt K542014
M 10x20 Mat / Matt K542036
M 12.5x25 Mat / Matt K542051
M 20x20 Mat / Matt K943656

RENKLERE GÖRE EBAT DİZİLİMİ SIZE OPTIONS IN COLOR ORDER

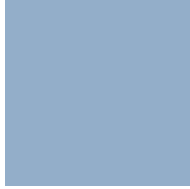

RAL 260630

M 2.5x2.5 Mat / Matt K027935
M 2.5x2.5 Parlak / Glossy K027924
M 5x5 Mat / Matt K504921
M 5x5 Parlak / Glossy K506564
M 10x10 Mat / Matt K502062
M 10x10 Parlak / Glossy K506542
M 10x10 C K541658
M 10x20 Mat / Matt K502810
M 10x20 Parlak / Glossy K776344
M 10x20 R10B K510686
M 12.5x25 Mat / Matt K775795
M 12.5x25 Parlak / Glossy K775806
M 12.5x25 R10B K802883
M 12.5x25 C K896084
M 10x30 Mat / Matt K794326
M 15x15 Mat / Matt K764341
M 20x20 Mat / Matt K502202



RAL 2603035

M 2.5x2.5 Mat / Matt K517142
M 2.5x2.5 Parlak / Glossy K027913
M 5x5 Mat / Matt K505971
M 5x5 Parlak / Glossy K508514
M 10x10 Mat / Matt K534653
M 10x10 Parlak / Glossy K1BB0070087
M 10x10 R10B/R10B 5411660
M 10x20 Parlak / Glossy K502832
M 12.5x25 Mat / Matt K891416
M 12.5x25 Parlak / Glossy K798436
M 12.5x25 R10B K896073
M 12.5x25 C K896095
M 10x30 Mat / Matt K866230
M 10x30 Parlak / Glossy K891361
M 15x15 Mat / Matt K878756
M 20x20 Mat / Matt K759045
M 20x20 Parlak / Glossy K891980



RAL 5002

M 2.5x2.5 Mat / Matt K027644
M 2.5x2.5 Parlak / Glossy K027633
M 2.5x2.5 R10A K540522
M 2.5x2.5 R10B K530582
M 5x5 Mat / Matt K504906
M 5x5 Parlak / Glossy K505632
M 5x5 R10B K510276
M 10x10 Mat / Matt K507964
M 10x10 Parlak / Glossy K505330
M 10x10 R10B K534550
M 10x10 C K530151
M 10x20 Mat / Matt K500695
M 10x20 Parlak / Glossy K776366
M 10x20 R10B K772201
M 10x20 C K772245
M 12.5x25 Mat / Matt K765015
M 12.5x25 Parlak / Glossy K765026
M 12.5x25 R10B K772352
M 12.5x25 C K772374
M 10x30 Mat / Matt K891081
M 10x30 Parlak / Glossy K876656
M 20x20 Mat / Matt K780463
M 20x20 Parlak / Glossy K762230

COLOR

NEUTRAL

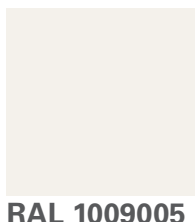

RAL 1009005

M 2.5x2.5 Mat / Matt K527583
M 2.5x2.5 Parlak / Glossy K5338248
M 5x5 Mat / Matt K527642
M 5x5 Parlak / Glossy K534642
M 10x10 Mat / Matt K527701
M 10x10 Parlak / Glossy K534535
M 10x20 Mat / Matt K890963
M 10x30 Mat / Matt K861540
M 10x30 Parlak / Glossy K861551
M 15x15 Mat / Matt K855376
M 20x20 Mat / Matt K855321
M 20x20 Parlak / Glossy K891965
M 10x30D Mat / Matt K944209
M 10x30D Parlak / Glossy K944218

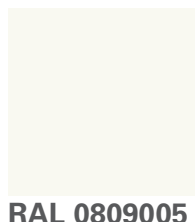

RAL 0809005

M 2.5x2.5 Mat / Matt K027751
M 2.5x2.5 Parlak / Glossy K027762
M 5x5 Mat / Matt K506111
M 5x5 Parlak / Glossy K028215
M 5x5 R10B K511622
M 10x10 Mat / Matt K506122
M 10x10 Parlak / Glossy K506472
M 10x20 Mat / Matt K867206
M 10x30 Mat / Matt K803060
M 10x30 Parlak / Glossy K812681
M 15x15 Mat / Matt K878793
M 20x20 Mat / Matt K761412
M 20x20 Parlak / Glossy K798086
M 20x20 R10B K779612
M 30x30 Mat / Matt K772960

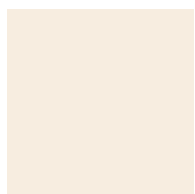

RAL 0809010

M 5x5 Mat / Matt K505842
M 5x5 Parlak / Glossy K508470
M 5x5 R10B K534130
M 10x10 Mat / Matt K505282
M 10x10 Parlak / Glossy K506483
M 10x10 R10B K534561
M 10x20 Parlak / Glossy K779085
M 12.5x25 Mat / Matt K790152
M 12.5x25 C K891523
M 10x30 Mat / Matt K838080
M 10x30 Parlak / Glossy K886262
M 15x15 Mat / Matt K782096
M 20x20 Mat / Matt K808624
M 20x20 Parlak / Glossy K814943
M 20x20 R10B K892035
M 30x30 Mat / Matt K768995
M 30x30 R10B K892164
M 30x60 Mat / Matt K892330

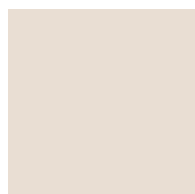

RAL 0808010

M 2.5x2.5 Mat / Matt K5275728
M 5x5 Mat / Matt K527631
M 10x10 Mat / Matt K527690
M 15x15 Mat / Matt K839410
M 20x20 Mat / Matt K855310

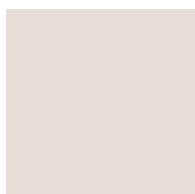

RAL 0958010

M 10x10 Mat / Matt K542073
M 10x20 Mat / Matt K542106
M 10x30 Mat / Matt K542132
M 10x30 Parlak / Glossy K793011
M 15x15 Mat / Matt K542191
M 20x20 Mat / Matt K943671

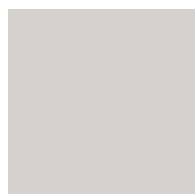

RAL 0007500

M 2.5x2.5 Mat / Matt K027670
M 2.5x2.5 Parlak / Glossy K029755
M 2.5x2.5 R10A/R10A K540533
M 5x5 Mat / Matt K504910
M 5x5 Parlak / Glossy K534104
M 5x5 R10B K505035
M 10x10 Mat / Matt K507986
M 10x10 Parlak / Glossy K511423
M 10x10 R9A K518424
M 10x10 R10A K518796
M 10x10 R10B K1BB0060062
M 10x20 Mat / Matt K502320
M 10x20 Parlak / Glossy K891011
M 10x30 Mat / Matt K793976
M 10x30 Parlak / Glossy K794256
M 15x15 Mat / Matt K502843
M 15x15 R10B K110060062
M 20x20 Mat / Matt K780441
M 20x20 Parlak / Glossy K817765
M 20x20 R9A K818056
M 20x20 R10A K819762
M 20x20 R10B K130350062
M 30x30 Mat / Matt K1R0010062
M 30x30 R10B K1R0020062
M 30x60 Mat / Matt K892315
M 60x60 Mat / Matt K818351
M 10x30D Mat / Matt K944211
M 10x30D Parlak / Glossy K944221

RENKLERE GÖRE EBAT DİZİLİMİ SIZE OPTIONS IN COLOR ORDER

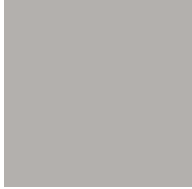

RAL 0806005

M 10x10 Mat / Matt K542084
M 10x20 Mat / Matt K542110
M 10x30 Mat / Matt K542143
M 10x30 Parlak / Glossy K542176
M 15x15 Mat / Matt K542202
M 20x20 Mat / Matt K943682



RAL 0505010

M 10x10 Mat / Matt K542095
M 10x20 Mat / Matt K542121
M 10x30 Mat / Matt K542154
M 10x30 Parlak / Glossy K542180
M 15x15 Mat / Matt K542213
M 20x20 Parlak / Glossy K943693

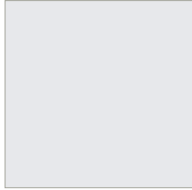

RAL 7047

M 2.5x2.5 Mat / Matt K027681
M 2.5x2.5 Parlak / Glossy K027692
M 5x5 Mat / Matt K504895
M 5x5 Parlak / Glossy K5056108
M 5x5 R10B K505013
M 10x10 Mat / Matt K507931
M 10x10 Parlak / Glossy K504011
M 10x10 R10B K1BB0060064
M 10x10 C K534594
M 10x20 Mat / Matt K502375
M 10x20 Parlak / Glossy K853002
M 10x20 R10B K502876
M 10x20 C K891055
M 10x30 Mat / Matt K794223
M 10x30 Parlak / Glossy K794234
M 15x15 Mat / Matt K794223
M 15x15 Parlak / Glossy K782774
M 15x15 R10B K110060064
M 20x20 Mat / Matt K780430
M 20x20 Parlak / Glossy K798171
M 20x20 R10B K1R0020064
M 30x30 Mat / Matt K1R0010064
M 30x30 R10B K1R0020064
M 30x60 Mat / Matt K788166
M 60x60 Mat / Matt K798020
M 10x30D Mat / Matt K944269
M 10x30D Parlak / Glossy K944219
M 15x15D Mat / Matt K773145
M 20x20D Mat / Matt K775740

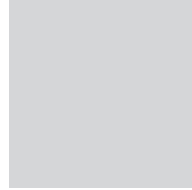

RAL 8000

M 2.5x2.5 Mat / Matt K533614
M 5x5 Mat / Matt K533916
M 10x10 Mat / Matt K534196
M 10x30 Mat / Matt K891136
M 15x15 Mat / Matt K891582
M 20x20 Mat / Matt K891825
M 30x30 Mat / Matt K892083
M 10x30D Mat / Matt K944184

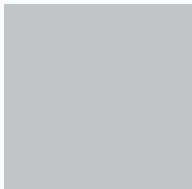

RAL 0005500

M 2.5x2.5 Mat / Matt K029000
M 2.5x2.5 Parlak / Glossy K029011
M 5x5 Mat / Matt K504932
M 5x5 Parlak / Glossy K515753
M 5x5 R10B K505046
M 10x10 Mat / Matt K507942
M 10x10 Parlak / Glossy K507334
M 10x10 R10B K503005
M 10x20 Mat / Matt K502725
M 10x20 Parlak / Glossy K891000
M 10x30 Mat / Matt K785914
M 10x30 Parlak / Glossy K794245
M 15x15 Mat / Matt K502854
M 15x15 Parlak / Glossy K782785
M 20x20 Mat / Matt K502095
M 20x20 Parlak / Glossy K798182
M 30x30 Mat / Matt K754445
M 30x60 Mat / Matt K892282
M 60x60 Mat / Matt K813731
M 10x30D Mat / Matt K944210



RAL 0004000

M 2.5x2.5 Mat / Matt K515484
M 2.5x2.5 Parlak / Glossy K522786
M 5x5 Mat / Matt K524433
M 5x5 Parlak / Glossy K509085
M 5x5 R10B K535401
M 10x10 Mat / Matt K507905
M 10x10 Parlak / Glossy K520513
M 10x10 R10B K535423
M 10x30 Mat / Matt K790480
M 10x30 Parlak / Glossy K794260
M 15x15 Parlak / Glossy K891685
M 20x20 Mat / Matt K781492
M 20x20 Parlak / Glossy K891895
M 30x30 Mat / Matt K864605
M 60x60 Mat / Matt K892341

COLOR

MOOD



RAL 3004

M 2.5x2.5 Mat / Matt K029501
M 5x5 Parlak / Glossy K506822
M 10x10 Mat / Matt K508163
M 10x30 Parlak / Glossy K799711
M 20x20 Mat / Matt K780495



RAL 0504040

M 10x10 Mat / Matt K541653
M 10x30 Parlak / Glossy K086083
M 20x20 Mat / Matt K943704



RAL 0706040

M 10x10 Mat / Matt K541686
M 10x30 Parlak / Glossy K086116
M 20x20 Mat / Matt K943730



RAL 2904015

M 10x10 Mat / Matt K541690
M 10x30 Parlak / Glossy K086120
M 20x20 Mat / Matt K943741

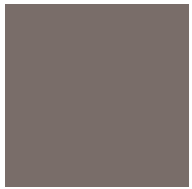

RAL 0404005

M 10x10 Mat / Matt K541701
M 10x30 Parlak / Glossy K086131
M 20x20 Mat / Matt K943752



RAL 0606020

M 10x10 Mat / Matt K541664
M 10x30 Parlak / Glossy K086094
M 20x20 Mat / Matt K943715

RENKLERE GÖRE EBAT DİZİLİMİ SIZE OPTIONS IN COLOR ORDER

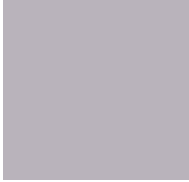

RAL 0206005

M 10x10 Mat / Matt K541712
M 10x30 Parlak / Glossy K086142
M 20x20 Mat / Matt K943763

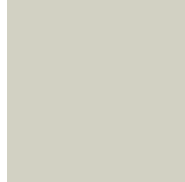

RAL 1007010

M10x10 Mat / Matt K541723
M 10x30 Parlak / Glossy K086153
M 20x20 Mat / Matt K943774

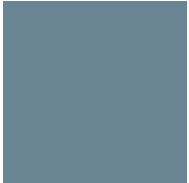

RAL 2205005

M 10x10 Mat / Matt K541675
M 10x30 Parlak / Glossy K086105
M 20x20 Mat / Matt K943726

COLOR

TRIMS

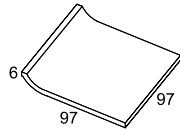
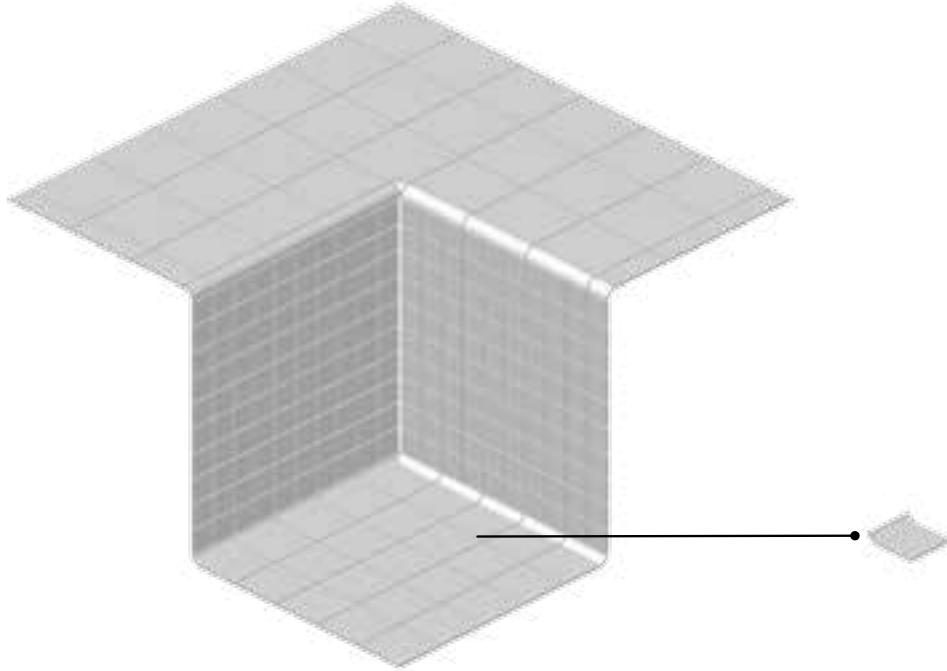

Kenar dönüş parçası
Covebase
M 10 x 10 cm / 4" x 4"
97 x 97 x 6 mm
EN14411 B1b



RAL 9016

Mat / Matt K505212
Mat / Matt R10B K506192

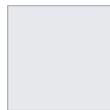

RAL 7047

Mat / Matt K505223
Mat / Matt R10B K506181



RAL 0007500

Mat / Matt K506391
Mat / Matt R10B K511681



RAL 0005500

Mat / Matt K020250
Mat / Matt R10B K027386



RAL 0958010

Mat / Matt K506634



RAL 0004000

Mat / Matt K905823
Mat / Matt R10B K905834

TAMAMLAYICI PARÇALAR COMPLEMENTARY PARTS

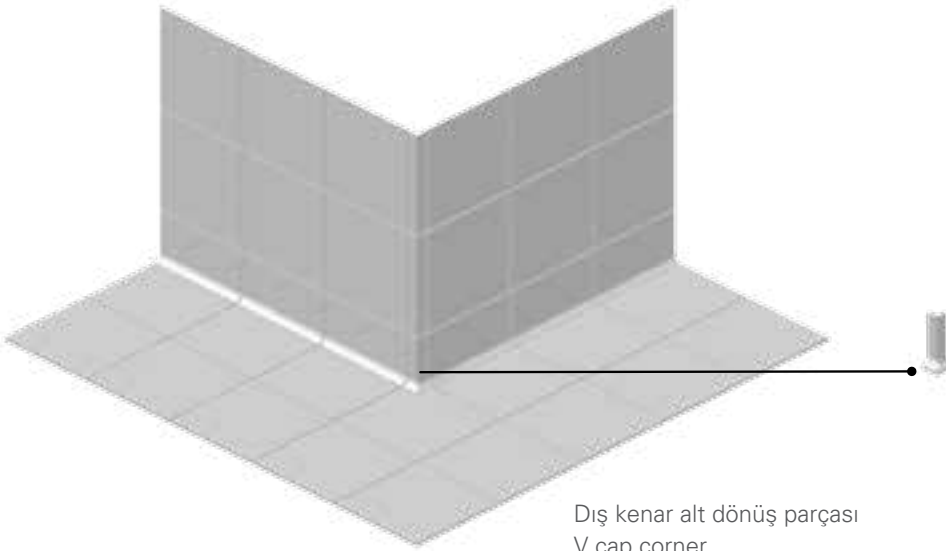

Dış kenar alt dönüş parçası
V çap corner
M 3 x 10 cm / 1" x 4"
6 mm
EN14411 Blb

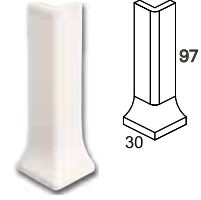

RAL 9016
Mat / Matt K759955
Parlak / Glossy K808904



RAL 7047
Mat / Matt K759970



RAL 0958010
Mat / Matt K860512



RAL 0001500
Mat / Matt K874722

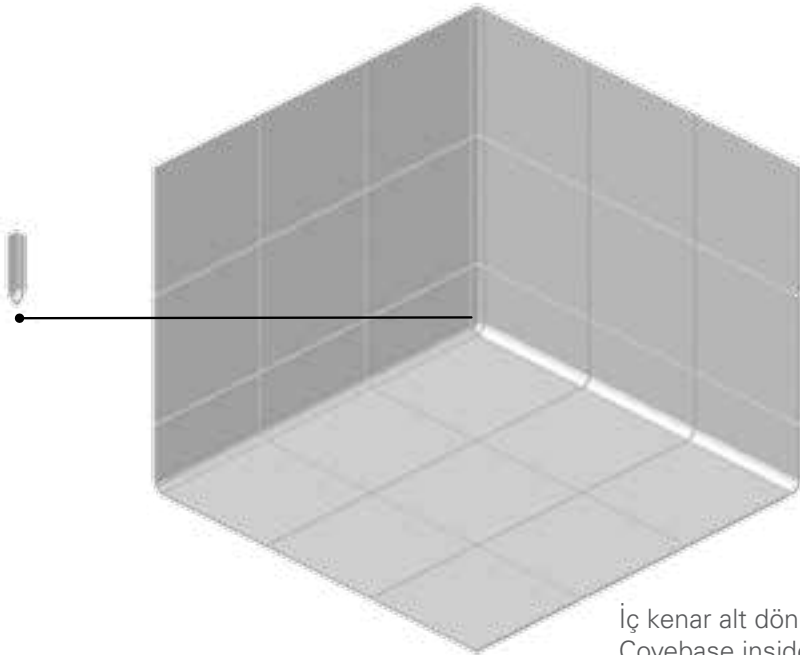

İç kenar alt dönüş parçası
Covebase inside corner
M 2.5 x 10 cm / 1" x 4"
6 mm
EN14411 Blb

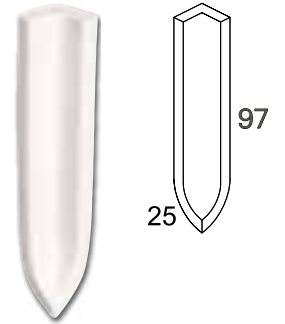

RAL 9016
Mat / Matt K759874

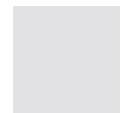

RAL 7047
Mat / Matt K759896



RAL 0958010
Mat / Matt K776440



RAL 0001500
Mat / Matt K874696

COLOR

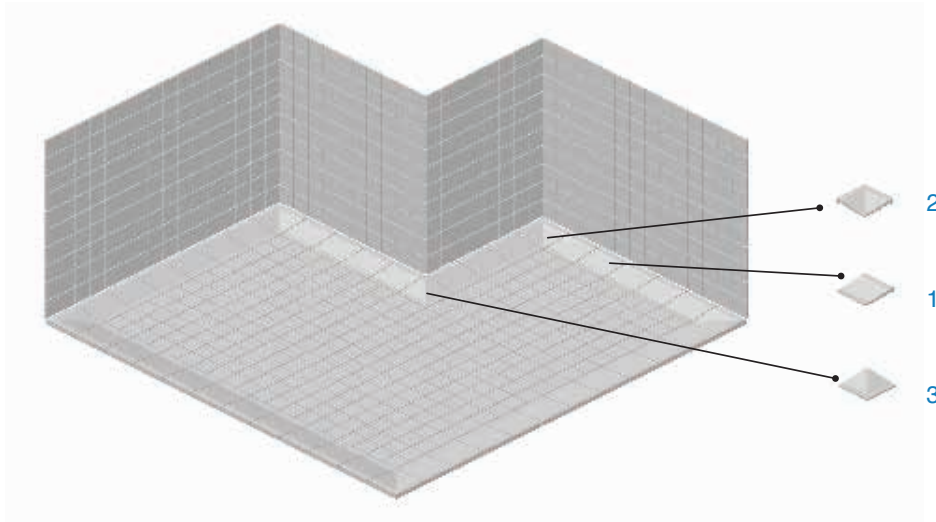

1

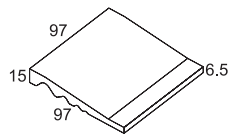

Duş parçası
Shower inclined end edge
M 10 x 10 cm / 4" x 4"
97 x 97 x 6.5-15 mm
EN14411 B1b



RAL 9016
Mat/Matt R10B K782505



RAL 7047
Mat/Matt R10B K784281



RAL 0005500
Mat/Matt R10B K893704

2

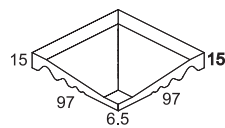

Duş parçası iç köşe
Shower inclined
end edge (internal)
M 10 x 10 cm / 4" x 4"
97 x 97 x 6.5-15 mm
EN14411 B1b



RAL 9016
Mat/Matt R10B K782516



RAL 7047
Mat/Matt R10B K784292

3

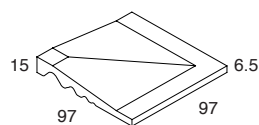

Duş parçası dış köşe
Shower inclined end
edge (external)
M 10 x 10 cm / 4" x 4"
97 x 97 x 6.5-15 mm
EN14411 B1b



RAL 9016
Mat/Matt R10B K782520

TAMAMLAYICI PARÇALAR COMPLEMENTARY PARTS

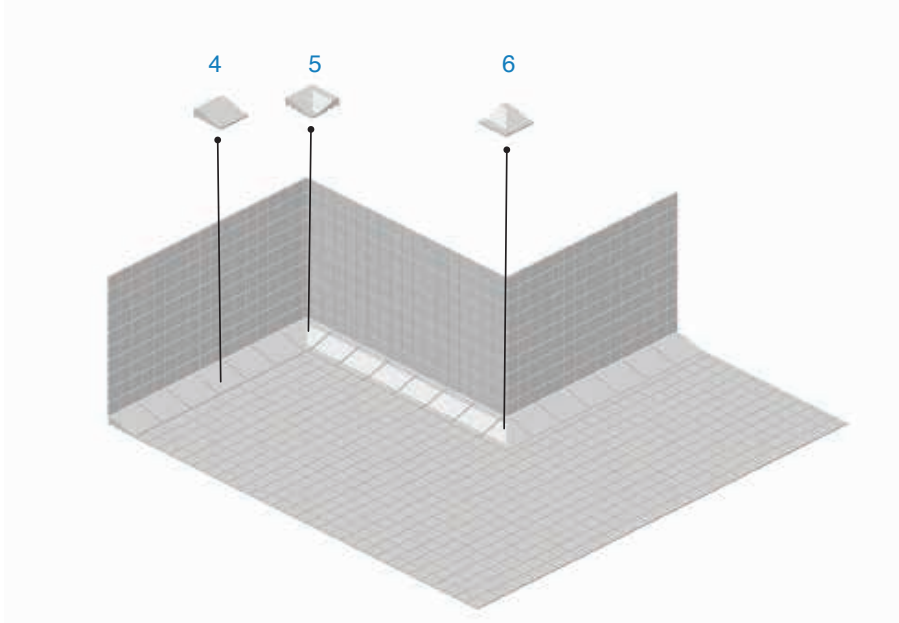

4

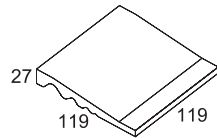

Duş parçası
Shower inclined end edge
M 12.5 x 12.5 cm / 5" x 5"
119 x 119 x 27 mm
EN14411 Blb



RAL 7047
Mat/Matt R10B K790900

5

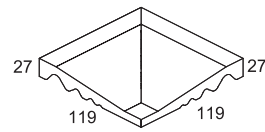

Duş parçası iç köşe
Shower inclined end
edge (internal)
M 12.5 x 12.5 cm / 5" x 5"
119 x 119 x 27 mm
EN14411 Blb



RAL 7047
Mat/Matt R10B K790896

6

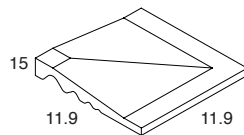

Duş parçası dış köşe
Shower inclined
end edge (external)
M 12.5 x 12.5 cm / 5" x 5"
119 x 119 x 27 mm
EN14411 Blb



RAL 7047
Mat/Matt R10B K837004

HAVUZ KAROLARI / RENKLER & EBATLAR

POOL TILES / COLORS & SIZES

	PEI		2.5x2.5				5x5			* 10x10					10x20				
	Mat/Mat	Parlak/Glossy	Mat/Mat	Parlak/Glossy	R10B	R10A	Mat/Mat	Parlak/Glossy	R10B	Mat/Mat *	Parlak/Glossy	R9A	R10A	R10B	C	Mat/Mat	Parlak/Glossy	R10B	C
RAL 9016	4	3	x	x	x		x	x	x	x	x	x	x	x	x	x	x	x	x
RAL 0001500	2	2	x	x	x	x	x	x	x	x	x			x	x	x	x	x	
RAL 1105050	3	2	x	x			x	x		x	x				x				
RAL 1008080	3	2	x	x			x	x		x	x				x				
RAL 1018 / RAL 0808060	3	3	x	x		x	x	x	x	x	x								
RAL 0757070	3	2	x			x				x	x		x						
RAL 2003 / RAL 2010	2	2	x	x				x		x	x				x				
RAL 0304050 / RAL 3000	2	2	x	x			x	x		x	x					x	x		
RAL 2006020	3	2	x	x			x	x		x	x				x				
RAL 2006020	3	2	x	x			x	x		x					x				
RAL 2004030	2	2	x	x						x	x								
RAL 2307015	4	3	x	x	x		x	x	x	x	x			x	x	x	x	x	x
RAL 2306020	3		x							x									
RAL 2404020	2	2	x	x			x	x		x					x				
RAL 2606030	3	2	x	x			x	x		x	x				x	x	x	x	
RAL 2603035	2	2	x	x			x	x		x	x			x	x	x	x		
RAL 5002	2	2	x	x	x		x	x	x	x	x			x	x	x	x	x	x
RAL 1009005	4	3	x	x			x	x		x	x				x				
RAL 0809005	4	3	x	x			x	x	x	x	x				x				
RAL 0809010	4	3					x	x	x	x	x			x	x	x			
RAL 0806010	4		x				x			x									
RAL 0958010	4	3								x					x				
RAL 0007500	3	2	x	x	x	x	x	x	x	x	x	x	x	x	x	x	x		
RAL 0806005	3	2								x					x				
RAL 0506010	3	2								x					x				
RAL 7047	4	3	x	x			x	x	x	x	x			x	x	x	x	x	x
RAL 8000	3		x				x			x									
RAL 0005500	3	2	x	x			x	x	x	x	x			x		x	x		
RAL 0004000	2	2	x	x			x	x	x	x	x			x					
RAL 3004	2	2	x					x		x									
RAL 0504040	2	2								x									
RAL 0706040	3	2								x									
RAL 2904015	2	2								x									
RAL 0404005	2	2								x									
RAL 0806020	3	2								x									
RAL 0206005	3	2								x									
RAL 1007010	4	3								x									
RAL 2205005	2	2								x									

* M10x10 ebadında tüm mat renkler mevcuttur.

All matt colors are available in M10x10.

M20x20 ebadında tüm mat renkler mevcuttur.

All matt colors are available in M20x20.

COLOR

BASIC

Sırlı / Glazed



RAL 9016
Beyaz
White



RAL 0001500
Siyah
Black



RAL 1105050
Yeşil
Green



RAL 1008080
Limon Yeşili
Lime Green



RAL 0808060
Sarı
Yellow
Mat / Matt

RAL 1018
Parlak / Glossy

Sırsız / Fullbody



Uni Süper Beyaz
Uni Super White
Mat/Matt



Uni Süper Siyah
Uni Super Black
Mat/Matt

AQUA

Sırlı / Glazed



RAL 2008020
Cam Göbeği
Calipso



RAL 2006020
Turkuaz
Turquoise



RAL 2004030
Koyu Turkuaz
Dark Turquoise



RAL 2307015
Havuz Mavisi
Pool Blue



RAL 2306020
Mavi
Blue

Sırsız / Fullbody



Uni Mavi
Uni Blue
Mat / Matt

COLOR VE UNI UYUM TABLOSU COLOR AND UNI MATCHING TABLE



RAL 0757070
Koyu Sarı
Dark Yellow



RAL 2003
Turuncu
Orange
Mat / Matt

RAL 2010
Parlak / Glossy



RAL 0304050
Kırmızı
Red
Mat / Matt

RAL 3000
Parlak / Glossy



RAL 2404020
Okyanus Mavisi
Ocean Blue



RAL 2606030
Soğuk Mavi
Cool Blue



RAL 2603035
Göl Mavisi
Aqua Blue



RAL 5002
Kobalt Mavi
Cobalt Blue



Uni Kobalt Mavi
Uni Cobalt Blue
Mat / Matt



Uni Iris Mavi
Uni Iris Blue
Mat / Matt

COLOR

NEUTRAL

Sırlı / Glazed



RAL 1009005
Ultra Beyaz
Ultra White



RAL 0809005
Krem
Biscuit

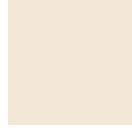

RAL 0809010
Açık Kum Beji
Light Sand



RAL 0808010
Kum Beji
Sand

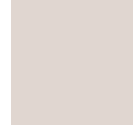

RAL 0958010
Açık Vizon
Light Mink



RAL 0007500
Grej
Greige

Sırsız / Fullbody



Uni Market Beyaz
Uni Market White
Mat / Matt



Uni Fildişi
Uni Ivory
Mat / Matt



Uni Kum Beji
Uni Sand
Mat / Matt



Uni Grafit Gri
Uni Graphite Grey
Mat / Matt



Uni Koyu Vizon
Uni Dark Mink
Mat / Matt



Uni Gümüş
Uni Silver
Mat / Matt

MOOD

Sırlı / Glazed



RAL 3004
Bordo
Burgundy



RAL 0504040
Taba
Tobacco



RAL 0706040
Toprak Sarısı
Ochre Yellow



RAL 2904015
Mürdüm
Plum



RAL 0404005
Basalt Kahve
Bazalt Brown



RAL 0606020
Tatlı Kahve
Soft Brown

Sırsız / Fullbody

COLOR VE UNI UYUM TABLOSU COLOR AND UNI MATCHING TABLE



RAL 0806005
Koyu Grej
Dark Greige



RAL 0505010
Vizon
Mink

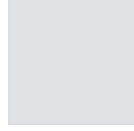

RAL 7047
Açık Gri
Light Grey

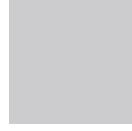

RAL 0008000
Gri
Grey



RAL 0005500
Koyu Gri
Dark Grey



RAL 0004000
Antrasit
Anthracite

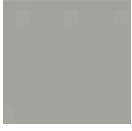

Uni Çimento Gri
Uni Cement Grey
Mat / Matt

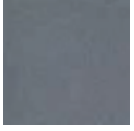

Uni Gri
Uni Grey
Mat / Matt



Uni Siyah
Uni Black
Mat / Matt



RAL 0206005
Leylak
Whisper Lilac



RAL 1007010
Açık Haki
Light Khaki



RAL 2205005
Prusya Mavisi
Prussian Blue



Uni Vizon
Uni Mink
Mat / Matt



BEYOND FUNCTION

FONKSİYONUN ÖTESİNDE

Yaşayan mekanlar, değişen ihtiyaçlar ve çeşitlenen beklentileri karşılayacak zengin bir çözüm paleti, size hayalinizdeki tasarımı sınırsızca gerçeğe dönüştürme fırsatı sunuyor.

A wide range of solutions which will meet all requirements of living spaces, changing needs and diverse expectations gives you the opportunity to make your dream design come true.

FUNCTION

Porselen Karolar / Porcelain Tiles

Bünye / Body Type

Fullbody

Yüzey Alternatifleri / Surface Alternatives

Mat / Matt

R9

R10A

Diamond

Corund

Mercato

Rondo

Resista

Fon Ebatları / Basic Tile Sizes

M2,5x2,5 cm (23x23x6 mm)

M5x5 cm (47x47x6 mm)

M10x10 cm (97x97x6 mm)

M15x15 cm (147x147x8 mm)

M20x20 cm (197x197x8 mm)

M30x30 cm (297x297x8 mm)

M30x60 cm (297x597x9 mm)

M60x60 cm (597x597x9 mm)

Fon Renkleri / Basic Tile Colors

Uni Süper Beyaz / Uni Super White

Uni Market Beyaz / Uni Market White

Uni Gümüş / Uni Silver

Uni Fildişi / Uni Ivory

Uni Kum Beji / Uni Sand

Uni Iris Mavi / Uni Iris Blue

Uni Mavi / Uni Blue

Uni Kobalt Mavi / Uni Cobalt Blue

Uni Vizon / Uni Mink

Uni Koyu Vizon / Uni Dark Mink

Uni Gri / Uni Grey

Uni Çimento Gri / Uni Cement Grey

Uni Grafit Gri / Uni Graphite Grey

Uni Siyah / Uni Black

Uni Süper Siyah / Uni Super Black

Kullanım Alanları / Usage Areas

Konut / Residential

Ticari Alan / Commercial

Döşeme Alanları / Tiling Areas

Yer / Floor

Duvar / Wall

Dona Dayanım / Frost Resistance

Var / Available

Desen Farklılaşması / Shade Variation Classification

V0

Ürün Standardı / Product Standard

EN14411 Group Bla

UNI

FUNCTION KOLEKSİYONUNUN TEMEL RENKLERİNİ

BİR ARAYA GETİREN UNI ÜRÜN AİLESİ, SICAK TOPRAK

RENKLERİNDEN BEYAZ TONLARINA, MAVİDEN GRİ RENK

SEÇENEKLERİNE PEK ÇOK FARKLI RENK ALTERNATİFİNİ FARKLI

EBATLARDA SUNUYOR. FULLBODY PORSELEN YAPISIYLA HER

TÜRLÜ AŞINMAYA KARŞI EKSTRA DAYANIKLILIK SUNAN

UNI ÜRÜN GRUBU KAROLARI, 15 FARKLI RENK SEÇENEĞİNİ

8 AYRI EBATTA BİR ARAYA GETİRİYOR.

UNI PRODUCT FAMILY WHICH COMBINES THE BASIC COLORS OF

FUNCTION COLLECTION OFFERS VARIOUS COLOR ALTERNATIVES

FROM WARM EARTH COLORS TO WHITE HUES, FROM BLUE TO

GREY COLOR OPTIONS, IN DIFFERENT SIZES. UNI TILES OFFERING

EXTRA RESISTANCE AGAINST ABRASION WITH THEIR FULLBODY

PORCELAIN STRUCTURE PRESENT 15 DIFFERENT COLOR OPTIONS

AND 8 DIFFERENT SIZES.



Porselen
Porcelain



Yer Karosu
Floor Tile



Duvar Karosu
Wall Tile



Dış Cephe
Facade



Konut
Residential



Ticari Alan
Commercial



Havuz Çevresi
Pool Surrounding



Garajlar ve Otomobil
Galerileri
Garages and Car
Showrooms



Endüstriyel Alan
Industrial Area



Dış Mekanlar
Outdoors



Dona Dayanım
Frost Resistance



Mat
Matt



Desen Farklılaşması
Shade Variation



Rektifiyesiz
Non Rectified



Modülerlik
Modularity



FUNCTION

Porselen Karolar / Porcelain Tiles

Bünye / Body Type

Fullbody

Yüzey Alternatifleri / Surface Alternatives

R9

R10A

R10B

Diamond

Corund

Mercato

Canali

Resista

Fon Ebatları / Basic Tile Sizes

M5x5 cm (47x47x6 mm)

M10x10 cm (97x97x6 mm)

M15x15 cm (147x147x8 mm)

M20x20 cm (197x197x8 mm)

M30x30 cm (297x297x8 mm)

M30x60 cm (297x597x9 mm)

M60x60 cm (597x597x9 mm)

Fon Renkleri / Basic Tile Colors

Dotti Fildişi / Dotti Ivory

Dotti Açık Bej / Dotti Light Beige

Dotti Taupe

Dotti Açık Gri / Dotti Light Grey

Dotti Taba / Dotti Tobacco

Dotti Koyu Gri / Dotti Dark Grey

Kullanım Alanları / Usage Areas

Konut / Residential

Ticari Alan / Commercial

Döşeme Alanları / Tiling Areas

Yer / Floor

Duvar / Wall

Dona Dayanım / Frost Resistance

Var / Available

Desen Farklılaşması / Shade Variation Classification

V0

Ürün Standardı / Product Standard

EN14411 Group Bla

DOTTI

BENEKLİ DOKUSU İLE YOĞUN TRAFİK ALAN MEKANLARDA UZUN SÜRELİ TEMİZLİK HİSSİ VEREN DOTTI, SIK VE KÜÇÜK BENEKLERDEN OLUŞTUĞU İÇİN ÖZELLİKLE TİCARİ VE KAMU PROJELERİNDE TERCİH EDİLİYOR. FULLBODY PORSELEN YAPISIYLA HER TÜRLÜ AŞINMAYA KARŞI EKSTRA DAYANIKLILIK SUNAN DOTTI ÜRÜN GRUBU KAROLARI, 6 FARKLI RENK SEÇENEĞİNİ 7 AYRI EBATTA BİR ARAYA GETİRİRKEN, AÇIK VE KOYU GRİ RENGİ PROJELERİN VAZGEÇİLMEZİ OLUYOR.

DOTTI PRODUCT FAMILY OF FUNCTION COLLECTION, WHICH DIFFERENTIATES WITH ITS TINY DOTTED STRUCTURE, OFFERS DIFFERENT TINTS AND SHADES OF COLORS, IN APPEARANCES CLOSEST TO NATURAL MATERIAL ALTERNATIVES AND IN DIFFERENT SIZES. DOTTI TILES OFFERING EXTRA RESISTANCE AGAINST ABRASION WITH THEIR FULLBODY PORCELAIN STRUCTURE PRESENT 6 DIFFERENT COLOR OPTIONS AND 7 DIFFERENT SIZES. LIGHT AND DARK GRAY COLORS ARE INDISPENSABLE FOR THE PROJECTS.



Porselen
Porcelain



Yer Karosu
Floor Tile



Duvar Karosu
Wall Tile



Konut
Residential



Ticari Alan
Commercial



Havuz Çevresi
Pool Surrounding



Garajlar ve Otomobil
Galerileri
Garages and Car
Showrooms



Endüstriyel Alan
Industrial Area



Diş Mekanlar
Outdoors



Dona Dayanım
Frost Resistance



Mat
Matt



Desen Farklılaşması
Shade Variation



Rektifiyesiz
Non Rectified



Modülerlik
Modularity

FUNCTION

Porselen Karolar / Porcelain Tiles

Bünye / Body Type

Fullbody

Yüze Alternatifleri / Surface Alternatives

Mat / Matt

R9

R10A

R10B

Diamond

Corund

Mercato

Fon Ebatları / Basic Tile Sizes

M5x5 cm (47x47x6 mm)

M10x10 cm (97x97x6 mm)

M20x20 cm (197x197x8 mm)

M30x30 cm (297x297x8 mm)

M30x60 cm (297x597x9 mm)

Fon Renkleri / Basic Tile Colors

Color Dot Süper Beyaz / Color Dot Super White

Color Dot Bej / Color Dot Beige

Color Dot Gümüş / Color Dot Silver

Color Dot Çimento Gri / Color Dot Cement Grey

Color Dot Gri / Color Dot Grey

Color Dot Vizon / Color Dot Mink

Color Dot Grafit Gri / Color Dot Graphite Grey

Color Dot Antrasit / Color Dot Anthracite

Kullanım Alanları / Usage Areas

Konut / Residential

Ticari Alan / Commercial

Döşeme Alanları / Tiling Areas

Yer / Floor

Duvar / Wall

Dona Dayanım / Frost Resistance

Var / Available

Desen Farklılaşması / Shade Variation Classification

V0

Ürün Standardı / Product Standard

EN14411 Group Bla

COLOR DOT

FUNCTION KOLEKSİYONUNUN FARKLI RENK VE TONLARDA BENEKLER İÇEREN ÜRÜN AİLESİ COLOR DOT, GÜMÜŞTEN GRİYE, ALTINDAN VİZON RENGİNE, GÖZ ALICI VE ÇEKİCİ BİRÇOK RENGİ BÜNYESİNDE BARINDIRIYOR. BENEKLERİNİN FARKLI RENKLERİ İLE KARO DÖŞENEN YÜZEYE TASARIM ZENGİNLİĞİ KATAN COLOR DOT, MODÜLER UYGULAMA ÖZGÜRLÜĞÜ SUNAN FARKLI BOYUT SEÇENEKLERİNE SAHİP.

FULLBODY PORSELEN YAPISIYLA HER TÜRLÜ AŞINMAYA KARŞI EKSTRA DAYANIKLILIK SUNAN COLOR DOT ÜRÜN GRUBU KAROLARI, 8 FARKLI RENK SEÇENEĞİNİ 5 AYRI EBATTA BİR ARAYA GETİRİYOR. MİMARLAR, ÖZELLİKLE COLOR DOT ANTRASİT RENGİ TERCİH EDİYOR.

COLOR DOT PRODUCT FAMILY OF FUNCTION COLLECTION, WHICH INCLUDES DOTS IN DIFFERENT HUES AND TONES, INCORPORATES MANY EYE-CATCHER AND ATTRACTIVE COLORS FROM SILVER TO GREY, GOLDEN TO MINK. COLOR DOT, ADDING DESIGN RICHNESS TO TILED SURFACES WITH VARIOUS COLOR OF THE DOTS, PRESENTS VARIOUS SIZE OPTIONS OFFERING THE FREEDOM OF MODULAR APPLICATION.

COLOR DOT TILES OFFERING EXTRA RESISTANCE AGAINST ABRASION WITH THEIR FULLBODY PORCELAIN STRUCTURE PRESENT 8 DIFFERENT COLOR OPTIONS AND 5 DIFFERENT SIZES. ARCHITECTS FAVOURITE COLOR FOR COLOR DOT PRODUCTS IS ANTHRACITE.



Porselen
Porcelain



Yer Karosu
Floor Tile



Duvar Karosu
Wall Tile



Konut
Residential



Ticari Alan
Commercial



Havuz Çevresi
Pool Surrounding



Garajlar ve Otomobil
Galerileri
Garages and Car
Showrooms



Endüstriyel Alan
Industrial Area



Dış Mekanlar
Outdoors



Dona Dayanım
Frost Resistance



Mat
Matt



Desen Farklılaşması
Shade Variation

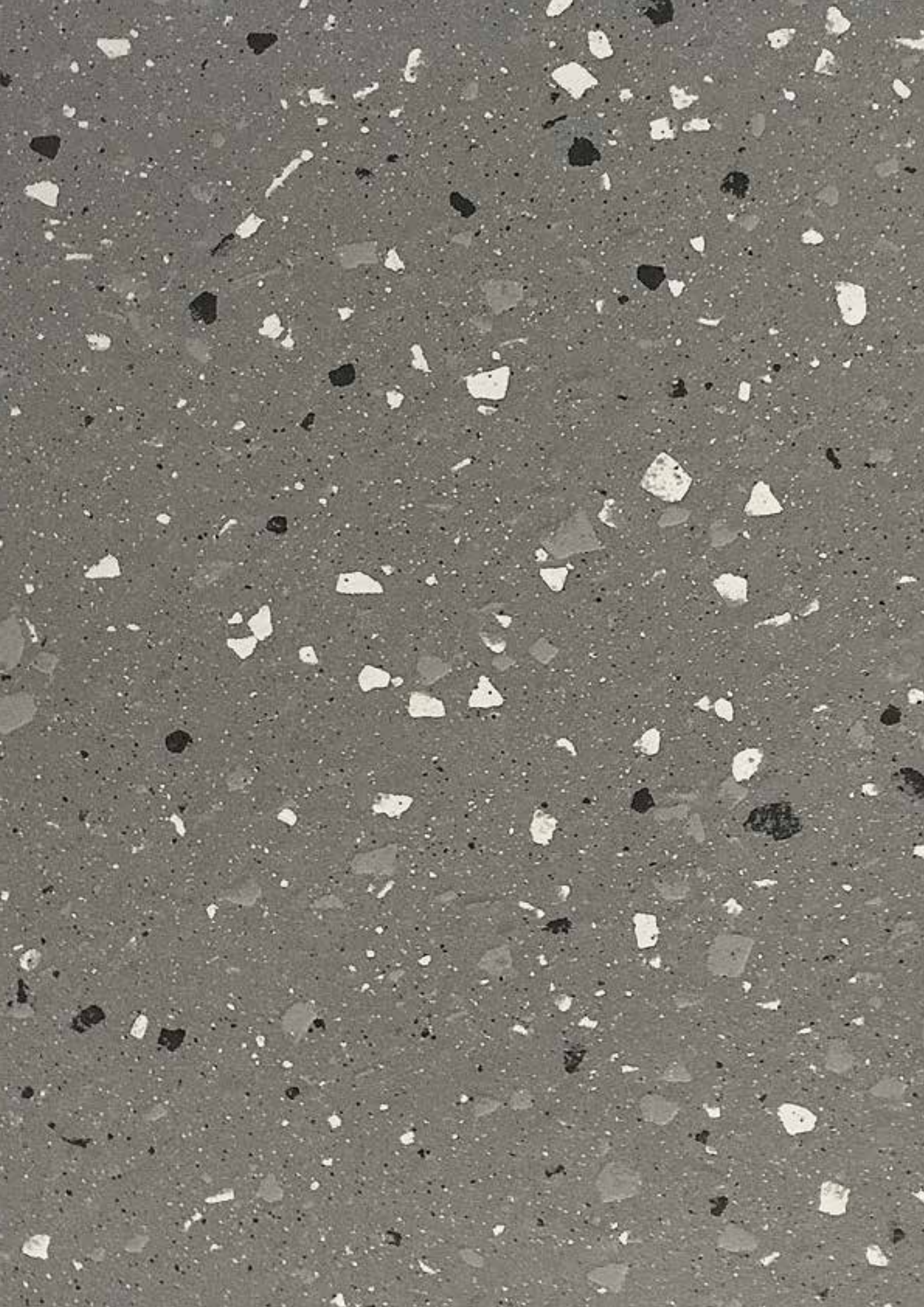

FUNCTION

Porselen Karolar / Porcelain Tiles

Bünye / Body Type

Fullbody

Yüzey Alternatifleri / Surface Alternatives

R9

R10

Fon Ebatları / Basic Tile Sizes

M30x30 cm (297x297x8 mm)

Fon Renkleri / Basic Tile Colors

Beyaz / White

Gri / Grey

Siyah / Black

Kullanım Alanları / Usage Areas

Konut / Residential

Ticari Alan / Commercial

Döşeme Alanları / Tiling Areas

Yer / Floor

Duvar / Wall

Dona Dayanım / Frost Resistance

Var / Available

Desen Farklılaşması / Shade Variation Classification

V1

Ürün Standardı / Product Standard

EN14411 Group Bla

MAKSI FLAKE

FUNCTION KOLEKSİYONUNUN FARKLI RENK TANELERİ İÇEREN ÜRÜN AİLESİ MAKSI FLAKE, YENİ TANELİ GÖVDE DESENLERİYLE BENZER PORSELEN KARO ÜRÜNLERİNDEN AYRIŞIYOR. RENK TANELERİNİN BENZERSİZ YÜZEY ZENGİNLİĞİ İLE MAKSI FLAKE, MİNİ TERRAZZO ETKİSİ VEREREK UZUN SÜRELİ ZAMANSIZ TASARIM İMKANI SUNAR. FULLBODY PORSELEN YAPISIYLA HER TÜRLÜ AŞINMAYA KARŞI EKSTRA DAYANIKLILIK SUNAN MAKSI FLAKE ÜRÜN GRUBU KAROLARI, 3 FARKLI BERABER DÖŞEMEYE UYUMLU (BEYAZ, GRİ, SİYAH) RENK SEÇENEĞİ SUNUYOR.

MAKSI FLAKE PRODUCT FAMILY OF FUNCTION COLLECTION, WHICH INCLUDES VARIOUS COLOR BEADS, DIFFERENTIATES FROM SIMILAR PORCELAIN TILE PRODUCTS WITH ITS NEW BEAD BODY TEXTURES. THANKS TO THE UNIQUE SURFACE RICHNESS OF THE COLOR BEADS, GIVING THE MINI TERRAZZO EFFECT, MAKSI FLAKE OFFERS THE POSSIBILITY OF MAKING LONG-TERM AND TIMELESS DESIGNS.



Porselen
Porcelain



Yer Karosu
Floor Tile



Duvar Karosu
Wall Tile



Konut
Residential



Ticari Alan
Commercial



Dış Mekanlar
Outdoors



Dona Dayanım
Frost Resistance



Mat
Matt



Desen Farklılaşması
Shade Variation



Rektifiyesiz
Non Rectified



Modülerlik
Modularity

FUNCTION

UNI

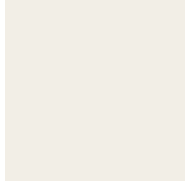

5x5 R10B K508864
10x10 R10B K507382
20x20 R9 K835560
20x20 R10A K776720
30x30 R9 K835910
30x60 Mat/Matt K783916
60x60 R9 K776495

Süper Beyaz / Super White

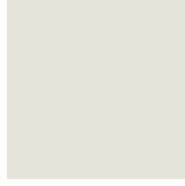

5x5 Mat / Matt K5249824
10x10 R10B K524993
20x20 R9 K816343
30x30 R9 K843514

Market Beyaz / Market White

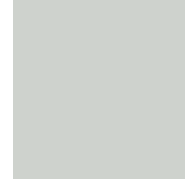

5x5 R10B K511246
20x20 Mat / Matt K820694
30x30 R9 K835836
30x30 R10A K805163
60x60 R9 K827872

Gümüş / Silver



2.5x2.5 R10B K028016
5x5 R10B K505680
10x10 R10B K757441
15x15 R9 K835184
20x20 R9 K835501
20x20 R10A K758744
30x30 R9 K835803
30x30 R10A K751645
30x60 R9 K766986
60x60 R9 K768704

Fildişi / Ivory



10x10 R10B K527362

Kum Beji / Sand



5x5 R10B K527325
10x10 R10B K527384
15x15 R10B K943122
20x20 R9 K854831
30x30 R9 K854853

Çimento Gri / Cement Grey



5x5 R10B K505691

Mavi / Blue



5x5 R10B K5226835

İris Mavi / Irish Blue



5x5 R10B K7768457

Kobalt Mavi / Cobalt Blue



10x10 R10B K534944

Vizon / Mink



5x5 R10B K506041
10x10 R10B K757791
15x15 R10B K850611
20x20 R9 K835523
20x20 R10A K802006
30x30 R9 K835814
30x30 R10A K751682
30x60 R9 K767401

Gri / Grey



10x10 R10B K534900
30x30 R9 K892455

Koyu Vizon / Dark Mink

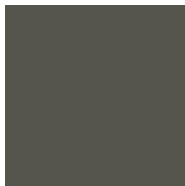

5x5 R10B K527336
10x10 R10B K527034
30x30 R10A K861326
30x30 R9 K855586

Grafit Gri / Graphite Grey



5x5 R10B K506052
10x10 R10B K767071
20x20 R9 K860033
20x20 R10A K772912
30x30 R9 835840
30x30 R10A K751704
30x60 R9 K768446
60x60 R9 K768763

Siyah / Black



5x5 R10B K508875
10x10 R10B K507371
30x30 R10A K781890

Süper Siyah / Super Black

RENKLERE GÖRE EBAT DİZİLİMİ SIZE OPTIONS IN COLOR ORDER

DOTTI



Fildeş / Ivory

5x5 R10B K505761
10x10 R10A K757780
10x10 R10B K520163
15x15 R10A K757893
15x15 R10B K823764
20x20 R9 K835324
20x20 R10A K756742
20x20 R10B K823790
30x30 R9 K835582
30x30 R10A K751623
30x60 R9 K766146
60x60 R9 K768542



Açık Bej / Light Beige

5x5 R10B K506100
20x20 R9 K835313
30x30 R9 K835626
30x30 R10A K765660



Taupe / Taupe

30x30 R9 K835630
30x30 R10A K765656



Açık Gri / Light Grey

5x5 R10B K505676
10x10 R10A K757765
10x10 R10B K520174
15x15 R10A K757871
15x15 R10B K823775
20x20 R9 K835335
20x20 R10A K754456
20x20 R10B K823801
30x30 R9 K835593
30x30 R10A K751586
30x30 R10B K823834



Taba / Tobacco

30x30 R9 K835663

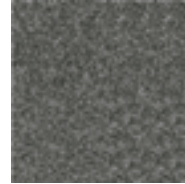

Koyu Gri / Dark Grey

5x5 R10B K505993
10x10 R10A K757776
10x10 R10B K520185
15x15 R10A K757882
15x15 R10B K823786
20x20 R9 K835346
20x20 R10A K754460
20x20 R10B K823812
30x30 R9 K835604
30x30 R10A K751601
30x30 R10B K823845

FUNCTION

COLOR DOT

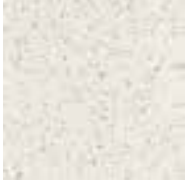

5x5 R10B K511353
30x30 R9 K835722
30x60 R9 K944657

Süper Beyaz / Super White



30x30 R10A K802426

Bej / Beige



30x30 R9 K835696
30x30 R10A K802566

Gümüş / Silver



5x5 R10B K527443

Çimento Gri / Cement Grey

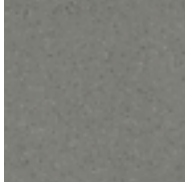

5x5 R10B K511821
10x10 R10B K511832
20x20 R10A K802625
30x30 R9 K835700
30x30 R10A K802636

Gri / Grey



10x10 R10B K527524
30x30 R10A K861282

Vizon / Mink



10x10 R10B K527513
30x30 R9 K854982

Grafit Gri / Graphite Grey



5x5 R10B K506030
10x10 R10B K764470
20x20 R9 K835420
20x20 R10A K767060
30x30 R9 K835711
30x30 R10A K757996

Antrasit / Anthracite

RENKLERE GÖRE EBAT DİZİLİMİ
SIZE OPTIONS IN COLOR ORDER

MAKSI FLAKE



30x30 R9 K943792
30x30 R10 K944189

Beyaz / White



30x30 R9 K944187
30x30 R10 K944190

Gri / Grey



30x30 R9 K944188
30x30 R10 K944191

Siyah / Black

FUNCTION

TRIMS

Duř parçası iç köře
*Shower inclined end edge
(Internal)*
M 10 x 10 cm / 4" x 4"
97 x 97 x 6.5 / 15 mm
EN14411 Bla

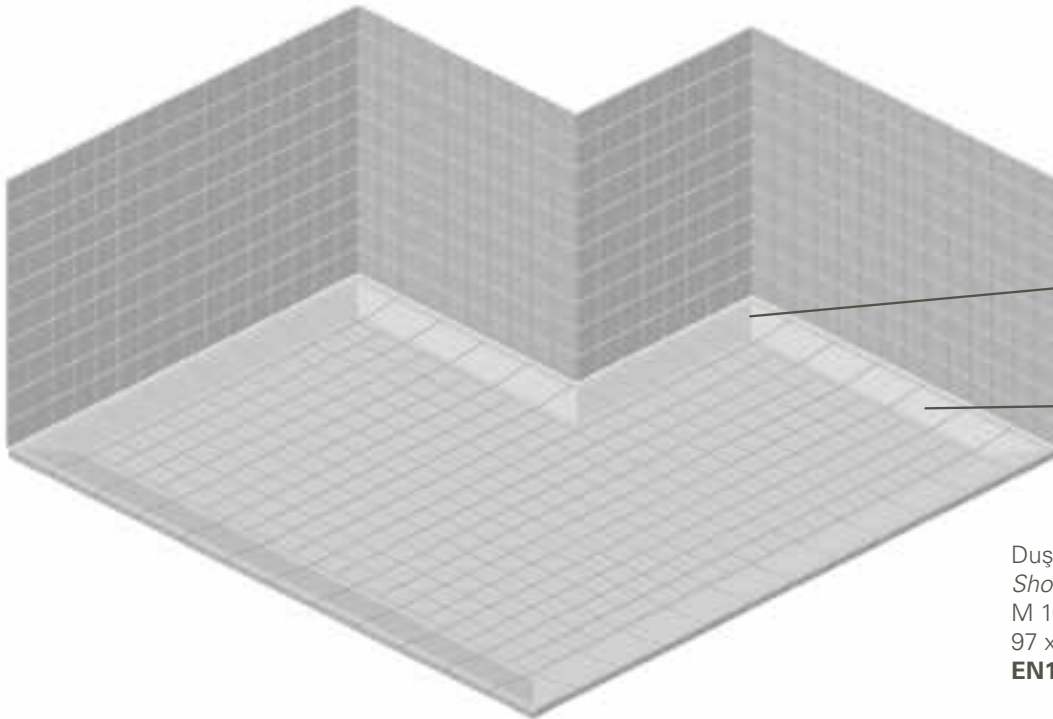

Duř parçası
Shower inclined end edge
M 10 x 10 cm / 4" x 4"
97 x 97 x 6.5 / 15 mm
EN14411 Bla

TAMAMLAYICI PARÇALAR COMPLEMENTARY PARTS

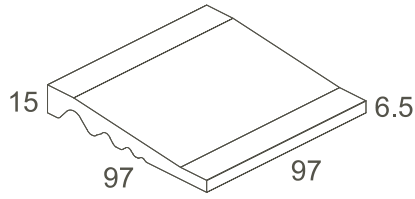

Duř parçası
Shower inclined end edge
M 10 x 10 cm / 4" x 4"
97 x 97 x 6.5 / 15 mm
EN14411 Bla

UNI

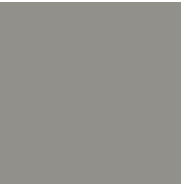

Gri / Grey
Mat / Matt K804573



Süper Siyah / Super Black
Mat / Matt K878270

DOTTI



Fildiři / Ivory
Mat / Matt K860965



Açık Gri / Light Grey
Mat / Matt K860991

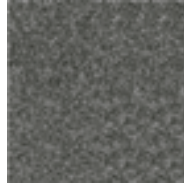

Koyu Gri / Dark Grey
Mat / Matt K861024

FUNCTION

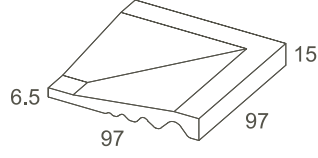

Duř parçası iç köşe
*Shower inclined end edge
(Internal)*
M 10 x 10 cm / 4" x 4"
97 x 97 x 6.5 / 15 mm
EN14411 Bla

UNI



Gri / Grey
Mat / Matt K882035

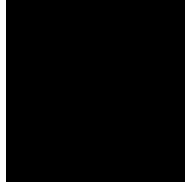

Süper Siyah / Super Black
Mat / Matt K878281

DOTTI



Fildiři / Ivory
Mat / Matt K860976



Açık Gri / Light Grey
Mat / Matt K861002

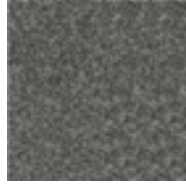

Koyu Gri / Dark Grey
Mat / Matt K861035

TAMAMLAYICI PARÇALAR COMPLEMENTARY PARTS

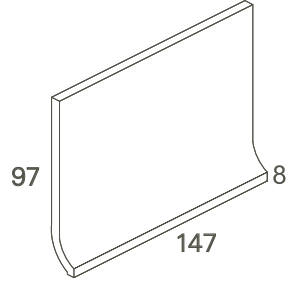

Kenar dönüş parçası
Covebase sit in
M 10 x 15 cm / 4" x 6"
8 mm
EN14411 Bla

UNI



Fildişi / Ivory
Mat / Matt K762915

DOTTI



Fildişi / Ivory
Mat / Matt K762893



Açık Gri / Light Grey
Mat / Matt K762904

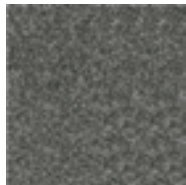

Koyu Gri / Dark Grey
Mat / Matt K793626

FUNCTION

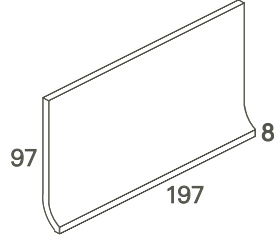

Kenar dönüş parçası
Covebase sit in
M 10 x 20 cm / 4" x 8"
8 mm
EN14411 Bla

UNI



Fildişi / Ivory
Mat / Matt K762882

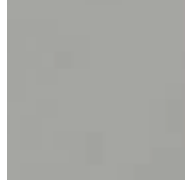

Çimento Gri / Cement Grey
Mat / Matt K861654



Gri / Grey
Mat / Matt K784805



Koyu Vizon / Dark Mink
Mat / Matt K901120

DOTTI



Fildişi / Ivory
Mat / Matt K762856



Açık Bej / Light Beige
Mat / Matt K787130



Açık Gri / Light Grey
Mat / Matt K762860

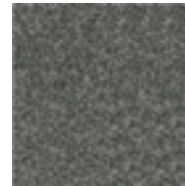

Koyu Gri / Dark Grey
Mat / Matt K762871

COLOR DOT



Gümüş / Silver
Mat / Matt K875724

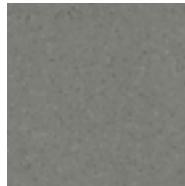

Gri / Grey
Mat / Matt K855623

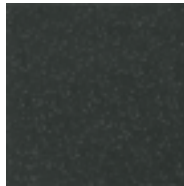

Antrasit / Anthracite
Mat / Matt K784772

TAMAMLAYICI PARÇALAR COMPLEMENTARY PARTS

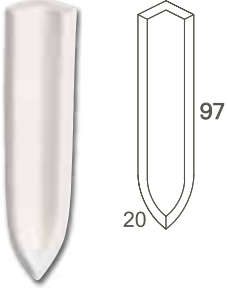

İç köşe dönüş parçası
Covebase inside corner sit in
M 2 x 10 cm / 1" x 8"
8 mm
EN14411 Bla

UNI



Fildişi / Ivory
Mat / Matt K762985

DOTTI



Fildişi / Ivory
Mat / Matt K762926



Açık Bej / Light Beige
Mat / Matt K769366



Açık Gri / Light Grey
Mat / Matt K762930

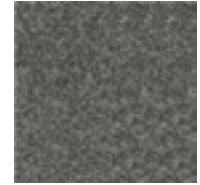

Koyu Gri / Dark Grey
Mat / Matt K762941

COLOR DOT



Bej / Beige
Mat / Matt K806773



Gri / Grey
Mat / Matt K806736

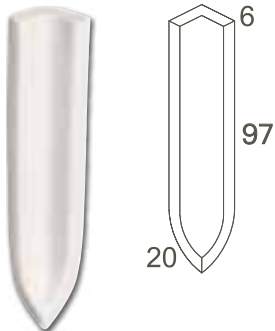

İç köşe dönüş parçası
Covebase inside corner sit in
M 2 x 10 cm / 1" x 4"
6 mm
EN14411 Bla

DOTTI



Açık Gri / Light Grey
Mat / Matt K820300

FUNCTION

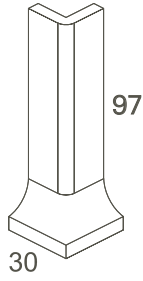

Dış köşe dönüş parçası
V cap corner sit in
M 3 x 10 cm / 1" x 4"
8 mm
EN14411 Bla

UNI



Fildişi / Ivory
Mat / Matt K762996

DOTTI



Fildişi / Ivory
Mat / Matt K762952



Açık Gri / Light Grey
Mat / Matt K762963

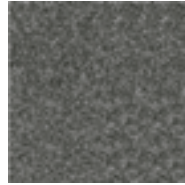

Koyu Gri / Dark Grey
Mat / Matt K762974

COLOR DOT

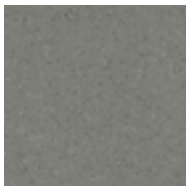

Gri / Grey
Mat / Matt K806740

TAMAMLAYICI PARÇALAR COMPLEMENTARY PARTS

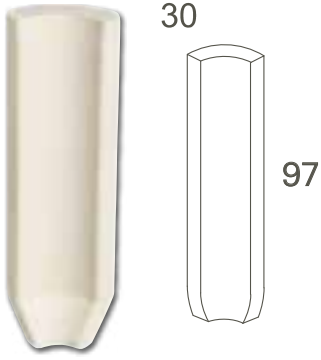

İç köşe dönüş parçası
Covebase inside corner sit on
M 3 x 10 cm / 1" x 4"
8 mm
EN14411 Bla

UNI



Fildişi / Ivory
Mat / Matt K770416



Çimento Gri / Cement Grey
Mat / Matt K861772



Gri / Grey
Mat / Matt K797946

DOTTI



Fildişi / Ivory
Mat / Matt K770405



Açık Bej / Light Beige
Mat / Matt K770803



Açık Gri / Light Grey
Mat / Matt K770420

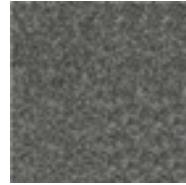

Koyu Gri / Dark Grey
Mat / Matt K770431

FUNCTION

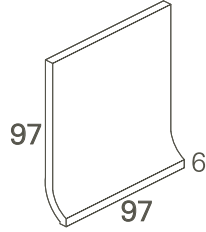

Kenar dönüş parçası
Covebase sit in
M 10 x 10 cm / 4" x 4"
6 mm
EN14411 Bla

UNI



Gri / Grey
Mat / Matt K798440



Siyah / Black
Mat / Matt K805760

DOTTI



Açık Gri / Light Grey
Mat / Matt K789975

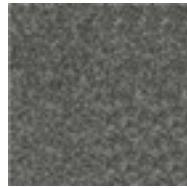

Koyu Gri / Dark Grey
Mat / Matt K791386

COLOR DOT



Gri / Grey
Mat / Matt K806725

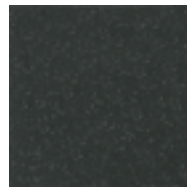

Antrasit / Anthracite
Mat / Matt K791390

TAMAMLAYICI PARÇALAR COMPLEMENTARY PARTS



Dış köşe dönüş parçası
V cap corner sit on
M 3 x 10 cm / 1" x 4"
8 mm
EN14411 Bla

UNI



Fildişi / Ivory
Mat / Matt K770453

DOTTI



Fildişi / Ivory
Mat / Matt K770442



Açık Bej / Light Beige
Mat / Matt K770851



Açık Gri / Light Grey
Mat / Matt K770464

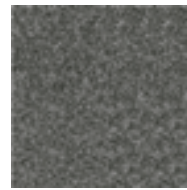

Koyu Gri / Dark Grey
Mat / Matt K770475

FUNCTION

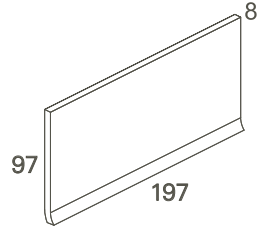

Kenar dönüş parçası
Covebase sit on
M 10 x 20 cm / 4" x 8"
8 mm
EN14411 Bla

UNI



Fildişi / Ivory
Mat / Matt K770372



Gri / Grey
Mat / Matt K860836

DOTTI



Fildişi / Ivory
Mat / Matt K770361

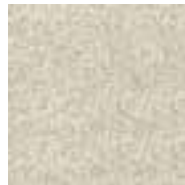

Açık Bej / Light Beige
Mat / Matt K770755



Açık Gri / Light Grey
Mat / Matt K770383

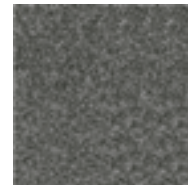

Koyu Gri / Dark Grey
Mat / Matt K770394

TAMAMLAYICI PARÇALAR COMPLEMENTARY PARTS

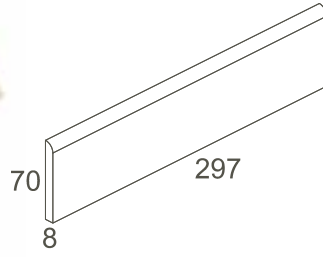

Süpürgelik
Plinth
M 7 x 30 cm / 3" x 12"
70 x 297 x 8 mm
EN14411 Bla

UNI

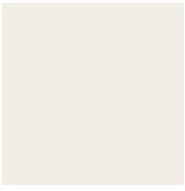

Süper Beyaz / Super White
Mat / Matt K783183

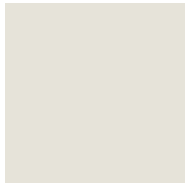

Market Beyaz /
Market White
Mat / Matt K867523



Fildişi / Ivory
Mat / Matt K752301

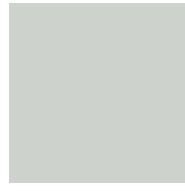

Gümüş / Silver
Mat / Matt K888756



Gri / Grey
Mat / Matt K752312

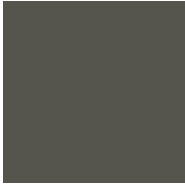

Grafit Gri / Graphite Grey
Mat / Matt K877544



Siyah / Black
Mat / Matt K752323

DOTTI



Fildişi / Ivory
Mat / Matt K752334



Açık Bej / Light Beige
Mat / Matt K766426



Açık Gri / Light Grey
Mat / Matt K752345



Koyu Gri / Dark Grey
Mat / Matt K752356

COLOR DOT



Süper Beyaz /
Super White
Mat / Matt K805992



Bej / Beige
Mat / Matt K806110



Gümüş / Silver
Mat / Matt K806235



Çimento Gri
Cement Grey
Mat / Matt K877592



Gri / Grey
Mat / Matt K806176



Vizon / Mink
Mat / Matt K877614



Grafit Gri
Graphite Grey
Mat / Matt K877603

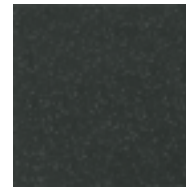

Antrasit / Anthracite
Mat / Matt K758641

FUNCTION

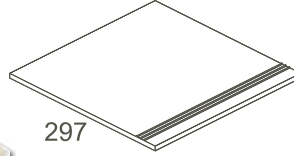

Basamak
Step
M 30 x 30 cm / 12" x 12"
297 x 297 x 8 mm
EN14411 Bla

UNI

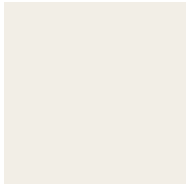

Süper Beyaz / Super White
Mat / Matt K792031



Fildişi / Ivory
Mat / Matt K754681



Gri / Grey
Mat / Matt K754692



Siyah / Black
Mat / Matt K754703

DOTTI



Fildişi / Ivory
Mat / Matt K754622



Açık Bej / Light Beige
Mat / Matt K767045



Açık Gri / Light Grey
Mat / Matt K754633

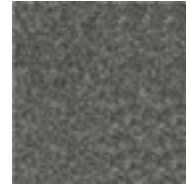

Koyu Gri / Dark Grey
Mat / Matt K754644

TAMAMLAYICI PARÇALAR COMPLEMENTARY PARTS

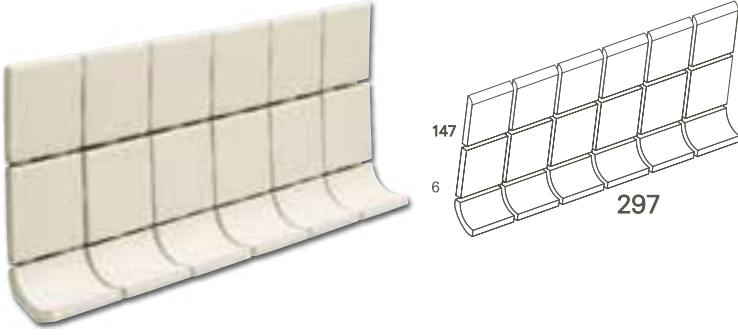

Kenar dönüş parçası
Covebase
MB 5A
M 15 x 30 cm / 6" x 12"
6 mm
EN14411 Bla

UNI



Gri / Grey
Mat / Matt K518236

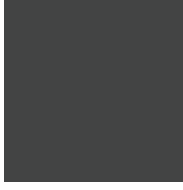

Siyah / Black
Mat / Matt K518181

DOTTI



Açık Bej / Light Beige
Mat / Matt K519743

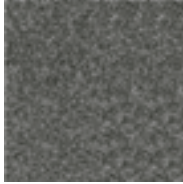

Koyu Gri / Dark Grey
Mat / Matt K518155

FUNCTION

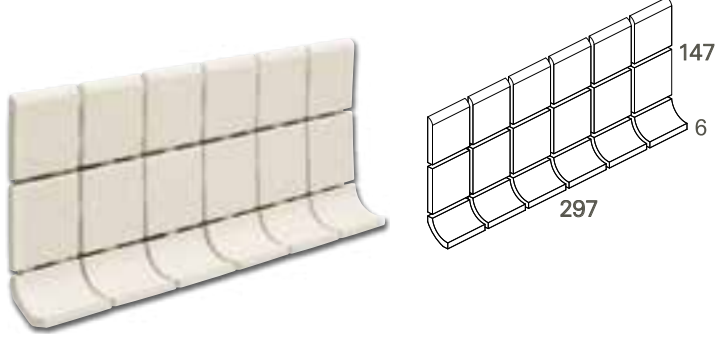

Tek kenar yuvarlak
Kenar dönüş parçası
Covebase
MB 5B
M 15 x 30 cm / 6" x 12"
6 mm
EN14411 Bla

UNI

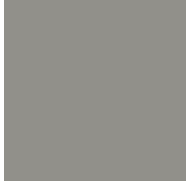

Gri / Grey
Mat / Matt K517831

DOTTI



Fildişi / Ivory
Mat / Matt K517713



Açık Bej / Light Beige
Mat / Matt K519754



Açık Gri / Light Grey
Mat / Matt K517772

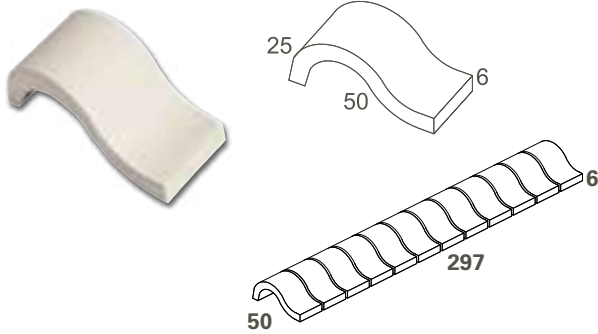

Universal trim
C 701
M 2.5 x 5 cm / 1" x 2" (Adet-Piece)
M 5 x 30 cm / 2" x 12" (Şerit-Strip)
6 mm
EN14411 Bla

UNI

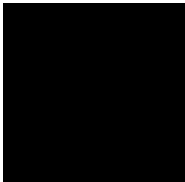

Süper Siyah / Super Black
Mat / Matt K523626SRT

TAMAMLAYICI PARÇALAR COMPLEMENTARY PARTS

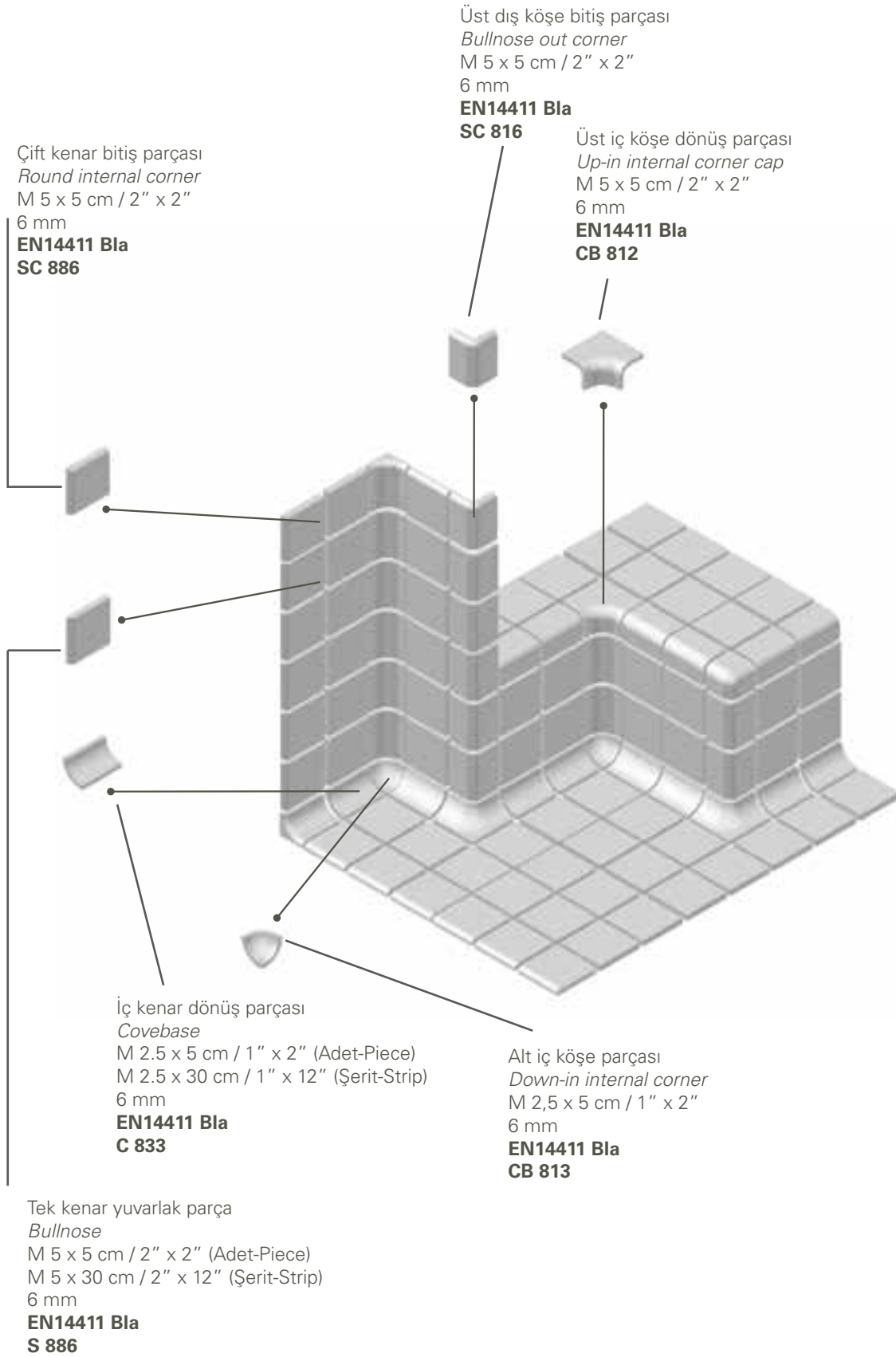

FUNCTION

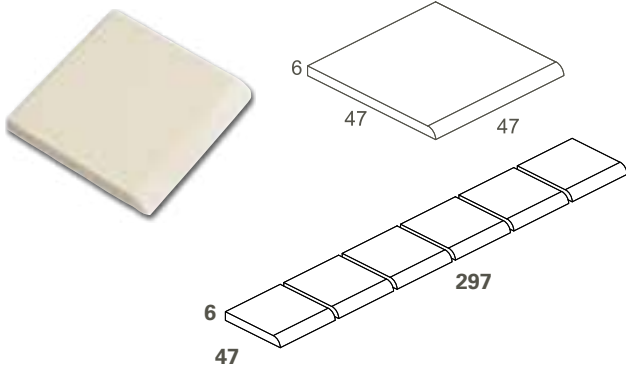

Tek kenar yuvarlak parça
Bullnose
M 5 x 5 cm / 2" x 2" (Adet-Piece)
M 5 x 30 cm / 2" x 12" (Şerit-Strip)
6 mm
EN14411 Bla
S 886

UNI

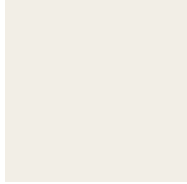

Süper Beyaz / Super White
Mat / Matt K803723SRT



Gümüş / Silver
Mat / Matt K513060SRT



Çimento Gri / Cement Grey
Mat / Matt K541907SRT



Gri / Grey
Mat / Matt K803620SRT



Siyah / Black
Mat / Matt K803524SRT

COLOR DOT



Çimento Gri
Cement Grey
Mat / Matt K541846SRT



Çift kenar bitiş parçası
Round internal corner
M 5 x 5 cm / 2" x 2"
6 mm
EN14411 Bla
SC 886

DOTTI



Açık Gri / Light Grey
Mat / Matt K513163

TAMAMLAYICI PARÇALAR COMPLEMENTARY PARTS

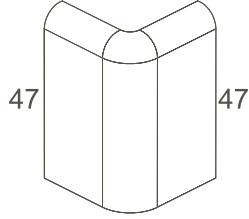

Üst dış köşe bitiş parçası
Bullnose out corner
M 5 x 5 cm / 2" x 2" - 6 mm
EN14411 Bla
SC 816

UNI

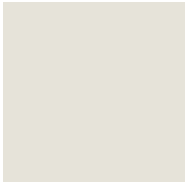

Market Beyaz / Market White
Mat / Matt K538945

DOTTI



Açık Gri / Light Grey
Mat / Matt K514180

COLOR DOT



Çimento Gri / Cement Grey
Mat / Matt K541846SRT

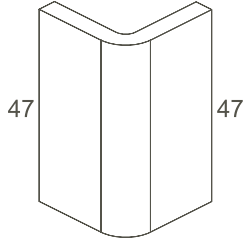

Dış kenar dönüş parçası
V Cap bullnose
M 2.5 x 5 cm / 1" x 2" (Adet-Piece) - 6 mm
M 2.5 x 30 cm / 1" x 12" (Şerit-Strip) - 6 mm
EN14411 Bla
S 832

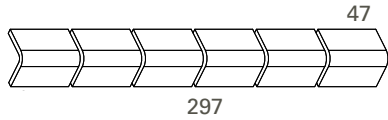

UNI

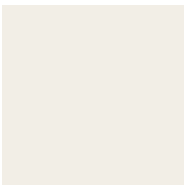

Süper Beyaz / Super White
Mat / Matt K803760SRT

FUNCTION

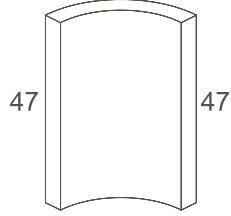

İç kenar dönüş parçası

Covebase

M 2.5 x 5 cm / 1" x 2" (Adet-Piece)

M 2.5 x 30 cm / 1" x 12" (Şerit-Strip)

6 mm

EN14411 Bla

C 833

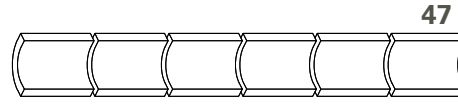

UNI



Gri / Grey
Mat / Matt K803675SRT

DOTTI

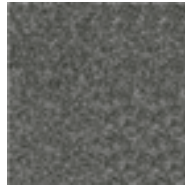

Koyu Gri / Dark Grey
Mat / Matt K754644

TAMAMLAYICI PARÇALAR COMPLEMENTARY PARTS

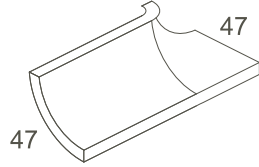

Alt sol köşe dönüş parçası
Bullnose left corner
M 2 x 5 cm / 1" x 2"
6 mm

EN14411 Bla
SCL 833

DOTTI



Açık Gri / Light Grey
Mat / Matt K513992

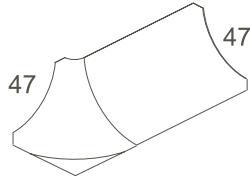

Alt sağ köşe dönüş parçası
Bullnose right corner
M 2.5 x 5 cm / 1" x 2"
6 mm

EN14411 Bla
SCR 833

DOTTI



Açık Gri / Light Grey
Mat / Matt K513804

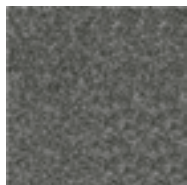

Koyu Gri / Dark Grey
Mat / Matt K513793



DISCOVER MATRIX

MATRIX'İ KEŞFEDİN

İlham veren yenilikçi Matrix koleksiyonu, dokunma hissi uyandıran benzersiz yüzey seçenekleri ve özel renk paleti ile tasarımlarınıza yeni bir derinlik kazandırıyor, size hayal ettiğiniz kombinasyonları özgürce tasarlama şansı sunuyor.

Inspiring innovative Matrix collection brings a new perspective to your designs, with unique surface options and special color pallet, giving you the chance to design the combination you dream.

Porselen Karolar / Porcelain Tiles

Bünye / Body Type

Fullbody

Yüze Alternatifleri / Surface Alternatives

Plain (R10A)

Geometric 1 (R11B)

Geometric 2 (R10B)

Random 1 (R11C)

Random 2 (R11B)

Fon Ebatları / Basic Tile Sizes

60x60 cm (R 592x592 mm)

30x60 cm (R 292x592 mm)

Fon Renkleri / Basic Tile Colors

Süper Beyaz / Super White

Nude / Nude

Taba / Tobacco

Yeşil / Green

Gri / Grey

Süper Siyah / Super Black

Kullanım Alanları / Usage Areas

Konut / Residential

Ticari Alan / Commercial

Döşeme Alanları / Tiling Areas

Yer / Floor

Duvar / Wall

Dona Dayanım / Frost Resistance

Var / Available

Desen Farklılaşması / Shade Variation Classification

V0

Ürün Standardı / Product Standard

EN14411 Group Bla

Dip Notlar / Footnotes

R

MATRIX

Vitra MATRIX, DOKUNMA HİSSİ UYANDIRAN 6 YÜZEY SEÇENEĞİ VE ÇOK ÖZEL 6 RENK ALTERNATİFİYLE YENİLİKÇİ BİR PORSELEN KARO KOLEKSİYONU SUNUYOR. MATRIX SİZİ SADE OLDUĞU KADAR SOFİSTİKE BİR ÜRÜN SİSTEMİ İLE BULUŞTURUYOR. VİTRA'NIN ÜSTÜN TASARIM VE ÜRETİM YETKİNLİĞİ İLE HAZIRLANAN YENİ YÜZEY ALTERNATİFLERİ, YENİLİKÇİ MATRIX SİSTEMİ'Nİ TAMAMLİYOR.

Vitra MATRIX OFFERS AN INNOVATIVE PORCELAIN TILE COLLECTION IN 6 SURFACE OPTIONS TEMPTING TO TOUCH AND 6 EXCLUSIVE COLOR ALTERNATIVES. MATRIX BRINGS YOU A SIMPLE BUT SOPHISTICATED PRODUCT SYSTEM. NEW SURFACE ALTERNATIVES PREPARED WITH THE SUPREME DESIGN AND PRODUCTION COMPETENCE OF VITRA CROWN THE INNOVATIVE MATRIX SYSTEM.



Porselen
Porcelain



Yer Karosu
Floor Tile



Duvar Karosu
Wall Tile



Dış Cephe
Facade



Konut
Residential



Ticari Alan
Commercial



Havuz Çevresi
Pool Surrounding



Dona Dayanım
Frost Resistance



Desen Farklılaşması
Shade Variation



Mat
Matt



Rektifiyeli
Rectified



Yeni
Novelty

MATRIX

RANDOM 1



60x60 R11C K944664R
30x60 R11C K945222R

Süper Beyaz / Super White



60x60 R11C K944652R
30x60 R11C K945212R

Nude / Nude

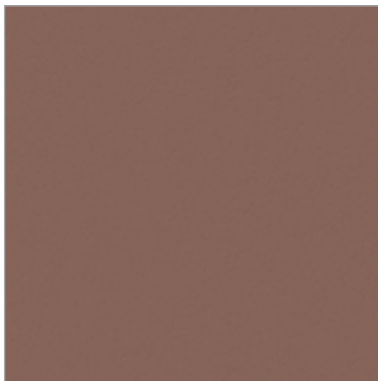

60x60 R11C K944648R
30x60 R11C K945209R

Taba / Tobacco

RENKLERE GÖRE ÜRÜN KODLARI
PRODUCT CODES IN COLOR ORDER



60x60 R11C K945035R
30x60 R11C K945199R

Yeşil / Green



60x60 R11C K946338R
30x60 R11C K946343R

Gri / Grey



60x60 R11C K944669R
30x60 R11C K945197R

Süper Siyah / Super Black

MATRIX

RANDOM 2



60x60 R11B K944665R
30x60 R11B K945223R

Süper Beyaz / Super White



60x60 R11B K944653R
30x60 R11B K945213R

Nude / Nude



60x60 R11B K944658R
30x60 R11B K945217R

Taba / Tobacco

RENKLERE GÖRE ÜRÜN KODLARI
PRODUCT CODES IN COLOR ORDER



60x60 R11B K944659R
30x60 R11B K945218R

Yeşil / Green



60x60 R11B K946339R
30x60 R11B K946344R

Gri / Grey



60x60 R11B K944670R
30x60 R11B K945198R

Süper Siyah / Super Black

MATRIX

PLAIN

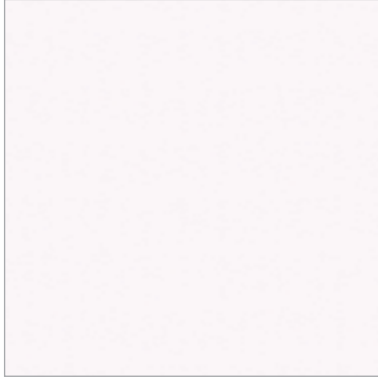

60x60 R10A K944663R
30x60 R10A K945221R

Süper Beyaz / Super White



60x60 R10A K944650R
30x60 R10A K945211R

Nude / Nude



60x60 R10A K944647R
30x60 R10A K945208R

Taba / Tobacco

RENKLERE GÖRE ÜRÜN KODLARI
PRODUCT CODES IN COLOR ORDER



60x60 R10A K944656R
30x60 R10A K945216R

Yeşil / Green



60x60 R10A K946337R
30x60 R10A K946342R

Gri / Grey



60x60 R10A K944668R
30x60 R10A K945226R

Süper Siyah / Super Black

MATRIX

GEOMETRIC 1

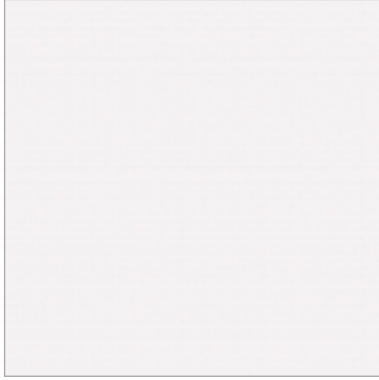

60x60 R11B K944660R
30x60 R11B K945219R

Süper Beyaz / Super White

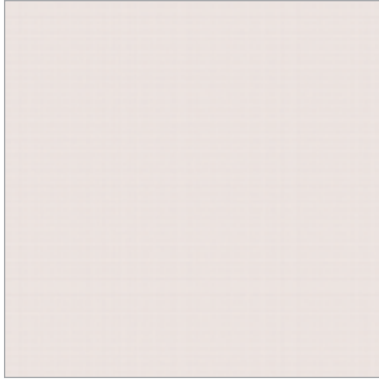

60x60 R11B K944639R
30x60 R11B K945201R

Nude / Nude

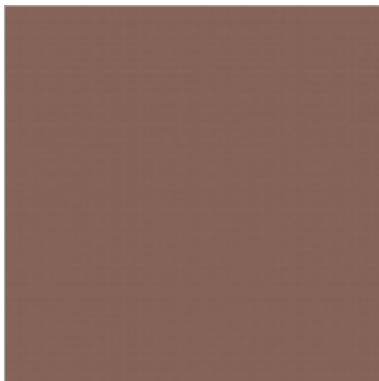

60x60 R11B K944645R
30x60 R11B K945206R

Taba / Tobacco

RENKLERE GÖRE ÜRÜN KODLARI PRODUCT CODES IN COLOR ORDER



60x60 R11B K944654R
30x60 R11B K945214R

Yeşil / Green



60x60 R11B K946335R
30x60 R11B K946340R

Gri / Grey



60x60 R11B K944666R
30x60 R11B K945224R

Süper Siyah / Super Black

MATRIX

GEOMETRIC 2



60x60 R10B K944661R
30x60 R10B K945220R

Süper Beyaz / Super White



60x60 R10B K944649R
30x60 R10B K945210R

Nude / Nude



60x60 R10B K944646R
30x60 R10B K945207R

Taba / Tobacco

RENKLERE GÖRE ÜRÜN KODLARI PRODUCT CODES IN COLOR ORDER



60x60 R10B K944655R
30x60 R10B K945215R

Yeşil / Green



60x60 R10B K946336R
30x60 R10B K946341R

Gri / Grey



60x60 R10B K944667R
30x60 R10B K945225R
R10B

Süper Siyah / Super Black



**NEW
SURFACES
WITH
MATRIX FLAKE**

MATRIX FLAKE İLE YENİ YÜZEYLER

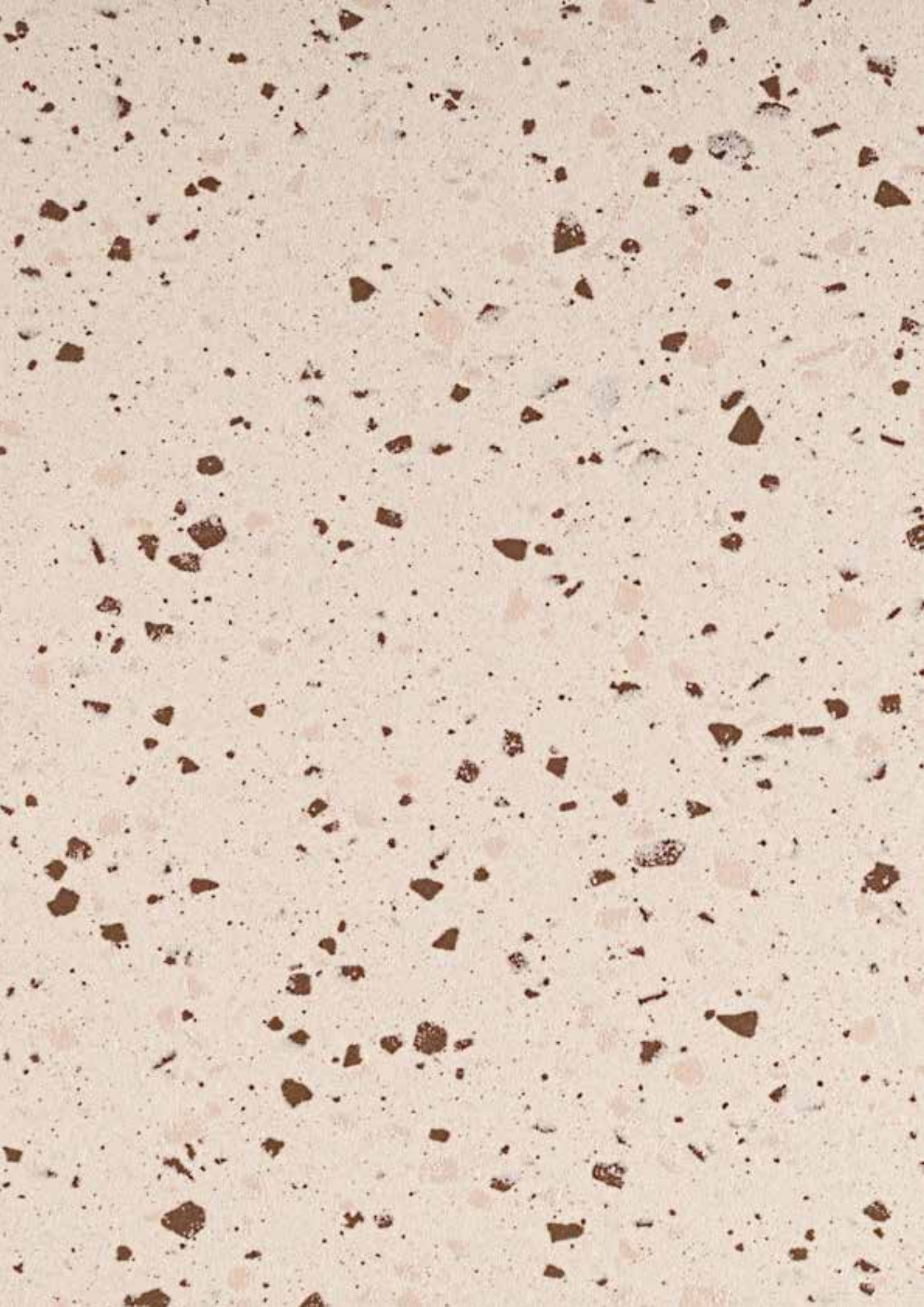

MATRIX

FLAKE

Porselen Karolar / Porcelain Tiles

Bünye / Body Type

Fullbody Porselen / Fullbody Porcelain

Yüzey Alternatifleri / Surface Alternatives

R10A

Fon Ebatları / Basic Tile Sizes

M30x30 cm (297x297 mm)

Fon ve Dekor Renkleri / Basic Tile and Decor Colors

Beyaz / White

(Nude & Taba Flake / Nude & Tobacco Flake)

Gri / Grey

(Nude & Taba Flake / Nude & Tobacco Flake)

Siyah / Black

(Beyaz & Yeşil Flake / White / Green Flake)

Kullanım Alanları / Usage Areas

Konut / Residential

Ticari Alan / Commercial

Döşeme Alanları / Tiling Areas

Yer / Floor

Duvar / Wall

Dona Dayanım / Frost Resistance

Var / Available

Desen Farklılaşması / Shade Variation Classification

V1

Ürün Standardı / Product Standard

EN14411 Group Bla

BENZERSİZ MATRIX SİSTEMİNİ ÖZEL RENKLERİ VE TANELİ FULLBODY PORSELEN YAPISIYLA TAMAMLAYAN SERAMİK SERİSİ. MİNİ TERRAZZO ETKİLİ DOKUSU İLE MATRIX KOLEKSİYONUNUN DİĞER ÜRÜNLERİ İLE UYUM İÇİNDE KULLANILIYOR VE MIX&MATCH ALTERNATİFLERİ İLE YARATICILIĞA İLHAM VERİYOR. MATRIX FLAKE, ZAMANSIZ TASARIMI VE FULLBODY PORSELEN YAPISI SAYESİNDE YÜKSEK TRAFİKLİ ALANLARDA BİLE AŞINMAYA EKSTRA DAYANIKLI ÇÖZÜMLER SUNUYOR.

A CERAMIC SERIES COMPLEMENTING THE UNIQUE MATRIX SYSTEM WITH SPECIAL COLORS AND FULLBODY PORCELAIN BODY. ITS MINI TERRAZZO TEXTURED SURFACE CAN BE USED IN HARMONY WITH OTHER PRODUCTS OF THE MATRIX COLLECTION AND INSPIRES CREATIVITY WITH MIX&MATCH ALTERNATIVES. THANKS TO ITS TIMELESS DESIGN AND FULLBODY PORCELAIN STRUCTURE, MATRIX FLAKE OFFERS EXTRA-WEAR-RESISTANT SOLUTIONS EVEN IN HIGH-TRAFFIC AREAS.



Porselen
Porcelain



Yer Karosu
Floor Tile



Duvar Karosu
Wall Tile



Dış Mekanlar
Outdoors



Havuz Çevresi
Pool Surrounding



Konut
Residential



Ticari Alan
Commercial



Dona Dayanım
Frost Resistance



Desen Farklılaşması
Shade Variation



Mat
Matt



Yeni
Novelty

FLAKE

MAKSI FLAKE



30x30 R9 K943792
30x30 R10 K944189

Beyaz / White

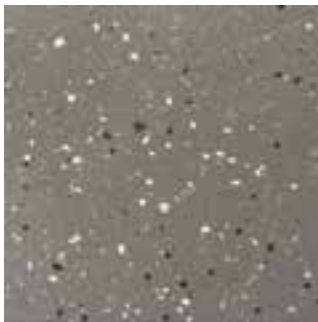

30x30 R9 K944187
30x30 R10 K944190

Gri / Grey



30x30 R9 K944188
30x30 R10 K944191

Siyah / Black

MATRIX FLAKE

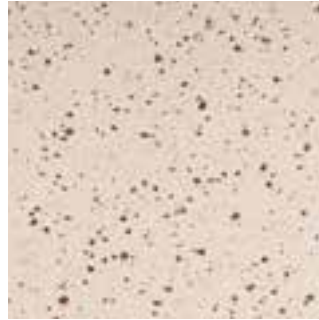

M30x30 K946397

Beyaz / White



M30x30 K946398

Gri / Grey



M30x30 K946399

Siyah / Black





SPECIAL SURFACES TILES

ÖZEL YÜZEYLİ KAROLAR



FUNCTION

Porselen Karolar / Porcelain Tiles

Bünye / Body Type
Fullbody

Yüzey Alternatifleri / Surface Alternatives

R9
R10A
Kanyon (R10)
Rondo (R10B)
Mercato (R11B)
Corund (R11B)
Resista (R11C)
Diamond (R12 V4)
Canali (R12 V10)

Fon Ebatları / Basic Tile Sizes

M15x15 cm (147x147x8 mm)
M20x20 cm (197x197x8 mm)
M20x20 cm (197x197x12 mm)
M20x20 cm (197x197x14 mm)
M30x30 cm (297x297x8 mm)
M30x30 cm (297x297x12 mm)
M30x60 cm (297x597x9 mm)
M60x60 cm (597x597x9 mm)
M60x60 cm (597x597x14 mm)

Fon Renkleri / Basic Tile Colors

Uni Fildişi / Uni Ivory
Doltti Fildişi / Dotti Ivory
Doltti Açık Bej / Dotti Light Beige
Dotti Açık Gri / Dotti Light Grey
Dotti Koyu Gri / Dotti Dark Grey
Color Dot Gri / Color Dot Grey
Color Dot Antrasit / Color Dot Anthracite

Kullanım Alanları / Usage Areas

Ticari Alan / Commercial
Endüstriyel Alan / Industrial Area

Döşeme Alanları / Tiling Areas

Yer / Floor

Dona Dayanım / Frost Resistance

Var / Available

Desen Farklılaşması / Shade Variation Classification

V0

Ürün Standardı / Product Standard

EN14411 Group Bla

ÖZEL YÜZEYLER & KALINLIK

ENDÜSTRİYEL ALANLAR İÇİN TASARLANMIŞ ÖZEL YÜZEYLİ TEKNİK PORSELEN KAROLAR

FUNCTION ÖZEL YÜZEYLERİ, YOĞUN TRAFİK VE AŞIRI YÜK ALTINDA, ENDÜSTRİYEL ALANLARDA FARKLI KAYMAZLIK VE KALINLIK DERECELERİ İLE KAYMAYA KARŞI ETKİN KORUMA SAĞLAYAN ÖZEL BİR ÜRÜN GRUBU OLARAK SUNULUYOR. GÜVENLİ DOLAŞIM VE ÇALIŞMA ORTAMLARI YARATMA OLANAĞI SUNAN TECHNIC FUNCTION, KOLAY TEMİZLENME AVANTAJIYLA FABRİKA, KESİMHANE, SÜT VE SÜT ÜRÜNLERİ, ENDÜSTRİYEL MUTFAKLAR, İŞÇİ AYAKKABISI YA DA BOTU KULLANILAN BÜTÜN MEKANLAR İÇİN İDEAL BİR ÜRÜNDÜR. FUNCTION ÖZEL YÜZEYLERİ, UNI, DOTTI, COLOR DOT VE MAKSI FLAKE ÜRÜN GRUBU ÖZELLİKLERİNİ İÇEREN 7 ÖZEL YÜZEY ALTERNATİFİYLE R9'DAN R12'YE KADAR ENDÜSTRİYEL ZEMİN KAYMAZLIĞI SINIFLARINDA ÜRETİLİYOR.

SPECIAL SURFACES & THICKNESS

TECHNIC PORCELAIN TILES WITH SPECIAL SURFACES DESIGNED FOR INDUSTRIAL AREAS

FUNCTION SPECIAL SURFACES ARE OFFERED AS A SPECIAL PRODUCT GROUP WHICH GUARANTEES EFFECTIVE ANTI-SLIP PROTECTION WITH DIFFERENT NONSLIP CLASSES IN INDUSTRIAL AREAS, UNDER HEAVY TRAFFIC AND EXCESSIVE LOAD. FUNCTION SPECIAL SURFACES OFFERING AN OPPORTUNITY TO CREATE SAFE WALKING AND WORKING ENVIRONMENTS WITH THE ADVANTAGE OF EASY CLEANING ARE IDEAL FOR FACTORIES, SLAUGHTERHOUSES, MILK AND DAIRY PLANTS, INDUSTRIAL KITCHENS AND ALL SITES WHERE WORKER SHOES OR BOOTS ARE USED. FUNCTION SPECIAL SURFACES ARE MANUFACTURED IN INDUSTRIAL ANTI-SLIP CLASSES FROM R9 TO R12, IN DIFFERENT SIZES WITH 7 SPECIAL SURFACE ALTERNATIVES IN UNI, DOTTI, COLOR DOT AND MAKSI FLAKE TEXTURES.



Porselen
Porcelain



Yer Karosu
Floor Tile



Duvar Karosu
Wall Tile



Diş Cephe
Facade



Ticari Alan
Commercial



Havuz Çevresi
Pool Surrounding



Garajlar ve Otomobil
Galerileri
Garages and Car
Showrooms



Endüstriyel Alan
Industrial Area



Diş Mekanlar
Outdoors



Dona Dayanım
Frost Resistance



Mat
Matt



Desen Farklılaşması
Shade Variation

FUNCTION

R9 - R10

RONDO
R10B

KANYON
R10

MERCATO
R11B

ÖZEL YÜZEYLER & KALINLIK - DOKULAR
SPECIAL SURFACES & THICKNESS - TEXTURES

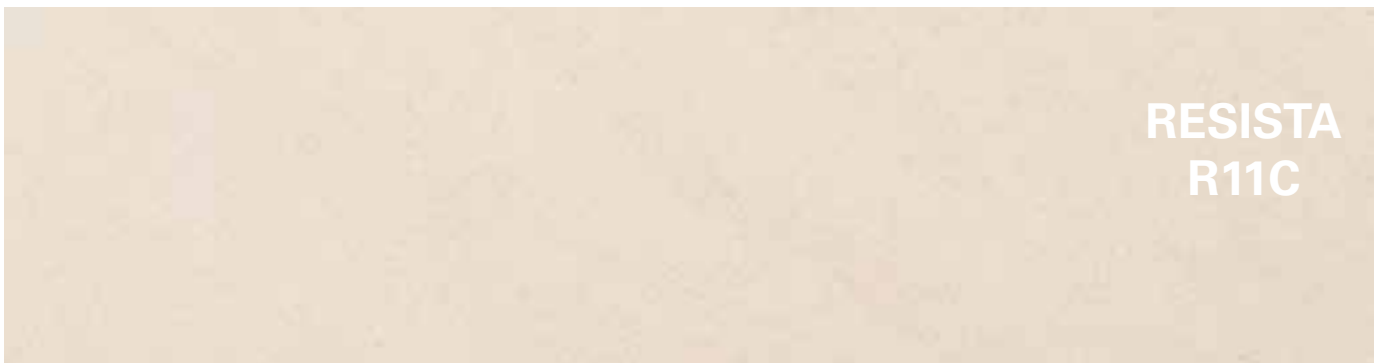

FUNCTION

UNI

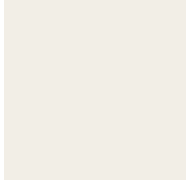

Süper Beyaz
Super White

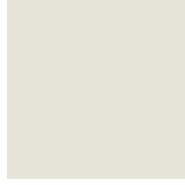

Market Beyaz
Market White

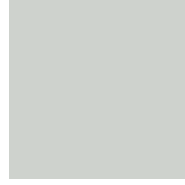

Gümüş
Silver



Fildişi
Ivory



Koyu Vizon
Dark Mink



Çimento Gri
Cement Grey



Gri
Grey

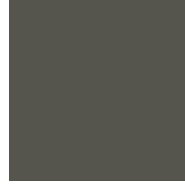

Grafit Gri
Graphite Grey



Siyah
Black

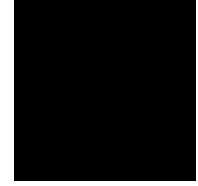

Süper Siyah
Super Black

ÖZEL YÜZEYLER & KALINLIK - RENKLER SPECIAL SURFACES & THICKNESS - TEXTURES

DOTTI



Fildişi
Ivory



Açık Bej
Light Beige



Taupe
Taupe



Açık Gri
Light Grey



Taba
Tobacco

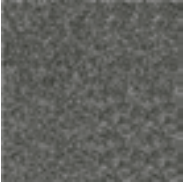

Koyu Gri
Dark Grey

COLOR DOT



Gri
Grey

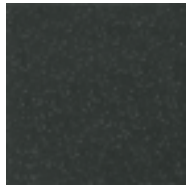

Antrasit
Anthracite

FUNCTION



Porselen
Porcelain



Yer Karosu
Floor Tile



Duvar Karosu
Wall Tile



Endüstriyel Alan
Industrial Area



Ticari Alan
Commercial



Dona Dayanım
Frost Resistance



Mat
Matt



















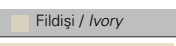
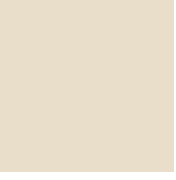
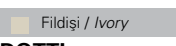
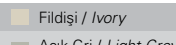

Rektifiyesiz
Non Rectified

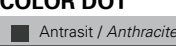
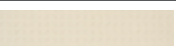
	M 15 x 15 cm 6" x 6" 147 x 147 x 8 mm	M 20 x 20 cm 8" x 8" 197 x 197 x 8 mm	M 20 x 20 cm 8" x 8" 197 x 197 x 12 mm	M 20 x 20 cm 8" x 8" 197 x 197 x 14 mm	M 30 x 30 cm 12" x 12" 297 x 297 x 8 mm	M 30 x 30 cm 12" x 12" 297 x 297 x 12 mm	M 30 x 60 cm 12" x 24" 297 x 597 x 9 mm	M 60 x 60 cm 24" x 24" 597 x 597 x 9 mm	M 60 x 60 cm 24" x 24" 592 x 592 x 14 mm
R9									
UNI									
	K835184	K835501			K835803		K766986	K768704	K944193
DOTTI									
		K835324			K835582	K836750	K766146	K768542	K944195
		K835335	K757986		K835593		K766124		
R10A									
UNI									
		K758744	K758652	K761703	K751645				
DOTTI									
	K757893	K756742	K757801	K761165	K751623	K825131			
	K757871	K754456	K864152	K761176	K751586	K825142			
	K757882	K754460	K864163	K761692	K751601				
KANYON									
UNI									
					K779074				
DOTTI									
		K756775			K757103				
					K757092				
		K756764			K757081				

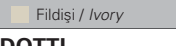
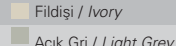
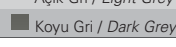
EBATLARA GÖRE RENK DİZİLİMİ

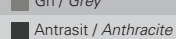
COLOR OPTIONS IN SIZE ORDER

									
	M 15 x 15 cm 6" x 6" 147 x 147 x 8 mm	M 20 x 20 cm 8" x 8" 197 x 197 x 8 mm	M 20 x 20 cm 8" x 8" 197 x 197 x 12 mm	M 20 x 20 cm 8" x 8" 197 x 197 x 14 mm	M 30 x 30 cm 12" x 12" 297 x 297 x 8 mm	M 30 x 30 cm 12" x 12" 297 x 297 x 12 mm	M 30 x 60 cm 12" x 24" 297 x 597 x 9 mm	M 60 x 60 cm 24" x 24" 597 x 597 x 9 mm	M 60 x 60 cm 24" x 24" 592 x 592 x 14 mm
									
RONDO									
UNI									
					K791202				
									
MERCATO									
UNI									
				K761681	K791224				
DOTTI									
		K781406	K781432		K781466				
	K823930	K781384	K781410	K761666	K781443	K897112			
		K781395	K781421		K781454				
		K932110			K932106				
COLOR DOT									
					K885260				
									
CORUND									
UNI									
			K758674						
DOTTI									
		K757916			K791121				
	K757845	K757894	K758696		K791106				
		K757905	K758711		K791110				
COLOR DOT									
		K877496							
		K809475							

FUNCTION



Porselen
Porcelain



Yer Karosu
Floor Tile



Duvar Karosu
Wall Tile



Endüstriyel Alan
Industrial Area



Ticari Alan
Commercial



Dona Dayanım
Frost Resistance



Mat
Matt



Rektifiyesiz
Non Rectified



M 15 x 15 cm
6" x 6"
147 x 147 x 8 mm

M 20 x 20 cm
8" x 8"
197 x 197 x 8 mm

M 20 x 20 cm
8" x 8"
197 x 197 x 12 mm

M 20 x 20 cm
8" x 8"
197 x 197 x 14 mm

M 30 x 30 cm
12" x 12"
297 x 297 x 8 mm

M 30 x 30 cm
12" x 12"
297 x 297 x 12 mm

M 30 x 60 cm
12" x 24"
297 x 597 x 9 mm

M 60 x 60 cm
24" x 24"
597 x 597 x 9 mm

M 60 x 60 cm
24" x 24"
592 x 592 x 14 mm



RESISTA R11C

UNI

Fildişi / Ivory

K944196

DOTTI

Fildişi / Ivory

K946237

K944197

Açık Gri / Light Grey

K946471

Koyu Gri / Dark Grey

K946472



DIAMOND

UNI

Fildişi / Ivory

K758092

K758663

DOTTI

Fildişi / Ivory

K757834

K757942

K758722

Açık Gri / Light Grey

K757812

K757920

K758685

Koyu Gri / Dark Grey

K857104

K757931

COLOR DOT

Gri / Grey

K855612

Antrasit / Anthracite

K877485



CANALI

DOTTI

Fildişi / Ivory

K761585

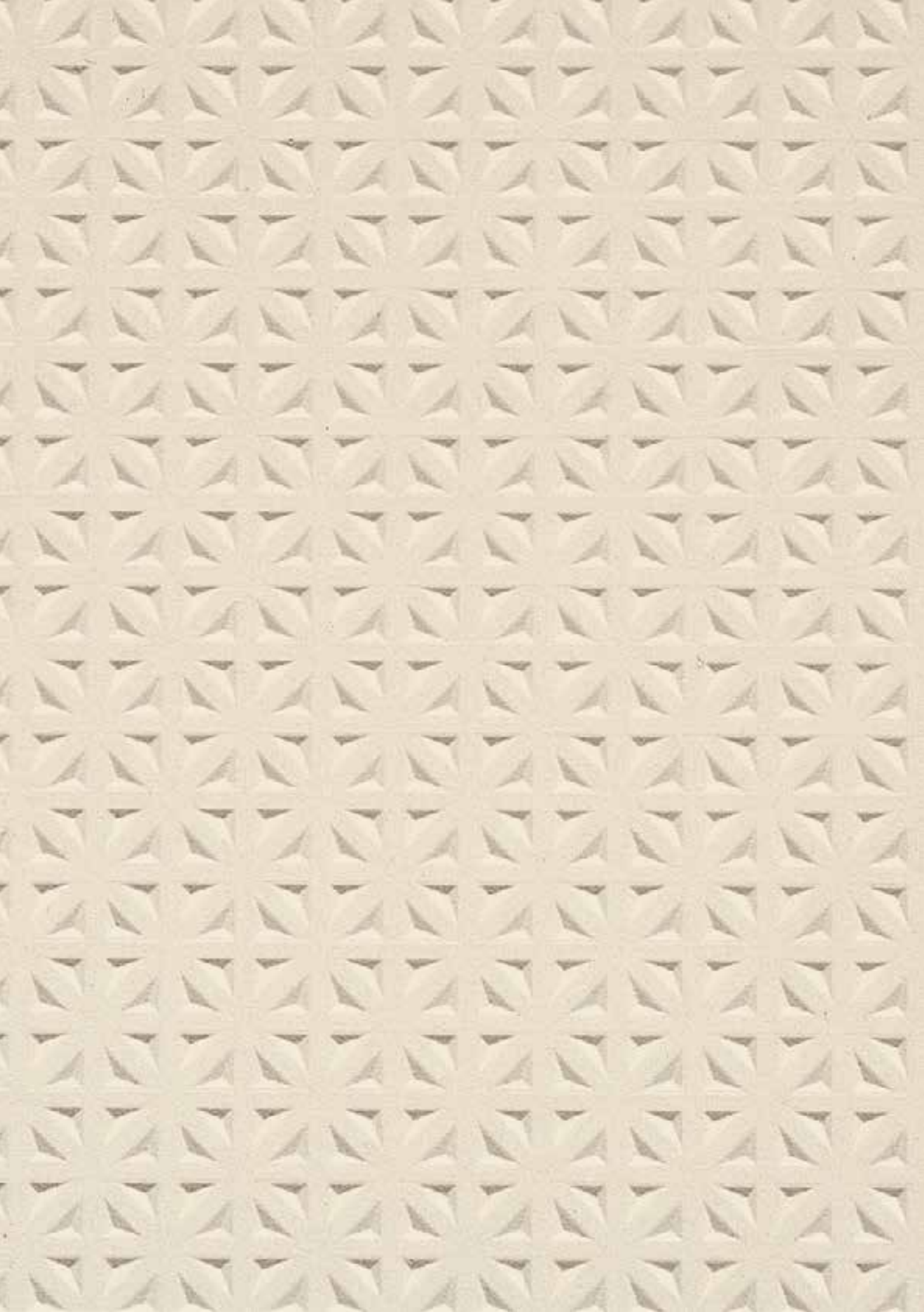

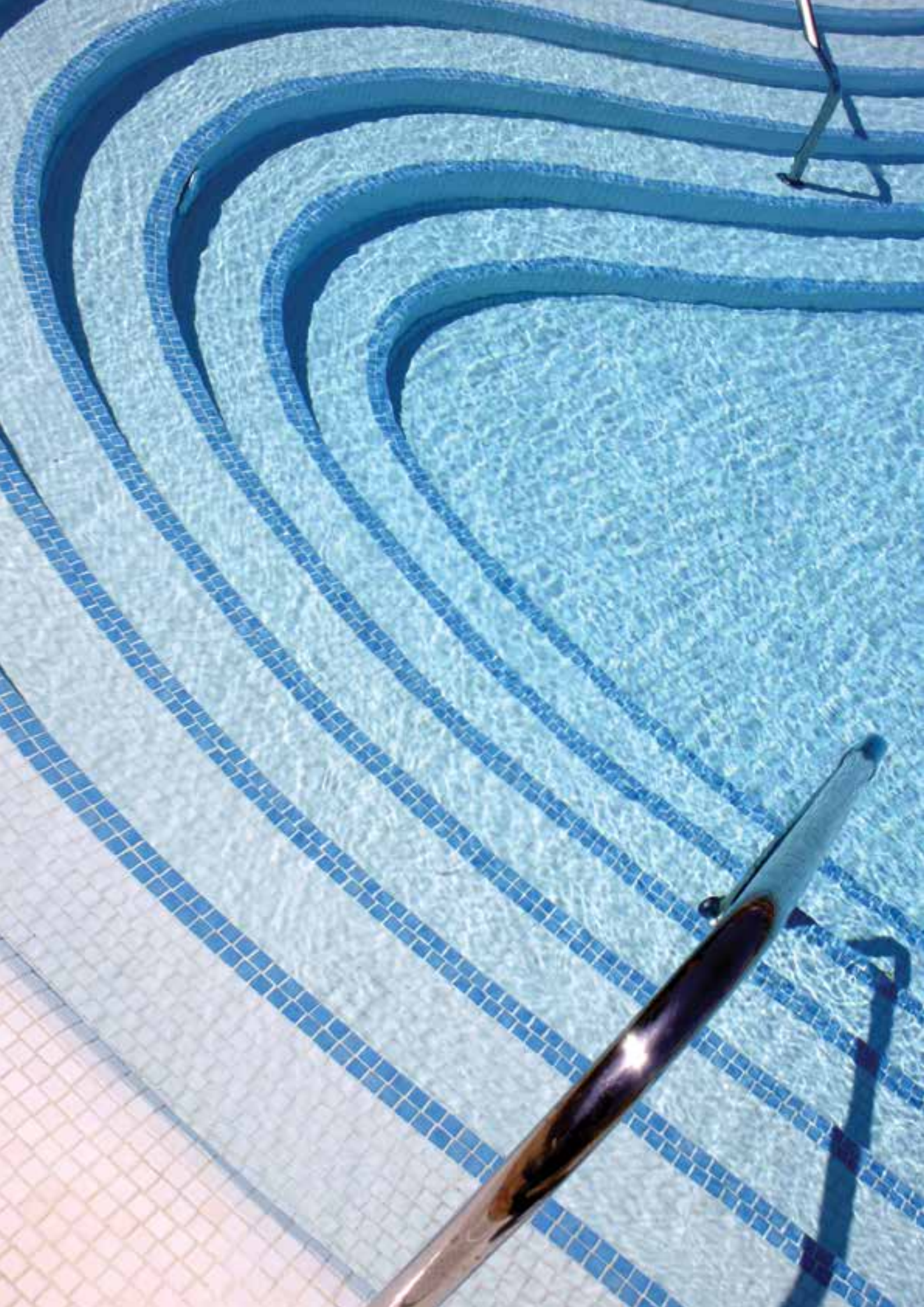

PROJECT SERVICES

PROJE HİZMETLERİ

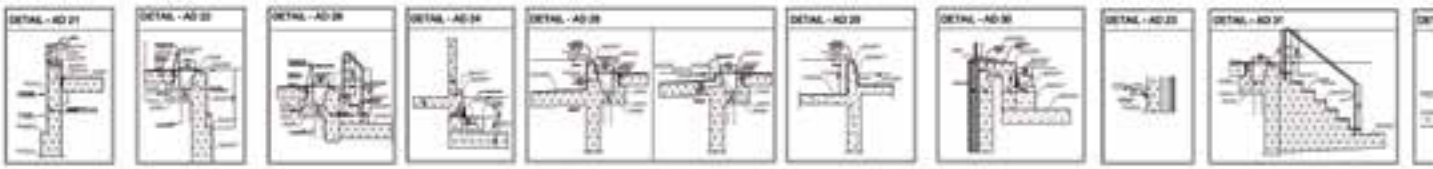
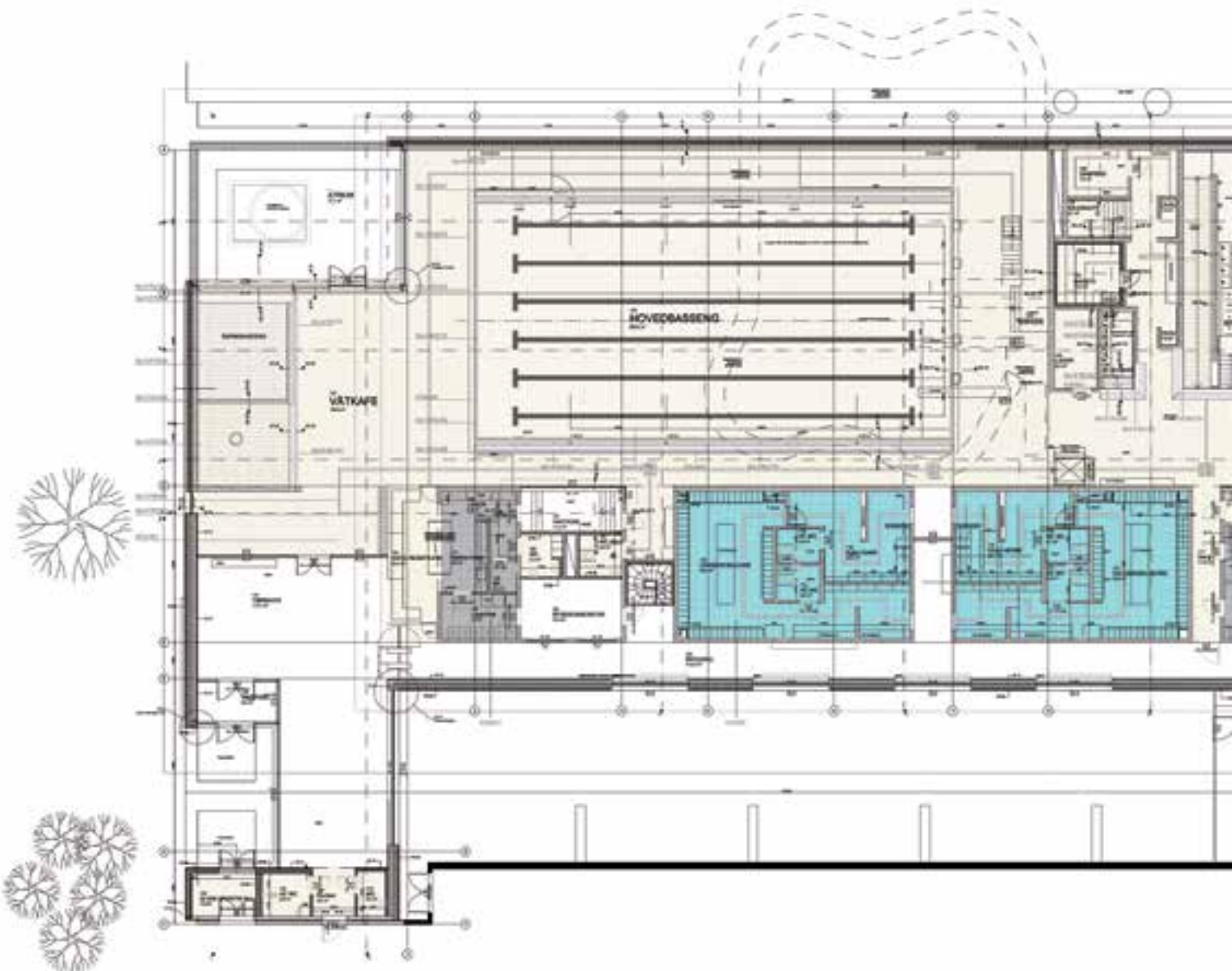

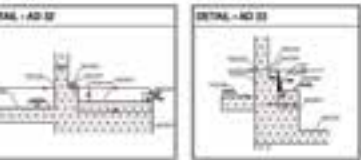
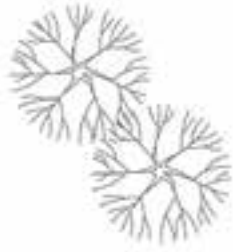

VitrA'DAN PROJELERİNİZE ÖZEL YARATICI ÇÖZÜMLER

İstenilen havuz projesinin mimari plan ve kesitleri VitrA'ya ulaştırıldığı takdirde, deneyimli VitrA uzmanları ücretsiz destek sağlıyor: Havuz karolaj planlarının çizimi, ürün metrajlarının temini gibi hizmetlere ek olarak, havuzun tankı ve çevresi, soyunma odaları, duşlar ve havuz kompleksine ait tüm unsurları kapsayan bütünsel danışmanlık hizmetinden faydalanmak için satış temsilcilerimizle iletişime geçebilirsiniz.

VitrA'S CREATIVE SOLUTIONS SPECIAL FOR YOUR PROJECTS

In the event architectural plan and sections of any desired pool projects are delivered to VitrA, the team of qualified VitrA specialists provide cost free support: You can contact our sales representatives for a holistic consulting service including all elements of pool tank and surrounds, changing rooms, shower rooms and pool complex in addition to other services, such as drawing of pool tiling layout plans, provision of product quantities etc.



REFERENCES

REFERANSLAR



Jersey Waterfront, GREAT BRITAIN
Queen Mary II Transatlantic, FRANCE



Aquapolis, UKRAINE
Schloßbad Wickrath, GERMANY





Etterbeek Swimming Pool Center, GERMANY
Stadt Plauen, GERMANY



Magic Life, Bodrum Imperial, TURKEY
Sungate Port Royal, Antalya, TURKEY



Dulwich College, ENGLAND
Scotland Stirling University, ENGLAND



Jersey Waterfront College, ENGLAND
Westfalenbad Hagen, GERMANY

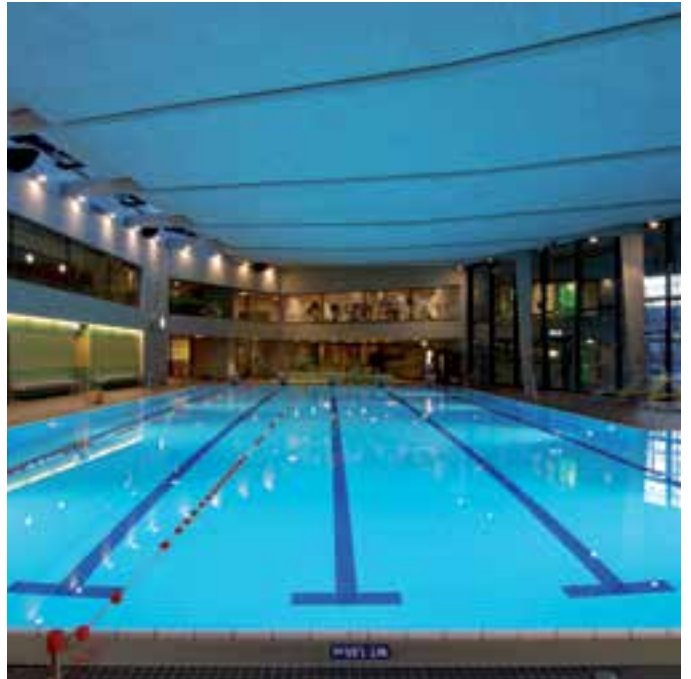

Stadt Plauen, GERMANY
Kombibad – Ossendorf, GERMANY



Soria Moria Hotel, Oslo, NORWAY
Ringeriksbadet, Oslo, NORWAY

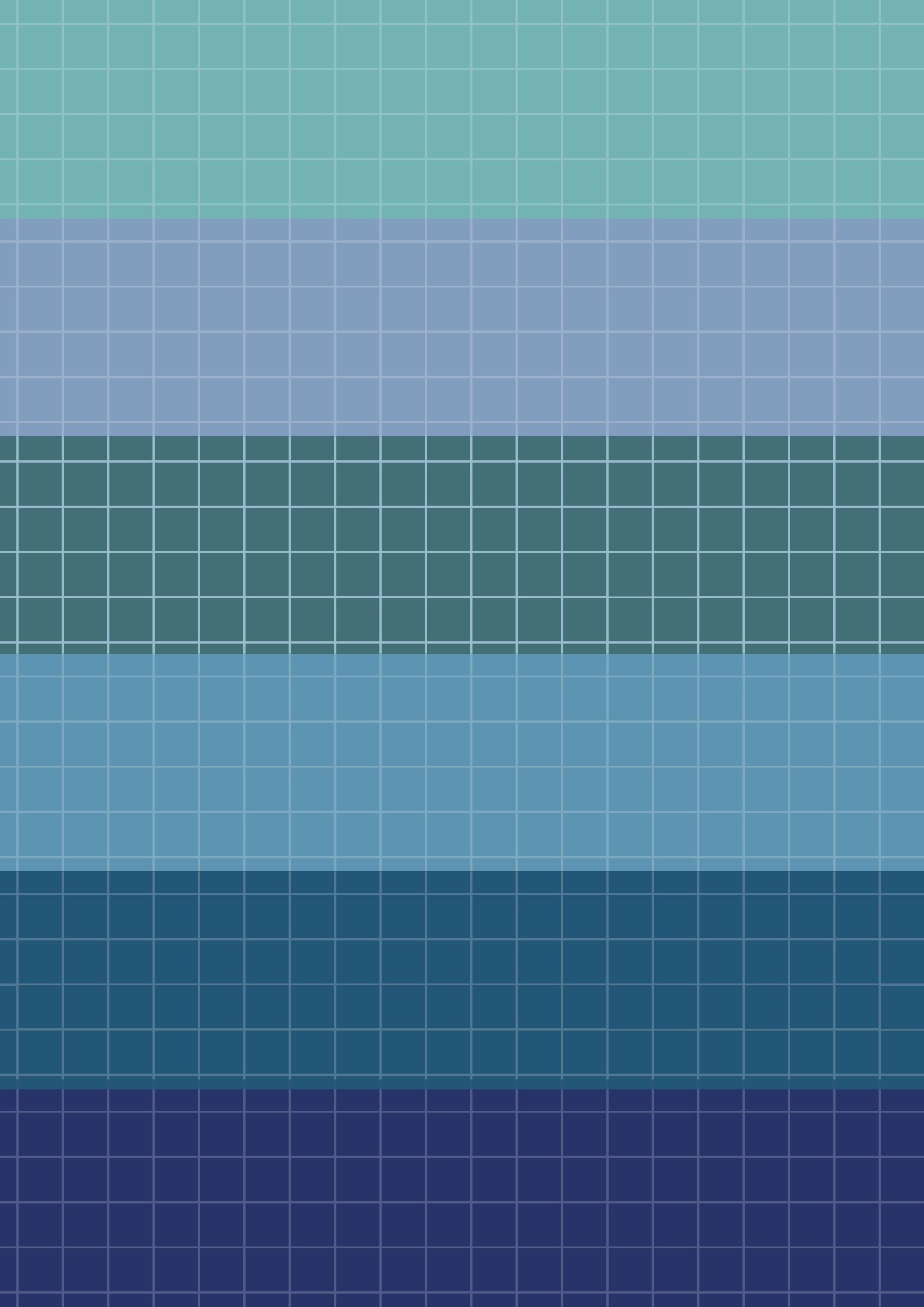

TECHNICAL INFORMATION

TEKNİK BİLGİLER





VitrA PHOTOACTIVE

Nano boyutlu titanyum dioksit (TiO₂) kaplı fotokatalitik özellikleri sayesinde kendi kendini temizleyen VitrA Photoactive karolar, aynı zamanda havadaki kirlilikleri ve kötü kokuları yok eder.

Işık ve havadaki nem ile aktive olduğu için özellikle dış cephe kullanımında ideal olan VitrA Photoactive, üstün teknolojisi ile yüzeyine gelen kirlilikleri parçalayarak yok eder. Ayrıca havadaki kirliliklerin ve kokuların temizlenmesine yardımcı olur.

* Tüm ürünlerine uygulanabilir.

Self-cleaning VitrA Photoactive tiles are coated with nano-sized titanium dioxide (TiO₂). Thanks to their photocatalytic properties, VitrA Photoactive tiles are self-cleaning and the coating also eliminates air pollutants and unpleasant odors.

VitrA Photoactive tiles are especially ideal for external cladding since they are activated by light and humidity in the air. Hi-tech VitrA Photoactive tiles eliminate the pollutants on their surface by decomposing them. They help cleaning air pollutants and odors in the air as well.

* Can be applied to all products.

Kendi kendini temizleyen ve kolay temizlenen karolar

VitrA Photoactive karolar, kendi kendini temizleme özelliği sayesinde, özellikle dış cephe temizliklerinde gereken enerji, su, kimyasal temizlik malzemesi ve insan gücünden tasarruf sağlar.

Self-cleaning and easy to clean tiles

Self-cleaning VitrA Photoactive tiles significantly reduce the amounts of water, power, chemical cleaning agents and labor required to clean building facades in particular.

Hidrofilik 'suyu seven' yüzey

Yüzeyle gelen su veya yağmur ile toz ve diğer kirler yüzeyden kolayca akar.

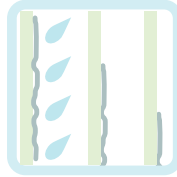

Hydrophilic 'water loving' surface

Dust or other dirt particles on the surface are easily washed away by rain or water.

Fotokatalitik etki

Yüzeyle gelen organik kirlilikler parçalanarak yok olur.

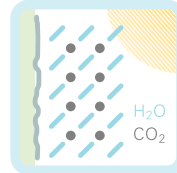

Photocatalytic action

It eliminates the organic pollutants upon contact by decomposition.

Koku giderici etki

Havada kirlilik yaratan azot ve sülfür oksit gibi maddelerin, sigara kokularının ve hastanelerde yoğun olan ilaç kokusunun giderilmesi için ideal bir çözümdür.



Odor eliminating action

It is a perfect solution to air pollutants such as nitrogen oxides and sulfur oxides, cigarette smoke, as well as the smell of disinfectant and other hospital odors.

VitrA CLEAN

VitrA Clean, VitrA'nın karo ve ıslak mekân ürünlerini daha kolay temizlenebilir kılan modern bir yüzey zenginleştirme yöntemidir. Özel sırlama yöntemi yüzey gerilimini artırır. Böylece su, yüzey üzerinde cıva gibi hareket ederek kirin kolaylıkla yüzeyden ayrılmasını sağlar. Ürün yüzeyleri sadece suyla, nemli bir bezle veya gerektiği takdirde yumuşak temizleme maddeleriyle temizlenebilir. Bu kalıcı özellik hem profesyonel, hem de özel kullanım alanlarının temizliğinde kullanıcılara büyük kolaylıklar sağlamaktadır. VitrA Clean, istek üzerine PRO TECHNIC koleksiyonu içindeki Color serisi duvar karolarına da uygulanabilir.

* Duvarda kullanılacak tüm PRO Color ürünlerine uygulanabilir.

VitrA Clean is a surface finish that makes VitrA tiles and sanitaryware products incredibly easy to care for. This special glazing process increases surface tension, meaning water and soil flows easily from the surface. All that's needed to keep surfaces clean is a wipe with a damp cloth and the use of a mild cleanser, providing long-term time savings, both in residential and commercial environments. (VitrA Clean is available as an option on Color series from PRO TECHNIC range wall tiles.)

* Can be applied to all PRO Color wall tiles.

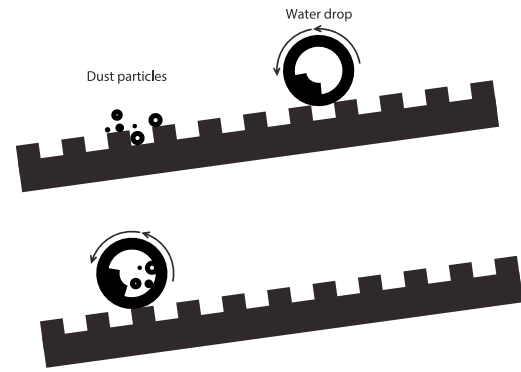

VitrA HYGIENE

VitrA Hijyen

VitrA Hijyen sağlık açısından fayda sağlayan bir teknolojidir. Bu yöntemle geliştirilmiş yüzeylerde maksimum hijyen sağlanmaktadır. VitrA Hijyen yoğun kullanım altında dahi koruma özelliğini kaybetmemektedir. Bu özel sır, dünya çapında tarafsız araştırma enstitüleri tarafından test edilmiş ve onaylanmıştır. VitrA Hijyen, opsiyonel olarak PRO TECHNIC koleksiyonu içindeki Color serisine ve Pool serisine ait karolara da uygulanabilir.

* Tüm PRO Color ürünlerine uygulanabilir.

VitrA Hygiene

VitrA Hygiene is a technology which offers benefits in terms of health. Maximum hygiene is ensured on the surfaces developed with this method. VitrA Hygiene does not lose its protection feature even under intense usage conditions. This special glaze is tested and approved by worldwide impartial research institutes. VitrA Hygiene may be applied on the tiles of Color series from PRO TECHNIC range and Pool series optionally.

* Can be applied to all PRO Color products.

Normal
Ceramic Surface

VitrA
Hygiene

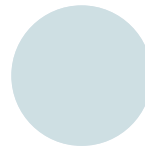
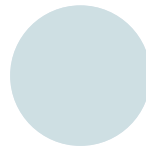

Test öncesi seramik yüzeyler
Ceramic surfaces before test

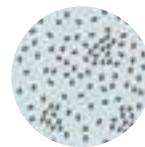
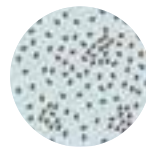

Eşit derecede kirli olan test yüzeyleri
Equally dirty test surfaces

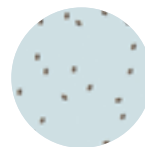
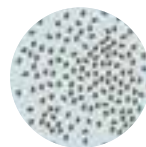

12 saat sonra
After 12 hours

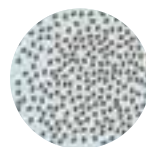

24 saat sonra
After 24 hours

FİLELEME MESH MOUNTING

Fileleme

Özellikle ıslak mekânlar için küçük ebatlı karolar 297 x 297 mm ebadında levhalar oluşturacak şekilde filelenir. Geleneksel kağıt ve naylon filenin yanı sıra yeni bir teknoloji ile üretilen "dot mounting" fileleme yöntemi ayrıca isteğe bağlı olarak önden kağıt ve naylon fileleme de uygulanabilir.

"Dot Mounting" seçeneğinde karolar polyester katkılı bir malzeme ile noktalar halinde birleştirilir; bu sayede fileli karolar hem dış mekânda hem de ıslak ortamlarda rahatlıkla kullanılabilir.

Dot Mounting, kağıt ve naylon filenin avantajları:

- Basit, hızlı döşeme
- Mozaiklerin daha kolay tasarlanması
- Renk kombinasyonları

Dot Mounting'in kağıt ve naylon fileye göre avantajları:

- Sudan etkilenmez
- Yüksek yapışma mukavemeti
- Tam ölçüsünde derz kesimi

Islak alanlar için üstten file ve dot mount file uygulaması önerilir.

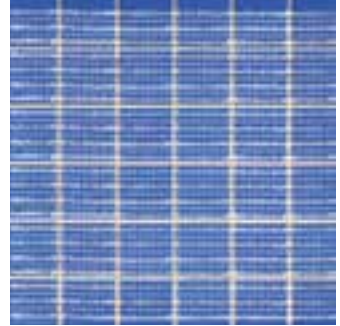
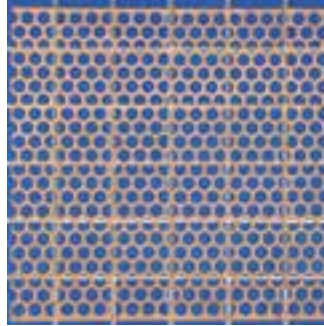
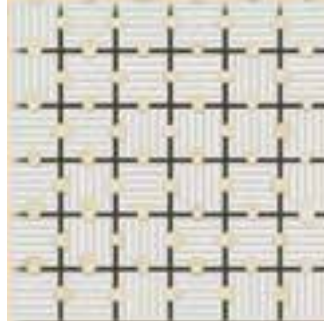

Mesh mountings

For simpler and faster laying, easier mosaic creation, color combinations and the special requirements of wet areas, tiles can be

pre-glued at the factory to make easy-to-laid 297 x 297 mm tile mats of small format tiles. In addition to traditional plastic and paper mesh mounting, VitrA's innovative new dot mounting method fixes tiles together at the sides with dots of adhesive. Dot mounted tiling is unaffected by water and remains firm even in the most demanding environments – its advantages are superior water resistance, improved bonding with underlying surfaces, and precise joints.

Benefits of dot mounting, paper mesh and plastic mesh mounting:

- More simple and faster to lay
- Easier to create mosaics
- Color combinations

Advantages of dot mounting compared to paper mesh and plastic mesh methods:

- Water resistant
- Improved bonding with the underlying surface
- Precise joints

Top net or dot mount net application is recommended for wet spaces





PRO POOL SOLUTIONS

Vitra PROTECT

VİTRA ÖZEL OLARAK PARLATILMIŞ PORSELEN KAROLAR İÇİN, VİTRA PROTECT TEKNOLOJİSİNİ GELİŞTİRDİ. ÜRETİMDEN ÇIKAN PARLAK PORSELEN KAROLARIN YÜZEYİNE YAPILAN BİR UYGULAMA İLE TAŞLAMA ESNASINDA ORTAYA ÇIKAN BOŞLUKLAR DOLDURULURKEN, HEM KİR VE LEKELERİN YÜZEYE YERLEŞMESİ ENGELLENİR HEM DE KAROLARIN PARLAKLIĞI KORUNUR.

Vitra PROTECT

THE VITRA PROTECT PROCESS IS AN ADDITIONAL TREATMENT CARRIED OUT AT THE MANUFACTURING STAGE FOR POLISHED PORCELAIN TILES. ELIMINATING THE NEED FOR TIME-CONSUMING ANTI-STAINING TREATMENTS AT THE LAYING STAGE, THIS INNOVATIVE TREATMENT SEALS THE TINY MICROPORES OF POLISHED TILES, MAKING IT IMPOSSIBLE FOR DIRT TO PENETRATE – ALL WITHOUT AFFECTING A TILE'S BEAUTIFULLY POLISHED APPEARANCE.

KAYMAZLIK DEĞERLERİ SINIFLANDIRMASI

CLASSIFICATION OF ANTI-SLIP VALUES

a) Islak alanda kayma sınıfları ve kullanım alanları

Değerlendirme grubu	Asgari eğim açısı	Sahalar
A	12°	Çıplak ayakla basılan yerler (büyük ölçüde kuru) Tek ve toplu soyunma odaları Yüzme bilmeyenler sahasında havuz zeminleri, eğer tüm saha içinde su derinliği 80 cm'den fazlaysa Sauna ve dinlenme alanları (büyük ölçüde kuru)
B	18°	Çıplak ayakla basılan yerler, A'ya dahil değilse eğer Duş odaları Dezenfeksiyon püskürtme sistemleri sahası Havuz kenarları Yüzme bilmeyenler sahasında havuz zeminleri, eğer kısmi sahalar içinde su derinliği 80 cm'den az ise Dalgalı havuzlarda yüzme bilmeyenler sahasında havuz zeminleri Ayarlanabilen zeminler Çocuk havuzları Suya inen merdivenler Suya inen, maksimum 1 m genişliğinde iki yanında tutma yeri olan merdivenler Havuz sahası dışındaki merdivenler ve basamaklar Sauna ve dinlenme sahaları, A'ya dahil değilse eğer
C	24°	Suya inen merdivenler, B'ye dahil değilse eğer Geçiş havuzları Eğimli havuz kenarı oluşumları

A'dan C'ye artan bir derecelendirme ile farklı kayma tehlikeleri için A, B ve C sınıfları oluşturulmuştur. Tabloda kayma sınıflarının en düşük açıları belirtilmiştir. Bu açıları EN 51097'ye göre yer kaplamalarının sağlaması gerekmektedir. Islak kayma sınıfları listesi, her alanı içermeyebilir.

a) Wet barefoot areas slip resistance classification and application areas

Class	Min. degree of slope	Areas
A	12°	Barefoot hallways (mostly dry) Individual and group changing rooms Bottom of the non-swimmer sections when the water depth is more than 80 cm Sauna and rest areas
B	18°	Barefoot hallways and passages not answering the class A description Shower rooms Areas surrounding disinfectant sprayers Pool surrounds Bottom of the non-swimmer sections when the water depth is less than 80 cm Floors of non-swimmer sections in tide-effect pools Adjustable swimming pool floors Lift-slab floors Pool-access ladders Pool-access steps/stairs with a max. width of 1 m and handrails on both sides Ladders and steps/stairs outside of the pool areas Sauna and rest areas not answering the class A description
C	24°	Pool-access steps/stairs not answering the class B description Walk-through pools Inclined pool borders

According to the slip resistance classification system, classes A, B and C are defined for the wet barefoot areas, with A being the lowest and C the highest slip resistance. The table shows the minimum degrees of surface slipness. The surfaces are tested according to EN 51097. The list of the wet barefoot areas is not exhaustive.

b) Endüstriyel alanda kayma sınıfları ve dolma hacmi
Industrial areas slip resistance classes and collection space

Kayma sınıfları

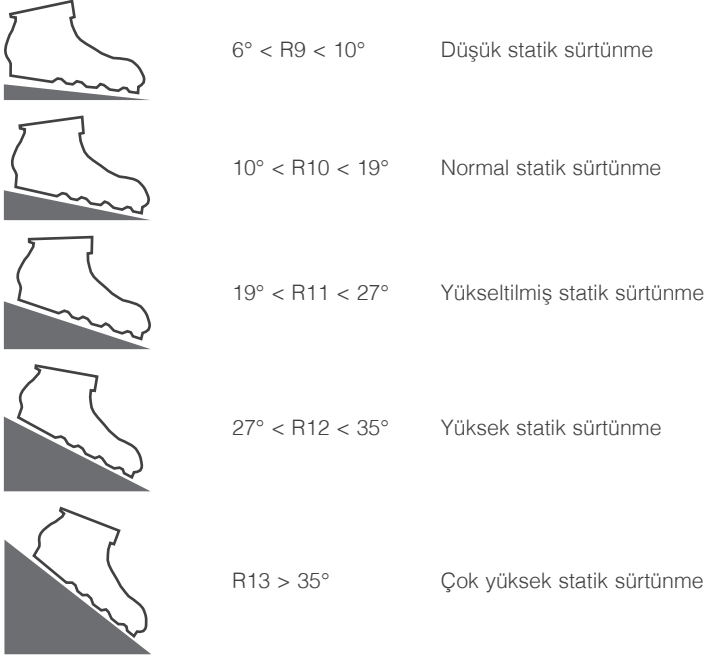

Açık alan testi

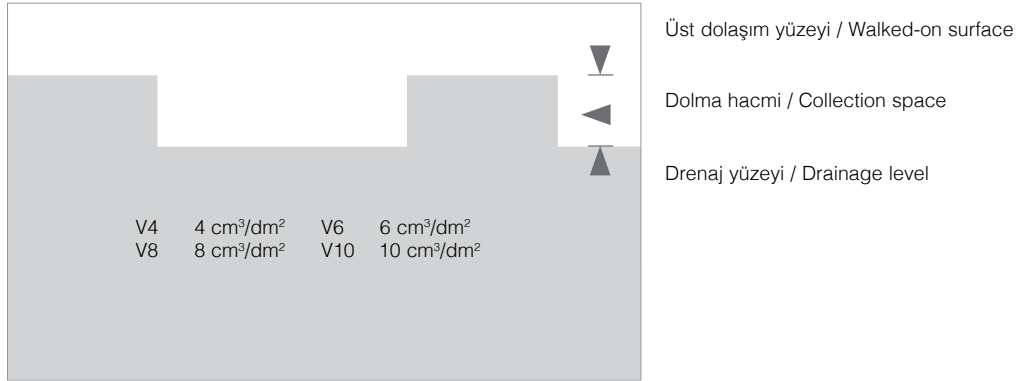

Karo kesiti / Cross-section of tile

ASTM C1028 Test Sonuçları - ASTM C1028 Test Results

Color Group	Dimension	Surface	COF Wet*	COF Dry*	Product Group	Dimension	Surface	COF Wet*	COF Wet*
PRO Technic	All dimensions	Matt R9	≥0,55	≥0,70	Floor & Wall	All dimensions	Matt A	≥0,50	≥0,70
PRO Technic	All dimensions	Matt R10A	≥0,60	≥0,80	Floor & Wall	All dimensions	Polished	≥0,35	≥0,60
PRO Technic	All dimensions	Polished	≥0,40	≥0,60	Floor & Wall	All dimensions	R10B	≥0,60	≥0,80
PRO Technic	All dimensions	Canalı	≥0,70	≥0,80	Floor & Wall	All dimensions	R10A	≥0,60	≥0,80
PRO Technic	All dimensions	Corund	≥0,70	≥0,80	Floor & Wall	All dimensions	R9A	≥0,55	≥0,75
PRO Technic	All dimensions	Diamond	≥0,52	≥0,80	Floor & Wall	All dimensions	-C	≥0,80	≥1,00
PRO Technic	All dimensions	Mercato	≥0,65	≥0,80					
PRO Technic	All dimensions	Kripto	≥0,85	≥0,85					
PRO Technic	All dimensions	Rondo	≥0,60	≥0,80					
PRO Technic	All dimensions	Kanyon	≥0,60	≥0,80					

COF Wet: *It is enounced according to ASTM C1028 test method.
COF Dry: *It is enounced according to ASTM C1028 test method.

Endüstriyel Alanda Kayma Sınıfları Ve Dolma Hacmi - Kullanım Alanları

Industrial Areas Slip Resistance Classification And Collection Space - Application Areas

Nr.	Çalışma alanları, yürüme yolları	Kayma sınıfı (R grupları)	En küçük dolma hacmi	Nr.	Çalışma alanları, yürüme yolları	Kayma sınıfı (R grupları)	En küçük dolma hacmi
0	Genel çalışma odaları			12.5	Tıbbi banyolar, hidroterapi üniteleri	R 11	
0.1	Giriş yerleri (iç)	R 9		12.6	Ameliyathanelerin ve alçıları yıkanma odaları	R 10	
0.2	Giriş yerleri (dış)	R 11 - R 10	V 4	12.7	Tuvaletler, koğuş banyoları	R 10	
0.3	Merdivenler (iç)	R 9		12.8	Masaj odaları, teşhis ve tedavi odaları	R 9	
0.4	Merdivenler (dış)	R 11 - R 10	V 4	12.9	Ameliyathaneler	R 9	
0.5	Tuvaletler, yıkanma yerleri, mola odaları (örn. misafir odaları, kantinler), sağlık odaları	R 10		12.10	Hasta odaları ve koridorlar olan klinikler	R 9	
1	Margarin, yenilebilir sıvı ve katı yağ üretimi			12.11	Muayenehaneler, gündüz klinikleri	R 9	
1.1	Yağın eritilmesi	R 13	V 6	12.12	Eczaneler	R 9	
1.2	Yemelik yağ antımı	R 13	V 4	12.13	Laboratuvarlar	R 9	
1.3	Margarin üretim ve paketlenme	R 12		12.14	Kuaförler	R 9	
1.4	Yemelik yağ üretimi, paketlenme, şişeleme	R 12					
2	Süt prosesi, peynir üretimi			13	Çamaşırhaneler		
2.1	Taze süt işlenmesi ve tereyağı üretimi	R 12		13.1	Kurutmalı (santrifüjli) çamaşır makineleri	R 9	
2.2	Peynir üretimi, depolama ve paketlenme	R 11		13.2	Çok ıslak çamaşırların olduğu yıkama odaları	R 11	
2.3	Dondurma üretimi	R 12		13.3	Ütü ve çamaşır sıkma makinelerinin olduğu odalar	R 9	
3	Çikolata ve şekerleme üretimi			14	Konsantre hayvan yemi üretimi		V 4
3.1	Şekerin işlenmesi	R 12		14.1	Kurutulmuş yem üretimi	R 11	
3.2	Kakao üretimi	R 12		14.2	Su ve yağ kullanılarak kurutulmuş yem üretimi	R 11	
3.3	Ham karışımların üretimleri	R 11		15	Deri üretimi, tekstil		
3.4	Çubuk, kabuk ve içi doldurulmuş çikolata üretimi	R 11		15.1	Tabakhane'deki sulu yerler	R 13	V 10
4	Kek, pasta ve ekmek üretimi			15.2	Deri yüzme makinelerinin olduğu odalar	R 13	
4.1	(Tirnarlar, pastaneler ve uzun dayanımlı unlu mamul üretimi)			15.3	Deri parçalarının toplandığı odalar	R 13	
4.1	Hamur hazırlama	R 11		15.4	Derilerin empreye yapıldığı yerler	R 12	
4.2	Yağlı ve sıvı üretimin ağır bastığı yerler	R 12		15.5	Tekstil için boya değirmenlerinin olduğu yerler	R 11	
4.3	Bulaşık yıkama odası	R 12	V 4	16	Çiğ atölyeleri		
5	Et işleme, kesimhaneler (mezbah)			16.1	Sulu öğütme atölyeleri	R 12	V 10
5.1	Kesim yeri	R 13	V 10	17	Seramik endüstrisi		
5.2	Sakatat temizleme yeri	R 13	V 10	17.1	Islak değirmenler (seramik hammaddenin hazırlanması)	R 11	V 6
5.3	Et parçalama	R 13	V 8	17.2	Kağıncılar, zift, grafit ve sentetik malzemelerin kullanıldığı yerler	R 11	V 6
5.4	Sosis, salam ve sucuk hazırlama	R 13	V 8	17.3	Şekillendirme presleri zift, grafit ve sentetik malzemelerin kullanıldığı yerler	R 11	
5.5	Haşlama bölümü	R 13	V 8	17.4	Dökümhaneler	R 12	
5.6	Ham üretim bölümü	R 13	V 6	17.5	Sıfama	R 12	
5.7	Sucuk, salam, sosis kurutma odası	R 12		18	Cam ve taş prosesi		
5.8	Bağrsak deposu	R 12		18.1	Taş kesme ve öğütme yeri	R 11	
5.9	Tuzlama ve terbiye odası	R 12		18.2	Her türlü cam şekillendirme	R 11	
5.10	Kanaltı işleme	R 12	V 6	18.3	Öğütme yerleri	R 11	V 6
5.11	Soğuk kesim ve paketlenme	R 12	V 8	18.4	İzolasyon camı üretiminde kurutucu malzemelerin işlendiği yerler	R 11	V 6
5.12	Elle işleme ve satış	R 12	V 8	18.5	Düz camın paketlenmesi ve yüklendiği yerler, yapımayı öneleyici malzemelerin hazırladığı yerler	R 11	
6	Balık işleme ve meze üretimi			18.6	Astılı indirme yapılan yerler	R 11	
6.1	Balık işlenmesi	R 13	V 10	19	Prefabrik beton fabrikaları		
6.2	Meze üretimi	R 13	V 6	19.1	Beton yıkama yerleri	R 11	
6.3	Mayonez üretimi	R 13	V 4	20	Stok sahaları		
7	Sebze işlenmesi			20.1	Likit ve katı yağlar için stok sahaları	R 12	V 6
7.1	Sauerkraut üretimi	R 13	V 6	20.2	Paketlenmiş yiyeceklerin stok sahaları	R 10	
7.2	Konserve üretimi	R 13	V 6	20.3	Açık alandaki stok sahaları	R 11 - R 10	V 4
7.3	Sterilizasyon odaları	R 11		21	Demir ve metalin kimyasal ve ısı işleme prosesi		
7.4	Üretim için hazırlama	R 12	V 4	21.1	Beizerler	R 12	
8	Yemek ve içecek üretimindeki ıslak zeminler (özellikle farklı bir şey belirtilmemişse)			21.2	Sertleştirme prosesi	R 12	
8.1	Kilerler, mahzenler	R 10		21.3	Laboratuvarlar	R 11	
8.2	Meşrubat şişeleme ve meyve suyu üretimi	R 11		22	Metal prosesi, metal atölyeleri		
9	Mutfaklar ve pişirme yerleri			22.1	Galvanize atölyeleri	R 12	V 4
9.1	Restoran, otel mutfakları	R 11		22.2	Graugussbearbeitung	R 11	V 4
9.1.1	100 yemek/güne kadar	R 12	V 4	22.3	Mekânik proses (torna, pres yerleri) tel boru çekme yerleri, yağlı ortamdan dolayı riskin fazla olduğu ortamlar	R 11	
9.1.2	100 yemek/gün üzeri	R 11	V 4	22.4	Parça temizleme yerleri, buhar çıkışının olduğu odalar	R 12	
9.2	Evlere, çocuk yuvalarına, sanatoryumlara servis yapan mutfaklar	R 12		23	Araç bakım yerleri		
9.3	Hastane ve klinik mutfakları	R 12		23.1	Bakım ve servis alanı	R 11	V 4
9.4	Üniversite ve büyük fabrikalara servis veren mutfaklar	R 10	V 4	23.2	Çalışma ve kontrol alanı	R 12	V 4
9.5	Yemek hazırlama mutfakları (fast-food, snack bar)	R 12	V 4	23.3	Araç yıkama yerleri	R 11	
9.6	Dondurulmuş ürünlerin istidığı mutfaklar	R 10		24	Uçak bakım atölyeleri		
9.7	Çay ve kahve hazırlama mutfakları, garni mutfağı, koğuş mutfağı	R 12		24.1	Uçak hangarları	R 11	
9.8.1	3.1, 9.4, 9.5 maddelerinin bulaşıkhaneleri	R 11		24.2	Uçak bakım ve tamir hangarları	R 12	V 4
9.8.2	9.2 maddelerinin bulaşıkhaneleri	R 12	V 4	24.3	Uçak yıkama yerleri	R 11	
9.8.3	9.3 maddelerinin bulaşıkhaneleri	R 12		25	Evsel atık işleme istasyonları		
9.9	Yemek odaları, misafir yemek odaları, servis bankosu olan kantinler	R 9		25.1	Pompa odaları	R 12	
10	Soğuk hava ve donmuş gıda depoları			25.2	Sulu atıkların drenajı	R 12	
10.1	Paketlenmemiş malzemeler için	R 12		25.3	Elleme odaları	R 12	
10.2	Paketlenmiş malzemeler için	R 11		25.4	Ayakta durulan yerler ve bekleme odaları	R 12	
11	Satış yerleri, dükkanlar			26	İtalye binaları		
11.1	Et girişi			26.1	Araç parkı	R 12	
11.1.1	Paketlenmemiş malzemeler için	R 11		26.2	Hortum bakım atölyesi	R 12	
11.1.2	Paketlenmiş malzemeler için	R 10		27	Finansal işletmeler		
11.2	Balk girişi	R 11		27.1	Banko önü	R 9	
11.3	Sosis, salam, sucuk ve et için servis geçişi			28	Park alanları		
11.3.1	Paketlenmemiş malzemeler için	R 11		28.1	Garaajlar, yeraltı ve yer üstü otoparkları (hava değişiminin etkilemediği)	R 10	
11.3.2	Paketlenmiş malzemeler için	R 10		28.2	Garaajlar, yeraltı ve yer üstü otoparkları (hava değişiminin etkilediği)	R 11 - R 10	V 4
11.4	Paketlenmemiş ekmek ve unlu mamuller için servis geçişi	R 10		28.3	Açık alan park yerleri	R 11 - R 10	V 4
11.5	Paketlenmemiş süt ürünleri ve meze için servis geçişi	R 10		29	Okullar ve çocuk yuvaları		
11.6	Balk servisi			29.1	Giriş yerleri, koridorlar, toplantı salonları	R 9	
11.6.1	Paketlenmemiş malzemeler için	R 12		29.2	Sınıflar, grup odaları	R 9	
11.6.2	Paketlenmiş malzemeler için	R 11		29.3	Merdivenler	R 9	
11.7	Nr. 11.3'ten 11.6'ya kadar hariç servis geçişleri	R 9		29.4	Tuvaletler, yıkama odaları	R 10	
11.8	Et hazırlama odaları			29.5	Okullardaki eğitimci mutfaklar (bkz. Nr. 9)	R 10	
11.8.1	Nr. 5 hariç et işleme (düzeltme)	R 12	V 8	29.6	Çocuk yuvalarındaki mutfaklar (bkz. Nr. 9)	R 10	
11.8.2	Nr. 5 hariç et işleme (işleme)	R 11		29.7	Ağşap işleme makinelerinin olduğu odalar	R 10	
11.9	Çiçek buketi yapım odaları	R 11		29.8	El sanatları için özel odalar	R 10	
11.10	Sabit firmı olan satış bölgeleri			29.9	Teneffüs alanları	R 11 - R 10	V 4
11.10.1	Unlu mamullerin hazırlanması	R 11		30	Dış mekânlardaki işletmeyle ilgili yollar		
11.10.2	Önceden hazırlanmış unlu mamullerin işlenmesi	R 10		30.1	Yürüme yolları	R 11 - R 10	V 4
11.11	Sabit fritözü ya da ızgarası olan satış bölgeleri	R 12	V 4	30.2	Yükleme rampaları	R 11 - R 10	V 4
11.12	Satış yerleri ve müşteri kabul	R 9		30.3	Örtülü	R 12	V 4
11.13	Self-servis yapan yerlerde yiyecek hazırlama bölümü	R 10		30.2.2	Açık	R 12	
11.14	Kasa ve paketlenme bölümleri	R 9		30.3	Eğik rampalar (örn. tekerlekli sandalyeler, yükleme köprüleri için)	R 12	
11.15	Açık alanda satış bölümleri	R 11 - R 10	V 4	30.4.1	Depo doldurma yerleri	R 12	
12	Sağlık birimleri			30.4.2	Kapalı depo doldurma yerleri	R 11	
12.1	Dezenfekte odaları (ıslak)	R 11					
12.2	Sterilizasyon için ön temizlik yerleri	R 10					
12.3	Diş atk odaları, temiz olmayan hemşirelik hizmetleri	R 10					
12.4	Sektörsürüme	R 10					

Nr.	Working areas, walking corridors	Antislip groups (R classes)	Minimum collection space
0	General working rooms and areas		
0.1	Entrance areas (inside)	R 9	
0.2	Entrance areas (outside)	R 11 - R 10	V 4
0.3	Stairs (inside)	R 9	
0.4	Stairs (outside)	R 11 - R 10	V 4
0.5	Toilets, washrooms	R 10	
	Resting rooms (e.g. Guest lounges, canteens) Sanitation rooms	R 9	
1	Manufacture of margarine, edible fats and oils		
1.1	Melting of fat	R 13	V 6
1.2	Cooking oil refinery	R 13	V 4
1.3	Margarine production and packaging	R 12	
1.4	Cooking fat production and packing, oil bottling	R 12	
2	Milk processing, cheese production		
2.1	Fresh milk processing and butter production	R 12	
2.2	Cheese production, storage and packaging	R 11	
2.3	Icecream manufacturing	R 12	
3	Chocolate and confectionery production		
3.1	Sugar processing	R 12	
3.2	Cocoa production	R 12	
3.3	Production of raw mixtures	R 11	
3.4	Fabrication of chocolate bars, shells and filled chocolates	R 11	
4	Production of bread, cakes and pastries (bakeries, cake shops, production of long-life bakery products)		
4.1	Dough production	R 11	
4.2	Rooms in which predominantly fats or liquid mixtures are processed	R 12	
4.3	Washing-up rooms	R 12	V 4
5	Slaughtering, meat processing		
5.1	Slaughter house	R 13	V 10
5.2	Tripe processing room	R 13	V 10
5.3	Meat sectioning	R 13	V 8
5.4	Sausage kitchen	R 13	V 8
5.5	Boiled sausage unit	R 13	V 8
5.6	Raw sausage unit	R 13	V 6
5.7	Sausage drying room	R 12	
5.8	Smoking establishments	R 12	
5.9	Salting and curing rooms	R 12	
5.10	Poultry processing	R 12	V 6
5.11	Gut store	R 12	
5.12	Cold cuts and packaging unit	R 12	V 8
6	Fish processing, production of delicatessen		
6.1	Fish processing	R 13	V 10
6.2	Production of delicatessen	R 13	V 6
6.3	Manufacture of mayonnaise	R 13	V 4
7	Processing of vegetables		
7.1	Production of sauerkraut	R 13	V 6
7.2	Vegetable tinning	R 13	V 6
7.3	Sterilization rooms	R 11	
7.4	Rooms in which vegetables are prepared for processing	R 12	V 4
8	Food areas in food and beverage production (if not specifically mentioned)		
8.1	Storage cellars	R 10	
8.2	Beverage bottling, fruit juice production	R 11	
9	Catering establishments		
9.1	Kitchens in the catering trade (restaurant kitchens, hotel kitchens)		
9.1.1	Up to 100 meals per day	R 11	V 4
9.1.2	More than 100 meals per day	R 12	V 4
9.2	Catering kitchens serving to homes, schools, kindergartens, sanatoria	R 11	
9.3	Kitchens of hospitals and clinics	R 12	
9.4	Catering kitchens serving to universities and industrial canteens	R 12	V 4
9.5	Food preparation kitchens (fast-food kitchens, snack bars)	R 12	V 4
9.6	Kitchens for heating up frozen meals	R 10	
9.7	Coffee and tea kitchens, hotel garni kitchens and ward kitchens	R 10	
9.8.1	Washing-up rooms for 9.1, 9.4, 9.5	R 12	V 4
9.8.2	Washing-up rooms for 9.2	R 11	
9.8.3	Washing-up rooms for 9.3	R 12	
9.9	Dining rooms, guest rooms, canteens including serving counters	R 9	
10	Cold stores, deep freeze stores		
10.1	For unpacked goods	R 12	
10.2	For packed goods	R 11	
11	Sales outlets, shops		
11.1	Reception of goods, meats		
11.1.1	For unpacked goods	R 11	
11.1.2	For packed goods	R 10	
11.2	Reception of goods, fish	R 11	
11.3	Serving counters for meat and sausage		
11.3.1	For unpacked goods	R 11	
11.3.2	For packed goods	R 10	
11.4	Serving counters for bread, cakes and pastries, unpacked goods	R 10	
11.5	Serving counters for cheese and cheese products, unpacked goods	R 10	
11.6	Serving counters for fish		
11.6.1	For unpacked goods	R 12	
11.6.2	For packed goods	R 11	
11.7	Serving counters from Nr.11.3 to 11.6	R 9	
11.8	Meat preparation rooms		
11.8.1	For meat preparation, except for no.5	R 12	V 8
11.8.2	For meat processing, except for no.5	R 11	
11.9	Florists shops	R 11	
11.10	Sales areas with stationary ovens		
11.10.1	For the production of bread, cakes and pastries	R 11	
11.10.2	For the warming-up of refabricated bread, cakes and pastries	R 10	
11.11	Sales areas with stationary chip pans or grills	R 12	V 4
11.12	Shops, customer rooms	R 9	
11.13	Preparation areas for food and self-service shops	R 10	
11.14	Cash register areas, packing areas	R 9	
11.15	Outdoor sales areas	R 11 - R10	V 4
12	Health service rooms		
12.1	Disinfection rooms (wet)	R 11	
12.2	Pre-cleaning areas of sterilization	R 10	
12.3	Faeces disposal rooms, discharge rooms, unclean nursing work rooms	R 10	
12.4	Pathological facilities	R 10	
12.5	Rooms for medical baths, hydrotherapy, lango preparation	R 11	

Nr.	Working areas, walking corridors	Antislip groups (R classes)	Minimum collection space
12.6	Washrooms of operating theatres, plastering rooms	R 10	
12.7	Sanitary rooms, ward bathrooms	R 10	
12.8	Rooms for medical diagnosis and therapy, massage rooms	R 9	
12.9	Operating theatres	R 9	
12.10	Wards with hospital rooms and corridors	R 9	
12.11	Medical practices, day clinics	R 9	
12.12	Pharmacies	R 9	
12.13	Laboratories	R 9	
12.14	Hairdressing salons		
13	Laundries		
13.1	Rooms with continuous-flow washing machines	R 9	
13.2	Rooms with washing machines or with spin-drier	R 11	
13.3	Ironing rooms	R 9	
14	Fodder concentrate production		
14.1	Dried fodder production	R 11	
14.2	Fodder concentrate production using fat and water	R 11	V 4
15	Leather productions, textiles		
15.1	Wet areas in tanneries	R 13	
15.2	Rooms with fleshing machines	R 13	V 10
15.3	Areas where leather scraps accumulate	R 13	V 10
15.4	Rooms for making leather impermeable by means of grease	R 12	
15.5	Dye mills for textures	R 11	
16	Paint shops		
16.1	Wet grinding areas	R 12	V 10
17	Ceramic industry		
17.1	Wet grinding mills (processing of ceramic, raw materials)	R 11	
17.2	Mixers, handling of materials like tar, pitch, graphite and synthetic resins	R 11	V 6
17.3	Presses (shaping); handling of materials like tar, pitch, graphite and synthetic resins	R 11	V 6
17.4	Moulding areas	R 12	
17.5	Glazing areas	R 12	
18	Glass and stone processing		
18.1	Stone cutting, stone grinding	R 11	
18.2	Glass shaping of hollow glass ware, container ware, glass for building purposes	R 11	
18.3	Grinding areas for hollow glass ware, flat glass	R 11	
18.4	Insulating glass manufacture; handling of drying agents	R 11	V 6
18.5	Packaging, shipping of flat glass, handling of anti-adhesive agents	R 11	V 6
18.6	Etching and acid polishing facilities for glass	R 11	
19	Cast concrete factories		
19.1	Concrete washing areas	R 11	
20	Storage areas		
20.1	Storage areas for oils and fats	R 12	V 6
20.2	Storage areas for packed food	R 10	
20.3	Outdoor storage areas	R 11 - R 10	V 4
21	Chemical and thermal treatment of iron and metal		
21.1	Pickling plants	R 12	
21.2	Hardening shops	R 12	
21.3	Laboratory rooms	R 11	
22	Metal processing, metal workshops		
22.1	Galvanizing shops	R 12	
22.2	Grey cast iron processing	R 11	V 4
22.3	Mechanical processing areas (turnery, milling shop), punching room, pressroom, drawing shop (pipes, wires) and areas exposed to increased stress by oil and lubricants	R 11	V 4
22.4	Parts cleaning areas, exhaust steam areas		
23	Vehicle repair workshops		
23.1	Repair and servicing bays	R 12	
23.2	Working and inspection pits	R 11	V 4
23.3	Car washing halls, washing areas	R 12	V 4
24	Aircraft repair workshops		
24.1	Aircraft hangars	R 11	
24.2	Repair hangars	R 11	
24.3	Washing halls	R 12	V 4
25	Sewage treatment plants		
25.1	Pump rooms	R 11	
25.2	Rooms for sludge draining facilities	R 12	
25.3	Rooms for screening equipment	R 12	
25.4	Stands of workplaces, scaffolds and maintenance platforms	R 12	
26	Fire brigade buildings		
26.1	Vehicle parking places	R 12	
26.2	Rooms for hose maintenance equipment	R 12	
27	Financial institutions		
27.1	Counter areas	R 12	
28	Parking areas		
28.1	Garages, car-parks not exposed to weather influences	R 9	
28.2	Garages, car-parks exposed to weather influences	R 10	V 4
28.3	Open-air parking areas	R 11 - R 10	V 4
29	Schools and kindergartens		
29.1	Entrance areas, corridors, assembly halls	R 11 - R 10	
29.2	Class rooms, group rooms	R 9	
29.3	Stairs	R 9	
29.4	Toilets, washrooms	R 9	
29.5	Instructional kitchens in schools (also see no.9)	R 10	
29.6	Kitchens in kindergartens (also see no.9)	R 10	
29.7	Machine rooms for wood processing	R 10	
29.8	Special rooms for handicrafts	R 10	
29.9	Schoolyards	R 10	V 4
30	Plant traffic routes in outdoor areas		
30.1	Footpaths	R 11 - R 10	
30.2	Loading platforms	R 11 - R 10	
30.2.1	Covered		V 4
30.2.2	Not covered	R 11 - R 10	V 4
30.3	Sloping ramps (e.g. for wheel-chairs, loading platforms)	R 12	
30.4.1	Tank-up areas	R 12	
30.4.2	Tank-up areas, covered	R 12	
		R 11	

CAM KAROLAR DÖŞEME TALİMATI

LAYING INFORMATION FOR GLASS TILES

Cam Karolar Döşeme Talimatı

Kesme/Delme: Lütfen sadece sulu elmas ile kesim yapınız. Delme işlemi sulu, çift yönlü ve düşük devirde yapılmalıdır.

Döşeme: Cam ürünleri döşerken Flex Porcelain Rapid Yapıştırıcı veya Porselen Yapıştırıcı kullanınız. Bronz, Altın ve Platin renkli cam ürünlerin döşemesinde Gri Flex Rapid Yapıştırıcı, diğer tüm renklerde Beyaz Flex Rapid Yapıştırıcı uygulanmalıdır.

Arada hava boşluğu kalmaması için ince dişli tarak kullanılmalıdır.

Ürünlerin yapıştırılmasında silikon kullanmayınız. Döşeme sırasında karonun arka kısmının tamamem yapıştırıcı kaplı olması gerekmektedir.

Uyarı: Cam ürünlerin döşemesinde yapıştırıcı olarak Vitra Fix Flex Rapid veya Porselen yapıştırıcı kullanılması gerekir. Vitra Fix HP ile yapıştırmayınız.

Laying Information for Glass Tiles

Cutting / Perforation: Tiles shall be cut using a cutting saw equipped with a diamond disk and ensuring water supply. Perforation shall be performed in both directions, at low speed and with water supply.

Tile Laying: When laying glass products you should use an adhesive composition for porcelain or Porcelain Rapid (the short-acting adhesive composition for porcelain). When laying glass products of bronze, golden or platinum colors you should use the adhesive composition named Gri Flex Rapid, for products of any other color - the adhesive composition named Beyaz Flex Rapid.

In order to avoid formation of air gaps you should use a fine-tooth comb. In the course of laying the whole back surface of a tile shall be covered with an adhesive composition.

Warning: When laying glass products you should use an adhesive composition for porcelain or Vitra Fix Flex Rapid. Don't use the adhesive composition named Vitra Fix HP.

PARLAK KAROLAR HAKKINDA

A REMINDER ABOUT POLISHED TILES

Parlak karolar hakkında

Parlak karo malzemesi, parlatma işleminden sonra çok yüksek olan teknik özelliklerini korumasına karşın, üst yüzeyinde oluşan mikroskobik gözenekli yapısı lekelenmeyi kolaylaştırır. Ancak estetik kalitesi ve canlı renkliliği nedeniyle tercih edilir. Aynı nedenle oluşan parlak yüzeyin aşınma dayanıklılığı (MOHS) parlatılmamış malzemeninkinden daha düşüktür. Lekelenme durumunda lekenin kalıcı olmaması için hiç bekletmeden özel olarak üretilmiş leke çıkarıcı malzemelerle temizlenmesi gerekmektedir.

Bununla birlikte lekelenmeyi önlemeye yönelik piyasada farklı markalarda yüzey koruyucu ürünler bulunmakta olup, döşeme sonrası bunlarla kaplama yapılabilir. Ayrıca Vitra kullanıma hazır Protect kodlu lekelenmeyi önlemeye yönelik uygulama yapılmış ürünler üretmektedir.

A reminder about polished tiles

Although a polished tile will preserve its superior technical specifications, the formation of its microscopic pores makes it susceptible to staining. For the same reason the surface of the polished material has a lower hardness resistance measure than its matt version on the MOHS scale. In the case of staining it is recommended to use cleaning agents by specialised producers immediately after contact.

There are different kinds of surface protection agents in the market which can be used after the tiles have been laid. Vitra suggests using Protect which is a ready-to-lay application on polished porcelain tiles.

TEMİZLİK VE BAKIM TALİMATI

CLEANING AND MAINTENANCE INSTRUCTION

Temizlik ve Bakım Talimatı

Döşeme Sonrası Temizlik

Döşeme sonrası, yüzeydeki derz film tabakası kısa bir zaman aralığında kurumaya başladığı esnada mutlaka temizlenmeli, yüzeyde sertleşmesine izin verilmemelidir. Bu esnada derzi temizlemek için sadece su ve sünger yeterli olacaktır.

Karo yüzeyinde derz dolgu kalıntılarının sertleşmesi durumunda, bu bölgelere tutunacak kirler, karo yüzeylerinin temizlenmesini zorlaştıracaktır. Bu durumdaki yüzeyler ancak özel kimyasallarla temizlenebilir. Bu tip özel temizleyiciler, kimyasalın üreticisi tarafından belirtilen şekilde kullanılmalıdır. Döşeme sonrası temizliklerde karo yüzeyleri yeterli miktarda suyla durulanmalıdır. Diğer taraftan, yüzeyi asite hassas karolar (metalik yüzeyli vb.), yalnızca su ve nötr temizlik malzemesiyle temizlenmelidir.

Periyodik Rutin Temizlik

Düzenli olarak yapılacak temizliğin sıklığı, karonun döşendiği yerdeki kirlenme potansiyeline ve karonun yüzey özelliğine göre (antislip vb.) bağlı olarak, haftalık, günlük veya günde birkaç kez olacak şekilde değişebilir.

Karolar düzenli olarak vakumlama yöntemiyle ve suyla yıkanarak temizlenmelidir. Ayrıca kirlenme yüküne ve yüzeyine bağlı olarak temizlik deterjanları da kullanılabilir. Suyla temizlik yapıldığında, yüzeyde kalan kirli su, yeterli miktarda temiz su kullanılarak giderilmelidir. Bu durulama, karolar kurduğunda yüzeyde kalabilecek kirliliği önleyecektir. Ayrıca, karo yüzeyleri, temiz bir kuru bez kullanılarak da silinebilir.

Büyük ölçekli alanlar döner, silindirik fırçalı makinelerle temizlenebilir. Bu tip makineler, uygun hıza ayarlanarak, su-deterjan karışımının yüzeye işlemesi sağlanmalıdır. Daha sonra temiz su kullanarak durulama tamamlanmalıdır.

Zaman zaman, yabancı maddeler karo yüzeyinde leke bırakabilir. Böyle durumlarda lekenin özelliğine göre uygun bir temizleyici kullanılarak temizlik yapılmalıdır. Hassas yüzeyli karolar (metalik yüzey gibi) temizlenirken, yalnızca su ve nötr deterjanlar kullanılmalı ve temizlik öncesi kimyasalın yüzeye etkisi küçük bir alanda denenmelidir.

Hidroflorik asit içeren temizleyiciler, seramik yüzeyi parçalama özelliği olduğu için kesinlikle kullanılmamalıdır. Ayrıca, aşındırıcı ekipmanlarla yapılacak uygun olmayan temizlik işlemlerinden, karonun kaymazlık özelliklerini olumsuz yönde etkileyeceği için, kaçınılmalıdır. Bazı temizlik malzemeleri karo yüzeyinde film tabakası bırakabilmektedir; bu tabaka karonun kirlenmesine ve yüzeyin kayganlaşmasına neden olduğundan, bu tip temizleyiciler kullanılmamalıdır.

Cleaning and Maintenance Instruction

Cleaning After Tiling

Once the tiles have been laid, any excess adhesive should be thoroughly removed and not be allowed to set on the tiles. At this stage, the cement layer can be removed using a wetted sponge.

Hardened cement residues can only be removed with special chemical cleaners. Any residual adhesive on the tile surface, will attract dirt which adheres to these residues, and makes the tiles difficult to clean. For this purpose, there exists many types of special cement film removers at the dealers. These cement removers must be used according to the instructions of the producer, after the cleaning the tiles must be rinsed thoroughly with plenty of clean water. Tiles with acid sensitive surfaces (such as metallic) should be cleaned with water and neutral agents only.

Regular Cleaning

The regular cleaning frequency and the method, clearly depends on the soiling load of the tiled area and the surface type of the tile (ie antislip surfaces). In other words, the period of regular cleaning may be changed as weekly, daily or several times in a day, it is directly related with the dirt which is brought in have to be removed

The tiles must be vacuum cleaned regularly, it is also possible to wash down with water occasionally, and you may need to add a commercial cleaning agent depending on the dirt. The dirty water must be removed from the floor entirely, for this reason, the floor should be rinsed with plenty of clean water. This prevents striping when the tiles are dry. The floor may also be cleaned with a dry cloth to remove any remaining dirt.

Especially large areas are most readily cleaned with rotary, cylindrical or reversing mechanical scrubbing machines. Those machines should be used at appropriate speed to permit the water detergent mixture on the floor to penetrate the dirt layer. After scrubbing operation, the process will continue with clean water, for rinsing the removed dirt.

As a precaution, cleaning agents containing hydrofluoric acid and its compounds must not be used, because it attacks ceramic material directly and damages the surface. For the tiles with acid sensitive surfaces (such as metallic surfaces, some specified as "B" in the catalogue), it is recommended to use only neutral detergent and water, before using any detergent, the effect must be checked in a small area. Also inappropriate cleaning such as with abrasive pads may negatively affect the slip-resistance properties. And some cleaning products may leave a film of grease that can attract dirt and make the surface slippery; therefore, using this kind of cleaning products must be avoided.

UNI RENKLER İÇİN EN YAKIN RAL KARŞILIKLARI

THE CLOSEST RAL EQUIVALENTS OF UNI COLORS

Uni Süper Beyaz - Uni Super White	RAL 090 90 10
Uni Süper Siyah - Uni Super Black	RAL 000 20 00
Uni Yeşil - Uni Green	RAL 160 60 15
Uni Turkuaz - Uni Turquoise	RAL 200 50 15
Uni Mavi - Uni Blue	RAL 240 60 20
Uni Kobalt Mavi - Uni Cobalt Blue	RAL 240 40 20
Uni Market Beyaz - Uni Market White	RAL 095 90 10
Uni Fildişi - Uni Ivory	RAL 070 80 10
Uni Kum Beji - Uni Sand	RAL 080 80 10
Uni Grafit Gri - Uni Graphite Grey	RAL 080 40 05
Uni Koyu Vizon - Uni Dark Mink	RAL 060 50 05
Uni Gümüş - Uni Silver	RAL 140 80 05
Uni Çimento Gri - Uni Cement Grey	RAL 100 70 05
Uni Gri - Uni Grey	RAL 000 55 00
Uni Siyah - Uni Black	RAL 000 40 00
Uni Taba - Uni Tobacco	RAL 040 50 20
Uni Moka - Uni Mocha	RAL 050 40 10
Uni Vizon - Uni Mink	RAL 090 60 10
Uni Koyu Mavi - Uni Dark Blue	RAL 240 40 10

Tamamlayıcı parçası veya dekoru olan ürünlerde ana fonu ile ton farklılıkları görülebilir.

For items with complimentary parts or decors, there may occur color tone diversity with plain background.

Sırlı yer karolarının aşınma dirençlerine göre sınıflandırılması (PEI)
Wear-resistance table, glazed (PEI)

I Çok hafif aşınma Very slight wear	III Orta aşınma Average wear	V Çok yüksek aşınma Very high wear
II Hafif aşınma Light wear	IV Yüksek aşınma Higher wear	



NF UPEC normlarına uygun ürünlerimizin ayrıntılı listesini www.cstb.fr web sitesinden bulabilir veya yetkililerden isteyebilirsiniz.

For the detailed list of our products complying with NF UPEC norms, please ask authorized personnel or refer to www.cstb.fr.

Dikkat - Attention

Seramik karoları sipariş ederken kullanım alanlarını belirtiniz.
Seramik karoları döşemedenden önce lütfen tonalite ve kalibre numaralarının aynı mekanlar için aynı olmasına dikkat ediniz; döşendikten sonra sorumluluk kabul edilmez.
Camlı bordürlerde Kraküle (çatlama) olabilir, seramiğin doğasında olan bir unsurdur.
VitrA Karo Seramikleri ile birlikte VitrA Fix derz dolgu ve yapıştırıcı malzemeleri kullanılması önerilir.
Katalogdaki ürün renkleri seramik karoların renklerini aynen yansıtmayabilir.
Tamamlayıcı parçası ve ya dekoru olan ürünlerde ana fonu ile ton farklılıkları görülebilir.
VitrA Karo San. ve Tic. A.Ş.'nin ürünler ve teknik detaylarında değişiklik yapma hakkı saklıdır.

When ordering ceramic tiles specify the areas of use.
Before tile setting, verify the tonality and calibration numbers, claims regarding these indications cannot be accepted after tile setting.
Crazing of glass borders is a nature of the ceramic tiles.
It is recommended to use VitrA Fix grout and adhesive materials with VitrA Ceramic Tiles.
The colors of tiles in the catalogue may not reflect the exact colors of the products.
For items with complimentary parts or decors, there may occur color tone diversity with plain background.
VitrA Karo San. ve Tic. A.Ş. reserves the right to change the products and technical specifications.

Teknik Özellikler Technical Characteristics	Test Metodu Test Standard	PORCELAIN BODY Sırsız / Unglazed	PORCELAIN BODY Sırlı / Glazed	FLOOR TILE BODY Sırlı / Glazed	WALL TILE BODY Sırlı / Glazed
		EN 14411 Group Bla Annex G	EN 14411 Group Bla Annex G	EN 14411 Group Blb Annex H	EN 14411 Group BlII Annex L
		Nominal Size ≥ 15cm	Nominal Size ≥ 15cm	Nominal Size ≥ 15cm	Nominal Size ≥ 15cm

Boyut ve Yüzey Kalitesi / Dimension and surface quality

Uzunluk ve Genişlik / Length and Width	EN ISO 10545-2	± 0,6%	± 2mm	± 0,6%	± 2mm	± 0,6%	± 2mm	± 0,5 %	± 2mm
Kalınlık / Thickness	EN ISO 10545-2	± 5%	± 0,5mm	± 5%	± 0,5mm	± 5%	± 0,5mm	± 10 %	± 0,5mm
Kenar Eğriliği / Straightness of sides	EN ISO 10545-2	± 0,5%	± 1,5mm	± 0,5%	± 1,5mm	± 0,5%	± 1,5mm	± 0,3%	± 1,5mm
Dikdörtgenlik / Rectangularity	EN ISO 10545-2	± 0,5%	± 2mm	± 0,5%	± 2mm	± 0,5%	± 2mm	± 0,5 %	± 2mm
Yüzey Düzgünlüğü / Surface Flatness	EN ISO 10545-2	± 0,5%	± 2mm	± 0,5%	± 2mm	± 0,5%	± 2mm	+ 0,5 % - 0,3 %	± 2mm - 1,5mm
Yüzey Kalitesi / Surface Quality	EN ISO 10545-2	Min. 95 %		Min. 95 %		Min. 95 %		Min. 95 %	

Fiziksel Özellikler / Physical Properties

Su Emme / Water Absorption	EN ISO 10545-3	≤ 0,5 %	≤ 0,5 %	0,5% < E ≤ 3,0 %	E > 10%
Eğilme Dayanımı / Modulus of rupture	EN ISO 10545-4	Min 35 N/mm2	Min 35 N/mm2	Min 30 N/mm2	Min. 15 N/mm2
Kırılma Dayanımı / Breaking Strength	EN ISO 10545-4	Min. 1300 N (t ≥ 7,5mm) Min. 700 N (t < 7,5mm)	Min. 1300 N (t ≥ 7,5mm) Min. 700 N (t < 7,5mm)	Min. 1100 N (t ≥ 7,5mm) Min. 700 N (t < 7,5mm)	Min. 600N (t ≥ 7,5mm) Min. 200 N (t < 7,5mm)
Yüzey Aşınma / Surface Abrasion	EN ISO 10545-7	N.A	As specified in the catalogue	As specified in the catalogue	Not intended to be used on the floor
Derin Aşınma / Deep Abrasion	EN ISO 10545-6	Max. 175 mm3	N.A.	N.A.	N.A.
Lineer Isı Genleşme Linear Thermal Expansion	EN ISO 10545-8	Max 9 x 10 ⁻⁶ K ⁻¹	Max 9 x 10 ⁻⁶ K ⁻¹	Max 9 x 10 ⁻⁶ K ⁻¹	Max 9 x 10 ⁻⁶ K ⁻¹
Isı Şokuna Dayanım Thermal Shock Resistance	EN ISO 10545-9	Başarılı / Pass	Başarılı / Pass	Başarılı / Pass	Başarılı / Pass
Don Dayanımı / Frost Resistance	EN ISO 10545-12	Başarılı / Pass	Başarılı / Pass	Başarılı / Pass	-
Sürtünme Katsayısı / Coefficient of friction	Beyan edilen metod Declared test method	As Specified in the Catalogue	As Specified in the Catalogue	As Specified in the Catalogue	Not intended to be used on the floor
Sırlı karolalarda çatlamaya dayanım Crazing resistance	EN ISO 10545-11	-	Başarılı / Pass	Başarılı / Pass	Başarılı / Pass
Ateşe Dayanıklılık / Reaction to Fire	-	Class A1 or A1FL	Class A1 or A1FL	Class A1 or A1FL	Class A1 or A1FL
Tek renkli karolarda küçük renk farklılıkları Minor colour differences for plain colour tiles	EN ISO 10545-16	ΔE < 1,0	ΔE < 0,75	ΔE < 0,75	ΔE < 0,75

Teknik Özellikler Technical Characteristics	Test Metodu Test Standard	PORCELAIN BODY Sırsız / Unglazed	PORCELAIN BODY Sırlı / Glazed	FLOOR TILE BODY Sırlı / Glazed	WALL TILE BODY Sırlı / Glazed
		EN 14411 Group BII Annex G	EN 14411 Group BII Annex G	EN 14411 Group BII Annex H	EN 14411 Group BIII Annex L
		Nominal Size \geq 15cm	Nominal Size \geq 15cm	Nominal Size \geq 15cm	Nominal Size \geq 15cm

Kimyasal Dayanım / Chemical Resistance

Lekelenmeye Dayanım / Staining resistance	EN ISO 10545-14	Test Metodu bulunur Test Method Available	Sınıf Class	Sınıf Class	Sınıf Class
Ev kimyasalları ve yüzme havuzu temizleyicilerine dayanım / Resistance to household chemicals and swimming pool water cleaners	EN ISO 10545-13	Sınıf Class	Sınıf Class	Sınıf Class	Sınıf Class
Düşük konsantrasyonlu asit ve alkali dayanımı / Resistance to low concentrations acids&alkalis	EN ISO 10545-13	Sınıf Class	Sınıf Class	Sınıf Class	Sınıf Class
Yüksek konsantrasyonlu asit ve alkali dayanımı / Resistance to high concentrations acids&alkalis	EN ISO 10545-13	Sınıf Class	Sınıf Class	Sınıf Class	Sınıf Class



VitrA Karo Sanayi ve Ticaret A.Ş. Şifa mah. Hükümet Cad. Tuzla 34941 İSTANBUL –TURKEY
Info: www.vitra.com.tr
05
DoP No: D200-01

EN 14411:2012

Ürün / Product

Düşük su emmeli kuru preslenmiş seramik karolar Su emme oranı Eb ≤ 0,5% - Grup Bla
Dry-Pressed Ceramic Tiles, with water absorption Eb ≤ 0,5% - Group Bla

Kullanım Alanı / Intended use

İç ve dış mekânda yer ve duvar kaplama
For internal and external walls and flooring



YER KAROSU / FLOOR TILE
DUVAR KAROSU / WALL TILE
DONA DAYANIKLI / FROST RESISTANT

Yangına tepki Reaction to fire Brandverhalten	Sınıf / Class A1 / A1 FL	EN 14411:2012
Açığa çıkan tehlikeli maddeler Release of dangerous substance, for		
- Kadmium / Cadmium	NPD	EN 14411:2012
- Kurşun / Lead	NPD	EN 14411:2012
Kırılma Dayanımı / Breaking Strength (t= kalınlık, thickness)	> 1300 N (t≥ 7,5mm) > 700 N (t< 7,5mm)	EN 14411:2012
Kaymaya Direnç (1) / Slipperiness (1)	Teknik döküman ve kataloglara bakınız See technical documents and catalog Test method / Test Metod CEN/ TS 16165	EN 14411:2012
Hissedilebilir Yüzey / Tactility	NPD	
Bağ Dayanımı – yapışma / Bond strength-adhesion for		
Çimento esaslı yapıştırıcı Tip C2/ For cementitious adhesives Typ C2	≥ 0,5 N/mm ²	EN 14411:2012
Dispersiyon esaslı yapıştırıcı / Dispersion adhesive	NPD	EN 14411:2012
Reaksiyon reçine esaslı yapıştırıcı / Reaction resin adhesive	NPD	EN 14411:2012
Isı Şokuna Dayanım / Thermal Shock Resistance	Geçer / Pass	EN 14411:2012
Dayanıklılık / Durability For		
İç mekân kullanım / Internal Use	Geçer / Pass	EN 14411:2012
Dış mekân kullanım-dona dayanım External Use: Freeze-thaw resistance	Geçer / Pass	EN 14411:2012

(1)
Sadece ilgili ülke mevzuatında gerekiyise
Only if required by corresponding national statutory regulations



Vitra Karo Sanayi ve Ticaret A.Ş. Şifa mah. Hükümet Cad. Tuzla 34941 İSTANBUL –TURKEY
Info: www.vitra.com.tr
05
DoP No: D300-01

EN 14411:2012

Ürün / Product

Düşük su emmeli kuru preslenmiş seramik karolar Su emme oranı %0,5< Eb ≤%3 - Grup BIb
Dry-Pressed Ceramic Tiles, with water absorption 0,5% < Eb ≤ 3 % - Group BIb

Kullanım Alanı / Intended use

İç ve dış mekânda yer ve duvar kaplama
For internal and external walls and flooring



Yangına tepki / Reaction to fire Brandverhalten

Sınıf / Class
A1 / A1 FL

EN 14411:2012

Açığa çıkan tehlikeli maddeler
Release of dangerous substance, for

- Kadmium / Cadmium

NPD

EN 14411:2012

- Kurşun / Lead

NPD

EN 14411:2012

Kırılma Dayanımı / Breaking Strength
(t= kalınlık, thickness)

> 1100 N (t≥ 7,5mm)
> 700 N (t< 7,5mm)

EN 14411:2012

Kaymaya Direnç (1)
Slipperiness (1)

Teknik döküman ve kataloglara bakınız
See technical documents and catalog

Test method
Test Metod
CEN/ TS 16165

EN 14411:2012

Hissedilebilir Yüzey / Tactility

NPD

Bağ Dayanımı – yapışma / Bond strength-adhesion for

Çimento esaslı yapıştırıcı Tip C2
For cementitious adhesives Typ C2

≥ 0,5 N/mm²

EN 14411:2012

Dispersiyon esaslı yapıştırıcı
Dispersion adhesive

NPD

EN 14411:2012

Reaksiyon reçine esaslı yapıştırıcı
Reaction resin adhesive

NPD

EN 14411:2012

Isı Şokuna Dayanım
Thermal Shock Resistance

Geçer / Pass

EN 14411:2012

Dayanıklılık / Durability For

İç mekân kullanım / Internal Use

Geçer / Pass

EN 14411:2012

Dış mekân kullanım-dona dayanım
External Use: Freeze-thaw resistance

Geçer / Pass

EN 14411:2012

(1)
Sadece ilgili ülke mevzuatında gerekiyorsa / Only if required by corresponding national statutory regulations



Vitra Karo Sanayi ve Ticaret A.Ş. Şifa mah. Hükümet Cad. Tuzla 34941 İSTANBUL –TURKEY
Info: www.vitra.com.tr
05
DoP No: D100-01

EN 14411:2012

Ürün / Product

Düşük su emmeli çekme seramik karolar, su emme oranı $E_b \leq 0,5\%$ - Grup Ala
Extruded Ceramic Tiles, with water absorption $E_b \leq 0,5\%$ - Group Ala

Kullanım Alanı / Intended use

İç ve dış mekânda yer ve duvar kaplama
For internal and external walls and flooring



Yangına tepki / Reaction to fire Brandverhalten	Sınıf / Class A1 / A1 FL	EN 14411:2012
Açığa çıkan tehlikeli maddeler / Release of dangerous substance, for		
- Kadmiyum / Cadmium	NPD	EN 14411:2012
- Kurşun / Lead	NPD	EN 14411:2012
Kırılma Dayanımı / Breaking Strength (t= kalınlık, thickness, dicke, épaisseur)	> 1300 N ($t \geq 7,5\text{mm}$) > 600 N ($t < 7,5\text{mm}$)	EN 14411:2012
Kaymaya Direnç (1) / Slipperiness (1)	Teknik döküman ve kataloglara bakınız See technical documents and catalog Test method / Test Metod CEN/ TS 16165	EN 14411:2012
Hissedilebilir Yüzey / Tactility	NPD	
Bağ Dayanımı – yapışma / Bond strength-adhesion for		
Çimento esaslı yapıştırıcı Tip C2/ For cementitious adhesives Typ C2	$\geq 0,5 \text{ N/mm}^2$	EN 14411:2012
Dispersiyon esaslı yapıştırıcı / Dispersion adhesive	NPD	EN 14411:2012
Reaksiyon reçine esaslı yapıştırıcı / Reaction resin adhesive	NPD	EN 14411:2012
Isı Şokuna Dayanım / Thermal Shock Resistance	Geçer / Pass	EN 14411:2012
Dayanıklılık / Durability For		
İç mekân kullanım / Internal Use	Geçer / Pass	EN 14411:2012
Dış mekân kullanım-dona dayanım / External Use: Freeze-thaw resistance	Geçer / Pass	EN 14411:2012

(1)
Sadece ilgili ülke mevzuatında gerekiyorsa / Only if required by corresponding national statutory regulations



VitrA Karo Sanayi ve Ticaret A.Ş. Şifa mah. Hükümet Cad. Tuzla 34941 İSTANBUL –TURKEY
Info: www.vitra.com.tr
05
DoP : D400-01

EN 14411:2012

Ürün / Product

Kuru preslenmiş seramik karolar, su emme oranı Eb > %10 - Grup BIII
Dry-Pressed Ceramic Tiles, with water absorption Eb > 10 % - Group BIII

Kullanım Alanı / Intended use

İç ve dış mekânda yer ve duvar kaplama
For internal and external walls and flooring



DUVAR KARBOSU
WALL TILE

Yangına tepki / Reaction to fire Brandverhalten	Sınıf / Class A1	EN 14411:2012
Açığa çıkan tehlikeli maddeler / Release of dangerous substance, for		
- Kadmiyum / Cadmium	NPD	EN 14411:2012
- Kurşun / Lead	NPD	EN 14411:2012
Kırılma Dayanımı / Breaking Strength (t= kalınlık, thickness)	> 600 N (t≥ 7,5mm) > 200 N (t< 7,5mm)	EN 14411:2012
Bağ Dayanımı – yapışma / Bond strength-adhesion for		
Çimento esaslı yapıştırıcı Tip C1 For cementitious adhesives Typ C1	≥ 0,5 N/mm ²	EN 14411:2012
Dispersiyon esaslı yapıştırıcı / Dispersion adhesive / Dispersionsklebstoffe	NPD	EN 14411:2012
Reaksiyon reçine esaslı yapıştırıcı / Reaction resin adhesive	NPD	EN 14411:2012
Isı Şokuna Dayanım / Thermal Shock Resistance	Geçer / Pass	EN 14411:2012
Dayanıklılık / Durability For		
İç mekân kullanım / Internal Use	Geçer / Pass	EN 14411:2012

CERTIFICATE OF COMPLIANCE



VitrA Karo San. ve Tic.
A.S.

Arkitekt Color Floor & Wall Tiles

79012410
Certificate Number

08/03/2015 - 08/03/2017
Certificate Period

Certified
Status

UL 2818 - 2013 Gold Standard for Chemical Emissions for Building Materials, Finishes and Furnishings

Wall Tiles are determined compliant in accordance with California Department of Public Health (CDPH) Standard Method 0115-2005 using an Open-Flow Environment with an air change of 4.0/h and a loading of 100 kg/m² and Wall Tiles are determined compliant in accordance with California Department of Public Health (CDPH) Standard Method 0115-2005 using an Open Environment with an air change of 4.0/h and a loading of 25 kg/m².

Product tested in accordance with UL 2818 test method for these compliance determined limits for UL 2818 Section 1.1 and 1.2.



Environment

A GreenGuard certification represents a review of the certified product by an authorized laboratory in order to determine compliance with the applicable standard and associated testing protocol in order to ensure compliance with the applicable standard. The certificate is valid for the duration of the agreement. The certificate is valid for the duration of the agreement.

GREENGUARD Gold Certification Criteria for Building Products and Interior Finishes

Criteria	CAS Number	Maximum Allowable Predicted Concentration	Units
TVOC ⁽¹⁾	-	0.25	mg/m ³
Formaldehyde	50-99-8	0.07 (0.05)	µg/m ³
Total Aldehydes ⁽²⁾	-	0.063	ppm
4-Phenylcyclohexene	4954-15-5	0.5	µg/m ³
Particle Matter less than 10 µm ⁽³⁾	-	40	µg/m ³
γ-Methyl-γ-pyrrolidone ⁽⁴⁾	874-50-4	150	µg/m ³
Individual VOCs ⁽⁵⁾	-	100000 or 15000 TLV	-

- Defined to be the sum response of measured VOCs falling within the 1 - 10 range, with response adjusted to volatile organic.
- The sum of all measured normal aldehydes from formaldehyde through nonanal, plus benzaldehyde, individually adjusted to a compound specific standard. Nonanal through nonanal are measured via TOC/OA/NL analysis and the remaining aldehydes are measured using HPLC/MS analysis.
- Particle emission requirement only applicable to HVAC Duct Products with exposed surface area from streams (as formed or test) with specific test method and for wood finishing (painting) systems.
- Based on the EPA-Prop. 66 Maximum Allowable Dose level for inhalation of 1000 µg/day and an inhalation rate of 20 m³/day.
- Allowable levels for chemicals not listed are derived from the level of 1/10 the California Office of Environmental Health Hazard Assessment (OEHHA) Chronic Reference Exposure (CRE) (10E1) as indicated per the OEHHA Standard Method (1.1) and BMAA level (with 1.8.2 and 1.10005) or the Permitted Limit Value (TLV) industrial work place standard (Reference: American Conference of Government Industrial Hygienists, 6300 Corvallis, Building D-1, and Cincinnati, OH 45424-9448).



Environment

A GreenGuard certification represents a review of the certified product by an authorized laboratory in order to determine compliance with the applicable standard and associated testing protocol in order to ensure compliance with the applicable standard. The certificate is valid for the duration of the agreement. The certificate is valid for the duration of the agreement.

CERTIFICATE OF COMPLIANCE



VitrA Karo San. ve Tic.
A.S.

Arkitekt Porcelain Floor Tiles

79013430
Certificate Number

08/03/2015 - 08/03/2017
Certificate Period

Certified
Status

UL 2818 - 2013 Gold Standard for Chemical Emissions for Building Materials, Finishes and Furnishings

Wall Tiles are determined compliant in accordance with California Department of Public Health (CDPH) Standard Method 019-3000 using an Office Environment with an air change of 4.0/h and a loading of 100 kg/m² and Wall Tiles are determined compliant in accordance with California Department of Public Health (CDPH) Standard Method 019-3000 using an Office Environment with an air change of 4.0/h and a loading of 25 kg/m².

Product tested in accordance with UL 2818 test method for these compliance determined limits for UL 2818 Section 1.1 and 1.2.



Environment

A UL Environmental Compliance Determination Certificate is the evidence of compliance of the applicable products to the applicable standards or other requirements of standards and the agreement, and any applicable program rules and/or other standards or requirements for the applicable program. The certificate is valid for the duration of the agreement. The certificate is valid for the duration of the agreement.

GREENGUARD Gold Certification Criteria for Building Products and Interior Finishes

Criteria	CAS Number	Maximum Allowable Predicted Concentration	Units
TVOC ⁽¹⁾	-	0.25	mg/m ³
Formaldehyde	50-99-8	0.07 (ppb)	µg/m ³
Total Aldehydes ⁽²⁾	-	0.063	ppm
4-Phenylcyclohexene	4994-15-5	0.5	µg/m ³
Particle Matter less than 10 µm ⁽³⁾	-	40	µg/m ³
γ-Methyl-γ-pyrrolidone ⁽⁴⁾	874-50-4	150	µg/m ³
Individual VOCs ⁽⁵⁾	-	100 ppb or 1/1000 TLV	-

- (1) Defined to be the sum response of measured VOCs falling within the 1 - 10 range, with response calibrated to volatile surrogates.
- (2) The sum of all measured normal aldehydes from formaldehyde through nonanal, plus benzaldehyde, individually calibrated to a compound specific standard. Nonanal through nonanal are measured via TOC/OC/NIR analysis and the remaining aldehydes are measured using HPLC/MS analysis.
- (3) Particle emission requirement only applicable to HVAC Duct Products with exposed surface area in air streams (as found or test) with specific test method and for wood finishing (painting) systems.
- (4) Based on the EPA-Prop. 66 Maximum Allowable Dose level for inhalation of 1,000 µg/day and an inhalation rate of 20 m³/day.
- (5) Allowable levels for chemicals not listed are derived from the level of 1/10 the California Office of Environmental Health Hazard Assessment (OEHHA) Chronic Reference Exposure Level (REL) as indicated per the OEHHA Standard Method (1.1) and BINA level (with 1.8.2 and 1.10.005) or the Permitted Limit Value (TLV) industrial work place standard (Reference: American Conference of Government Industrial Hygienists, 6300 Corvallis, Building D-1, and Cincinnati, OH 45212-9448).



Environment

A UL Environmental Compliance Determination Certificate is the evidence of compliance of the applicable products to the applicable standards or other requirements of standards and the agreement, and any applicable program rules and/or other standards or requirements for the applicable program. The certificate is valid for the duration of the agreement. The certificate is valid for the duration of the agreement.

CERTIFICATE OF COMPLIANCE



VitrA Karo San. ve Tic.
A.S.
Mozaic Tiles

79014420
Certificate Number

08/31/2025 - 08/31/2027
Certificate Period

Certified
Status

UL 2898 - 2013 Gold Standard for Chemical Emissions for Building Materials, Finishes and Furnishings

Wall Tiles are determined compliant in accordance with California Department of Public Health (CDPH) Standard Method 0113-2005 using a Desiccant Environment with an exchange of 4 L/hr and a loading of 100 kg/m² and Wall Tiles are determined compliant in accordance with California Department of Public Health (CDPH) Standard Method 0113-2005 using an OPR Environment with an exchange of 4 L/hr and a loading of 10 kg/m².

Product tested in accordance with UL 2898 test method for these compliance assessment limits for UL 2898, Section 1.4 and 1.5.



Environment

UL is a registered certification organization under the authority of the state of Illinois. UL is not a government agency and does not have the authority to enforce any laws or regulations. The product model is certified to UL 2898. UL is not responsible for the product's performance or safety. The product is used for the specified uses only. UL is not responsible for the product's performance or safety.

GREENGUARD Gold Certification Criteria for Building Products and Interior Finishes

Criteria	CAS Number	Maximum Allowable Predicted Concentration	Units
TVOC ⁽¹⁾	-	0.24	mg/m ³
Formaldehyde	50-00-0	501.3 ppb ⁽²⁾	µg/m ³
Total Aldehydes ⁽³⁾	-	0.643	ppm
4-Phenylcyclohexene	4994-15-5	0.5	µg/m ³
Particle Matter less than 10 µm ⁽⁴⁾	-	20	µg/m ³
γ-Methyl-γ-pyrrolidone ⁽⁵⁾	874-50-4	150	µg/m ³
Individual VOCs ⁽⁶⁾	-	100 ppb or 1,000n TLV ⁽⁷⁾	-

- (1) Defined to be the total response of measured VOCs falling within the 0.1 - 1.0 range, with response calibrated to a volatile surrogate.
- (2) The sum of all measured formal aldehydes from formaldehyde through hexanal, plus benzaldehyde. Individually calibrated to a compound specific standard. Hexanal through hexanal are measured via TOC/CO/NAL analysis and the remaining aldehydes are measured using HPLC/UV analysis.
- (3) Particle emission requirement only applicable to HVOC Dust Products with exposed surface area in air streams (a forced air test with specific test method) and for wood finishing (sanding) systems.
- (4) Based on the EPA Fine PM Maximum Allowable Dose level for inhalation of 5,000 µg/day and an inhalation rate of 20 m³/day.
- (5) Allowable levels for chemicals not listed are derived from the levels of UL's California Office of Environmental Health Hazard Assessment (OEHHA) Chronic Reference Exposure Level (CREL) as required per the SOPVMS/Standard Method v1.1 and BPA level (per 1.8.2 and 1.10.005) of the Revised Limit Value (TLV) industrial/work place standard (Reference: American Conference of Government Industrial Hygienists, 6500 Corporate Building Dr., and Cincinnati, OH 45242-9938).



Environment

UL is a registered certification organization under the authority of the state of Illinois. UL is not a government agency and does not have the authority to enforce any laws or regulations. The product model is certified to UL 2898. UL is not responsible for the product's performance or safety. The product is used for the specified uses only. UL is not responsible for the product's performance or safety.

ENVIRONMENTAL PRODUCT DECLARATION

as per ISO 14025

Owner of the Declaration	Eczacıbaşı Vitra Tiles Co
Programme holder	Institut Bauen und Umwelt (IBU)
Publisher	Institut Bauen und Umwelt (IBU)
Declaration number	EPD-ECZ-2013311-EN
Issue date	26.04.2013
Valid to	25.04.2018

Porcelain Tiles
Eczacıbaşı Vitra Karo San. ve Tic. A. Ş.



Institut Bauen
und Umwelt e.V.

www.ibu-umwelt.com



EU Ecolabel Certificate

NSAI has awarded the
EU Ecolabel licence number IE/21/001 to:

Vitra Karo Sanayi Ve Ticaret A.S.
Eskisehir Yolu, 4 km. Bozuyuk 11300, Bilecik, Turkey

Hard Floor Coverings
(as described in attached annex)
See product specification in standard contract.

This contract is valid until 30 November 2017

Dublin, 06 September 2013
NSAI





DIN EN ISO 50001:2001



ISO 9001:2015



OHSAS 18001:2007



ISO 14001:2014

VitrA